

*Metropolitan Washington Council of Governments*  
*National Capital Region Transportation Planning Board*

# Highway and Transit Networks for the Version 2.3.57a Travel Model, based on the 2015 CLRP and FY 2015-2020 TIP

---

## Final Report

March 18, 2016

This publication was funded, in part, by grants from the District of Columbia Department of Transportation, the Maryland Department of Transportation, the Virginia Department of Transportation, the Federal Highway Administration and the Federal Transit Administration. The material herein does not necessarily reflect the views of the sponsoring agencies.

<b>Title</b> <i>Highway and Transit Networks for the Version 2.3.57a Travel Model, based on the 2015 CLRP and FY 2015-2020 TIP</i>	<b>Date</b>	March 18, 2016
	<b>No. of pages</b>	100
	<b>Publication no.</b>	
<b>Agency</b> National Capital Region Transportation Planning Board		
<p>Transportation planning at the regional level in the Washington, D.C. metropolitan area is coordinated by the National Capital Region Transportation Planning Board (NCRTPB or simply TPB), the federally designated Metropolitan Planning Organization (MPO) for the region. The TPB is staffed by the Department of Transportation Planning (DTP) at the Metropolitan Washington Council of Governments (MWCOG or simply COG). COG is an independent, nonprofit association composed of elected officials from 21 local governments, members of the Maryland and Virginia state legislatures, and members of the U.S. Congress.</p>		
<b>Credits</b>		
Program Administration:	Ronald Milone, Travel Forecasting Program Director	
Authors/Contributors:	Ronald Milone, Meseret Seifu, Jim Yin, Mark Moran, Wanda Hamlin, Joseph Davis, Jane Posey, William Bacon	
<b>Abstract:</b>		
<p>This report describes the development of the transportation networks that are used as inputs to the regional travel demand model developed by the TPB. These networks are compliant with the Version 2.3.57a Travel Model, and are based on the assumptions in the 2015 Financially Constrained Long-Range Transportation Plan (CLRP) and the FY 2015-2020 Transportation Improvement Plan (TIP). The area covered by this travel model, and its associated transportation networks, includes the District of Columbia, neighboring parts of Maryland, Virginia, and one county in West Virginia. The 6,800-square-mile modeled area is divided into 3,722 transportation analysis zones (TAZs). The Version 2.3.57a model became the adopted regional model through actions taken by the TPB on October 21, 2015. The TPB Travel Forecasting Subcommittee provided oversight for the development of the Version 2.3 Travel Model and associated transportation networks.</p>		
<b>Copies of this report can be found on the MWCOG Website:</b>		
<a href="http://www.mwcog.org">www.mwcog.org</a> Metropolitan Washington Council of Governments 777 N. Capitol Street, N.E., Suite 300 Washington, D.C. 20002-4239 Tel. (202) 962-3200		

## Table of Contents

Chapter 1	Introduction .....	1-1
1.1	Annual Air Quality Conformity Process.....	1-2
1.2	Network Development Program Overview .....	1-3
1.3	Report Structure .....	1-4
Chapter 2	TPB Transportation Network Background .....	2-1
2.1	Study Area.....	2-1
2.2	Time of Day Considerations .....	2-1
2.3	Zone Area System .....	2-3
2.4	Highway Network Elements.....	2-8
2.5	Transit Network Elements .....	2-9
2.6	Overview of Network Travel Costs .....	2-10
2.7	Node Numbering System .....	2-11
Chapter 3	Cube Voyager Network Inputs .....	3-1
3.1	Cost Deflation Inputs .....	3-1
3.2	Highway Network Files .....	3-3
3.2.1	Zonal land use .....	3-5
3.2.2	Highway Link and Node Coordinate Files .....	3-6
3.2.3	Roadway functional classification and the facility-type variable.....	3-7
3.2.4	Other link attributes.....	3-9
3.2.5	Toll Parameter File.....	3-10
3.2.6	Highway Network Screenlines .....	3-22
3.2.7	2015 CLRP Highway Statistics .....	3-24
3.3	Transit Network Files .....	3-26
3.3.1	Transit and Non-Transit Mode Codes .....	3-27
3.3.2	Rail Station File.....	3-30
3.3.3	Walk- and Drive-Access to Transit .....	3-32
3.3.4	Station Coordinate Files.....	3-37
3.3.5	Transit Parking Lot Coordinate Files .....	3-37
3.3.6	Rail Links.....	3-38
3.3.7	Transfer Links .....	3-39

3.3.8 Transit Line/Route Files .....	3-40
3.3.9 Example of network coding .....	3-42
3.3.10 Transit route summaries.....	3-44
3.4 Transit path building .....	3-53
3.5 Transit Fare Files .....	3-54
3.5.1 Gathering fare data from the transit providers .....	3-54
3.5.2 Calculating zone-to-zone fares used by the model.....	3-54
Chapter 4 COG/TPB Multi-Year and Multi-Modal Geodatabase .....	4-1
4.1 Geodatabase Overview and Editor .....	4-1
4.2 Geodatabase Tables Overview .....	4-5
4.2.1 Transit Network Tables .....	4-11
4.3 General Transit Feed Specification (GTFS) Data .....	4-13

## List of Tables

Table 1-1 Schedule for the 2015 CLRP and FY2015-2020 TIP .....	1-3
Table 2-1 Jurisdictional summary of 3,722 TPB TAZ ranges .....	2-5
Table 2-2 Differences between COG TAZ and TPB TAZ area systems.....	2-5
Table 2-3 TAZ/node numbering system overview.....	2-11
Table 2-4 Node numbering system for transit nodes .....	2-12
Table 2-5 Allocated highway node ranges by jurisdiction .....	2-12
Table 3-1 Listing of highway network input files .....	3-4
Table 3-2 Format description of the land use file (zone.dbf) .....	3-5
Table 3-3 Round 8.4 Cooperative Forecasts regional totals by year .....	3-6
Table 3-4 Base highway link file description (link.dbf) .....	3-6
Table 3-5 : Highway node file description .....	3-7
Table 3-6: Limit codes.....	3-7
Table 3-7 Area-type codes, from 1 to 7, based on population and employment density.....	3-10
Table 3-8 Toll parameter file (Toll_esc.dbf).....	3-11
Table 3-9 Dulles Toll Road (VA 267): Toll inks.....	3-13
Table 3-10 Dulles Greenway Toll inks (Segments 1-4).....	3-14
Table 3-11 Dulles Greenway Toll inks (Segments 5-8).....	3-15
Table 3-12 Harry W. Nice Bridge toll links .....	3-16
Table 3-13 Toll values on I-495 Capital Beltway in Virginia (in 2015 cents) - 2015 CLRP .....	3-17
Table 3-14 Toll values on I-395/I-95 Virginia (in 2015 cents) - 2015 CLRP .....	3-18
Table 3-15 Toll values on I-66 Inside the Capital Beltway (in 2015 cents) - 2015 CLRP.....	3-19
Table 3-16 Toll values on I-66 Outside the Capital Beltway (in 2015 cents) - 2015 CLRP.....	3-20
Table 3-17 AM lane-miles for 2015 CLRP and FY2015-2020 TIP highway networks .....	3-25

Table 3-18 Listing of transit network input files.....	3-26
Table 3-19 Transit mode codes .....	3-28
Table 3-20 Detailed equivalency of transit mode codes and transit operators .....	3-29
Table 3-21 Non-transit mode codes .....	3-30
Table 3-22 Variables in the transit station file (Station.dbf) .....	3-31
Table 3-23 Transit access distance codes (NCT) .....	3-31
Table 3-24 Station centroid and station node range by mode.....	3-32
Table 3-25 Header section for each transit route in a transit line file.....	3-42
Table 3-26 AM peak-period Metrorail line summary by year: 2015, 2017, 2020, and 2025.....	3-45
Table 3-27 Off-peak period Metrorail line summary by year: 2015, 2017, 2020, and 2025 .....	3-46
Table 3-28 AM peak-period commuter rail summary by year: 2015, 2017, and 2020.....	3-47
Table 3-29 AM peak-period commuter rail summary by year: 2025 and 2030.....	3-48
Table 3-30 Off-peak-period commuter rail summary by year: 2015, 2017, 2020, and 2025 .....	3-49
Table 3-31 AM peak-period Light Rail / BRT Streetcar summary by year: 2015, 2017, 2020, 2025, and 2030.....	3-50
Table 3-32 Off-peak-period Light Rail / BRT Streetcar summary by year: 2015, 2017, 2020, 2025, 2030 .....	3-51
Table 3-33 Number of transit lines and line miles coded in networks: 2015, 2017, 2020, 2025 and 2030 .....	3-52
Table 3-34 Metrorail fare structure, WMATA Tariff #33v2 .....	3-56
Table 3-35 File format: File relating bus fare zones to TAZs and Metrorail stations (TAZFRZN.ASC) .....	3-62
Table 3-36 AM Peak and Off-Peak Bus Fare Matrix between MWCOC Fare Zones (Expressed in 2014 cents) .....	3-63
Table 3-37 Listing of Transit Fare Input Files .....	3-65
Table 4-1 Network Links Feature Class table with "Link Type" codes (1-16) description.....	4-8
Table 4-2 Network Nodes Feature Class table with "Node Type" codes (1-13) description .....	4-9
Table 4-3 Base Links Table with "Mode" codes (1-16) description .....	4-10
Table 4-4 Transit Links Table .....	4-11
Table 4-5 Transit Route Stops Table .....	4-11
Table 4-6 Transit Lines Definition Table .....	4-12
Table 4-7 GTFS files.....	4-14
Table 4-8 Availability of GTFS data for transit operators in the Washington, D.C. area .....	4-14

## List of Figures

Figure 2-1 COG/TPB modeled area – 3,722-zone area system.....	2-2
Figure 2-2 Location of external stations in the modeled area.....	2-6
Figure 2-3 Location of external stations in Baltimore Beltway area.....	2-7
Figure 3-1 Cost deflation parameter file (CPI_File.txt) .....	3-2
Figure 3-2 Projected CPI escalation at varying annual growth rates.....	3-3
Figure 3-3 Deflation process in the Version 2.3 Travel Model .....	3-3
Figure 3-4 Highway network construction process .....	3-4
Figure 3-5 Classification of roads and their emphasis on mobility and access.....	3-8
Figure 3-6 Example of different types of roads .....	3-9
Figure 3-7 Dulles Toll Road: Toll facilities locations.....	3-12
Figure 3-8 Dulles Greenway: Toll facilities locations (Map 1 of 2).....	3-14
Figure 3-9 Dulles Greenway: Toll facilities locations (Map 2 of 2).....	3-15

Figure 3-10 I-66 inside the Capital Beltway: Express Lane Facility .....	3-19
Figure 3-11 I-66 outside the Capital Beltway: Express Lane Facility.....	3-20
Figure 3-12 Existing and Future Managed-lane facilities whose toll varies by time of day.....	3-21
Figure 3-13 Highway Network screenlines: Inside the Beltway.....	3-22
Figure 3-14 Highway network screenlines: Outside the Beltway .....	3-23
Figure 3-15 Process for developing walk-access and drive-access links.....	3-33
Figure 3-16 An excerpt from the AreaWalk.txt file.....	3-34
Figure 3-17 Walk access/egress links in TAZ 56, east of Foggy Bottom Metrorail Station.....	3-35
Figure 3-18 Drive-access links associated with the Ballston Metrorail Station PNR lot .....	3-36
Figure 3-19 Excerpt from the Metrorail station coordinate file (met_node.tb).....	3-37
Figure 3-20 An excerpt of the Metrorail PNR lot coordinate file (met_pnrn.tb).....	3-38
Figure 3-21 An excerpt of the Metrorail rail link file (met_link.tb) .....	3-39
Figure 3-22 An excerpt from the file (met_bus.tb) containing transfer links (mode 12) between Metrorail stations and bus stops.....	3-40
Figure 3-23 Example of a transit line/route file in TRNBUILD (TB) format .....	3-41
Figure 3-24 Existing MWCOG/TRNBUILD convention for network coding around rail stations, park-and-ride lots, and bus service .....	3-43
Figure 3-26 Process for conducting transit path building.....	3-53
Figure 3-27 Metrorail fare structure, WMATA Tariff #33v2: Adjustments made for input to model .....	3-57
Figure 3-28 Metrorail fares (peak and off-peak) and the rail-to-bus discounts (Tariff.txt) .....	3-57
Figure 3-29 Regional Primary Bus Fare Zone Map.....	3-59
Figure 3-30 Regional Secondary Bus Fare Zone Map .....	3-60
Figure 3-31 Combine bus fare zones (primary overlaid with secondary).....	3-61
Figure 3-32 Process for developing zone-to-zone transit fares.....	3-64
Figure 4-1 Relationship Between the GDB and the Cube Voyager Modeling Process .....	4-2
Figure 4-2 TPB Geodatabase Structure.....	4-6
Figure 4-3 Process for combining GTFS data into the COG Geodatabase .....	4-16

## **Chapter 1 Introduction**

The TPB's travel forecasting model requires input data that describe the physical features and operating policies of the region's transportation infrastructure. These data are collectively known as transportation networks. Transportation networks depict the highway and transit system for a series of discrete years, typically an existing "base" year and several forecast years. Transportation networks are used in the travel model to formulate impedances (travel times and costs) between origins and destinations. The travel model considers impedances as a basis for estimating the number of person trips that travel between zones and for allocating those person trips among specific modes of travel. Transportation networks also provide a basis upon which the performance of the existing and planned regional transportation system may be evaluated.

Transportation networks are prepared with attention to a number of technical requirements:

- Networks are designed to represent the major transportation facilities and services that are relevant to the regional level of analysis. Thus, many local facilities and features are purposefully excluded;
- Networks are designed to conform to a detailed area (or zone) system that is specifically designed for regional modeling. The existing area system for the Washington, D.C. area consists of 3,722 zones;
- Networks are designed to meet the specific technical requirements of the Version 2.3 Travel Model. The travel model currently requires network inputs that are used to develop travel highway and transit impedances between zones. The travel model requires modal travel impedances associated with both peak and off-peak operating conditions; and
- Networks are prepared in a format that is compliant with the specific requirements of the software platform that is currently used to apply the model. The Version 2.3 Travel Model is currently implemented with Citilabs Cube Voyager software.

Because of the technically specialized nature of the model's transportation networks, substantial staff resources are required to develop and manage these travel model inputs each year. The network development activity is included in the TPB's Unified Planning Work Program (UPWP) under section 4A. This activity includes an annual update of the current-year highway and transit networks with the most up-to-date information, as well as the development of future year networks that represent the continuously evolving Constrained Long-Range Transportation Plan (CLRP) and the Transportation Improvement Program (TIP), which is a six-year subset of the CLRP. The network development activity also supports other elements of the work program, including Air Quality Conformity (section 3A of the UPWP) and Technical Assistance (section 6), which encompasses subarea and corridor studies conducted by TPB staff and by state and local planning agencies.

This technical report documents the travel demand model transportation networks that were used in the recent Air Quality Conformity Determination of the 2015 CLRP and FY 2015-2020 TIP.<sup>1</sup> As stated

---

<sup>1</sup> Adopted by the TPB on October 21, 2015

earlier, transportation network files are developed in compliance with the adopted travel demand model and its associated software. The currently adopted TPB travel demand model is known as Version 2.3.57a. The travel model uses an area system with 3,722 TAZs and is currently applied using Citilabs Cube Voyager (Version 6.1 SP1).

This document focuses on the process, technical conventions and specifications associated with the TPB's network-related inputs to the travel model. There are other supporting documents that are directly related to the 2015 CLRP network development process and specifications, including: 1) the air quality conformity report,<sup>2</sup> which includes an itemized listing of transportation improvements that are assumed in the 2015 CLRP and the TIP, and 2) the Version 2.3.57a User's guide,<sup>3</sup> which documents the overall model application process and describes the relationship between specific network files and program steps in the model chain.

The remainder of this chapter provides an overview of the TPB's network development process and its connection with the annual Air Quality Conformity process.

## **1.1 Annual Air Quality Conformity Process**

The primary goal of TPB's network development program is to furnish inputs to the annual Air Quality Conformity Analysis of the CLRP and TIP. The analysis is generally undertaken each year to determine whether or not on-road mobile emissions resulting from the TIP and CLRP are compliant with approved budgets or prevailing standards set by federal law. The analysis includes the formulation of travel demand forecasts and associated mobile source emissions inventories for a set of milestone years. TPB staff collects TIP and CLRP inputs from all TPB member jurisdictions, the three state departments of transportation (DDOT, MDOT and VDOT), WMATA, MTA, VRE, and other local transit service providers on an annual basis.

The 2015 CLRP air quality conformity schedule, shown in Table 1-1, is typical of the procedure that is followed each cycle. The analysis schedule begins with a Call for Projects and disclosure of the Scope of Work and typically ends with the TPB's considered approval of the proposed TIP and CLRP and the Air Quality Determination findings. Federal regulations require extensive interagency consultation and public review throughout the duration of the analysis.

---

<sup>2</sup> *Air Quality Conformity Analysis of the 2015 Constrained Long-Range Plan Amendment and the FY 2015-2020 Transportation Improvement Program for the National Capital Region*, Transportation Planning Board, October 21, 2015), <https://www.mwcog.org/clrp/resources/2015/2015FinalConformityReport-Complete.pdf>

<sup>3</sup> *Ronald Milone et al., User's Guide for the COG/TPB Travel Demand Forecasting Model, Version 2.3.57a, Volume 1 of 2: Main Report and Appendix A (Flowcharts) (Washington, D.C.: Metropolitan Washington Council of Governments, National Capital Region Transportation Planning Board, October 29, 2015), [http://www.mwcog.org/transportation/activities/models/files/V2357a/mwcog\\_travel\\_model\\_v2.3.57a\\_user\\_guide\\_v2\\_with\\_app\\_A.pdf](http://www.mwcog.org/transportation/activities/models/files/V2357a/mwcog_travel_model_v2.3.57a_user_guide_v2_with_app_A.pdf)*



The 2015 CLRP air quality analysis involved six forecast year networks: 2015, 2017, 2020, 2025, 2030 and 2040. The networks reflect the TIP and CLRP project phasing obtained from the state and local agencies.

**Table 1-1 Schedule for the 2015 CLRP and FY2015-2020 TIP**

Year	Month	Event
2014	October	TPB briefed on draft call for projects
	November	TPB Released Final Call for Projects
	December	Draft project Inputs deadline for submission
2015	January	Technical Committee reviewed of draft CLRP / TIP Submissions and AQC scope of work
		CLRP & TIP Project Submissions and Draft Scope of Work released for public comment
		TPB Briefed on CLRP/TIP submissions and AQC scope of work
	February	MWAQC TAC briefed on project submissions and AQC scope of work
		Public Comment Period Ended
		TPB reviewed public comments and asked to approve CLRP / TIP Submissions and draft AQC scope of work
	September	Technical Committee reviewed draft CLRP / TIP and AQC assessment
		Draft CLRP / TIP and conformity assessment released for public comment at Citizens Advisory Committee (CAC)
		TPB Briefed on the draft CLRP/ TIP and conformity assessment
		MWAQC TAC briefed on the draft CLRP / TIP and conformity assessment
	October	Public Comment Period Ended
		TPB reviewed public comments and responses to comments
TPB adopted the draft CLRP / TIP and conformity assessment		

Source: I:\ateam\docum\FY16\2015CLRP\_Network\_Report\NW\_Report\_Tables\ 2015CLRP\_Schedule.xlsx

## 1.2 Network Development Program Overview

Network development activities are carried out in a way that accommodates the air quality conformity determination schedule. The key objective of the network development program is to prepare regional network inputs to the travel model in time for travel modeling work to proceed during the spring. The following procedure is followed each year:

- 1) Pre-existing network inputs developed for the previous year’s air quality study, and the previous TIP and CLRP, are obtained as a starting point for highway network coding. For example, the 2015 CLRP inputs were built from the previously developed 2014 CLRP inputs. The TPB’s link and node network data are currently stored in a multi-year and multi-modal (highway and transit) Personal Geodatabase. TPB staff essentially develops a single multi-year database for each TIP and CLRP.
- 2) The pre-existing highway networks are subject to ongoing review and updates, such as when errors are detected by TPB staff or external users of the regional travel model. These types of updates are incorporated into the current-year TIP and CLRP network database throughout the year.

- 3) The transit network “base year” data is refreshed each year with the latest schedule information provided by the local operators, and provides the starting point for transit coding each year. Most of the transit schedule information is obtained from digital files that now exist in the public domain. The base year data are generally consistent with the fall period of the air quality conformity cycle. For the air quality analysis of the 2015 CLRP, the transit network base year was 2014.
- 4) The current-year TIP and CLRP network elements (both highway and transit) are collected from the state and local implementing agencies and coded into the network. The coded projects are those considered to be “regionally significant”,<sup>4</sup> as defined by the TPB.
- 5) Other miscellaneous and policy-related network inputs that are not currently stored in the geodatabase are prepared for each milestone year.

Network development activities also address the production of networks required for special project planning studies, as well as the development of specialized inputs supporting the TPB’s Models Development activities. This report focuses on the data and conventions used to construct the basic CLRP networks.

### **1.3 Report Structure**

The remainder of this report addresses the structure and conventions of the TPB travel model transportation networks in greater detail. Chapter 2 presents the foundational elements of the TPB’s transportation networks, such as the zonal area system underpinning the network and the components of the regional highway network. Chapter 3 describes the individual network files that are prepared for the transportation model and the attributes that are contained in each file. Chapter 4 describes the database that is currently used to maintain the regional network data. The database has been specially designed to consolidate network-related information within a multi-year and multi-modal framework and in a geographically referenced framework.

---

<sup>4</sup> Memorandum from Jane Posey to TPB Technical Committee, Subject: Defining Regional Significance for Conformity, October 6, 2011

## Chapter 2 TPB Transportation Network Background

This chapter presents background on the travel model transportation networks that are developed each year by TPB staff, including a description of the study area, a review of the zone system that underlies the networks, and the time-of-day period definitions that are represented. The basic elements associated with highway and transit networks are described, along with a review of network location (node) numbering. This chapter also presents an overview of the specific travel costs that are developed in the TPB networks and considered in the regional travel model.

### 2.1 Study Area

A map of the TPB modeled study area is shown in Figure 2-1. The area covers 6,800 square miles and includes 22 of the region's primary jurisdictions spanning the District of Columbia, Northern Virginia, suburban Maryland, and one county in West Virginia.<sup>5</sup> The modeled study area extends well beyond the current TPB member-area, which includes 10 of the 22 primary jurisdictions. The TPB-member portion of the modeled area, also shown in Figure 2-1, is about 3,500 square miles in size or about one half of the modeled study area.

### 2.2 Time of Day Considerations

The travel model requires zonal travel times and costs for both peak and off-peak conditions because congestion levels experienced by different travel markets vary substantially over an average weekday. Thus, the travel model networks developed by TPB staff correspond to either peak or off-peak conditions.

Many of the primary highway facilities in the region operate with varying configurations during peak and off-peak hours of the day. Examples of operational changes include:

- HOV priority lanes/facilities: Freeways with diamond lanes or exclusive lanes that are dedicated to HOVs. Many HOV priority lanes operate in the peak-flow direction during peak periods and revert to general purpose lanes during the off-peak hours;
- Facilities with reverse-direction lanes: Several arterials operate with varying directional lane configurations during the morning and evening time periods in order to better serve the peak-flow direction of traffic. Some facilities operate entirely in one direction during rush periods and revert to two-way configurations during the off-peak; and
- Some facilities do not change in operation during the day, but are available only to special markets, such as autos only or airport-bound trips.

---

<sup>5</sup> The term "jurisdiction" includes both counties (e.g., Arlington County) and major cities (e.g., the City of Alexandria and Washington, D.C.). One of the 22 jurisdictions, Spotsylvania County is only partially included in the modeled study area- the northern portion approximately north of VA 606. All other jurisdictions are fully included in the study area.

Figure 2-1 COG/TPB modeled area – 3,722-zone area system

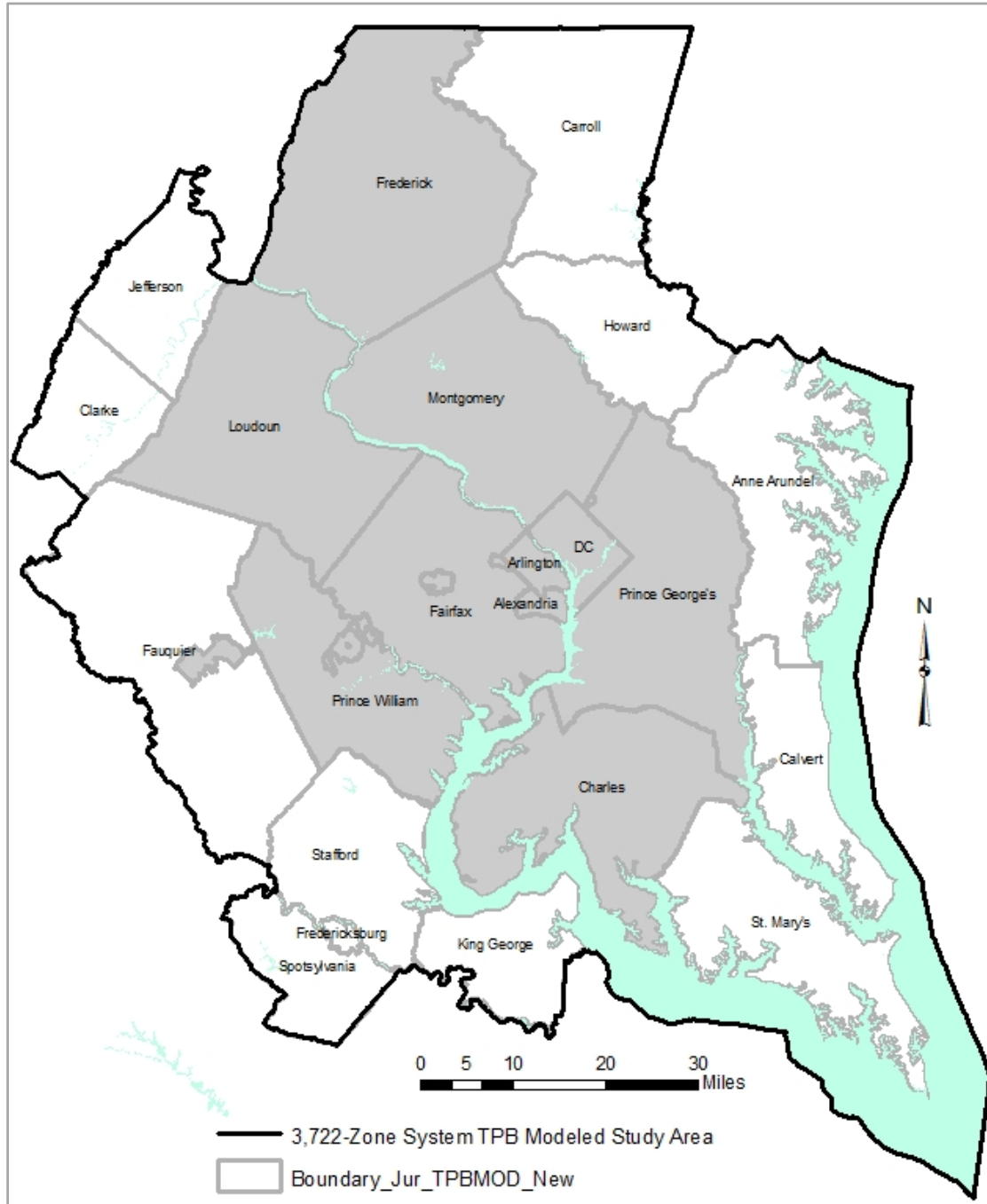

**Note:** The TPB Member area also includes the urbanized portion of Fauquier County.

The following time-period definitions are used for the highway network:

- AM peak period (3 hours: 6:00 AM to 9:00 AM)
- Midday period (6 hours: 9:00 AM to 3:00 PM)
- PM peak period (4 hours: 3:00 PM to 7:00 PM)
- Night/early morning period (11 hours: 7:00 PM to 6:00 AM)

Although traffic assignment is conducted for four time-of-day periods (AM peak period, midday, PM peak period, and nighttime), the trip distribution and mode choice steps operate with travel times and costs developed from the AM peak period and midday period only.<sup>6</sup>

The highway network distinguishes these special operations by using facility-specific attributes that change by time-of-day period. These attributes include directional lanes and codes that enable or disable the use of a specific facility to specific travel markets (e.g., HOV traffic). Highway costs (tolls) on specific facilities are also coded differentially by time-of-day period.

The operational differences reflected in the regional highway networks pertain essentially to high level facilities (freeways and principal arterials). While numerous operational differences between time periods exist on minor arterials and collectors facilities (for example turn prohibitions or parking restrictions), they are not reflected in the TPB networks.

Like the highway network, the level of transit service in the Washington, D.C. region varies substantially during the average weekday. Consequently, transit networks prepared for the travel model provide a representation of peak and off-peak service. For each modeled transit route, an average headway (service frequency) and an average run time (time from start of the route to the end of the route) is calculated for the two time-of-day periods. For the calculation of average headways and run times, the peak period is represented by the AM peak hour (7:00-7:59 AM) and the off-peak period is represented by the five-hour midday period (10:00 AM to 2:59 PM).<sup>7</sup> The AM period definition is reasonably representative of most peak/commuter service, but may not be adequate to represent peak-period service operating in the outer reaches of the region. Consequently, the peak frequencies and running times for express bus and local bus service in some “outer” jurisdictions are developed using an earlier peak hour definition which is decidedly more representative of peak conditions. The specific peak hour selected is based on the professional judgment of the network coder.

## 2.3 Zone Area System

Transportation Analysis Zones (TAZs) represent the basic geographic unit by which regional highway and transit travel flows are estimated by the travel demand model. The TAZ system is important to the overall network design because TAZs delineate the finest level of spatial resolution that can be supported by the land activity inputs, and hence the travel model. Consequently, the highway and transit facilities represented in the regional network are purposefully designed to conform around each TAZ as closely as possible.

The existing modeled area is subdivided into 3,722 TAZs. The zone system includes 3,675 internal TAZs and 47 external stations, which represent points of entry to, and exit from, the modeled area. The 3,722-TAZ system has been in existence since 2009 and has been designed to provide a greater level of resolution in concentrated areas of development known as “activity centers and clusters.” These concentrated areas were identified by COG’s Metropolitan Development Policy Committee in 2007 as a

---

<sup>6</sup> Milone et al., *User’s Guide for the MWCOG/NCRTPB Travel Forecasting Model, Version 2.3.57a*, pg. 119.

<sup>7</sup> *Ibid.*, 133.

basis for encouraging mixed use development and as an aid for improving the coordination of land use and transportation planning.

The 3,722 TAZ system numbering has been developed on a jurisdictional basis as shown in Table 2-1. The table indicates that the internal TAZs are numbered from 1 to 3675. The external station locations are shown in Figure 2-2 and Figure 2-3. External station numbers are sequenced from 3676 to 3722 and are assigned to highway facilities in a clockwise direction, from Virginia Route 3 station in King George County to US 50/301 (the Chesapeake Bay Bridge) in Anne Arundel County. The table also indicates that 1,278 reserved TAZs are currently available for subzone work. However, changes to the existing TAZ system would require changes to dimensions that are currently specified in application scripts and programs.

The TAZs in Table 2-1 are referred to as “TPB TAZ” to distinguish them from “COG TAZ.” In 2008 and 2009, the COG GIS staff developed a new system of TAZs, which had more zones, but did not increase the size of the modeled area. In other words, the new zones were, on average, smaller than the previous zone system, which is useful for better modeling of transit and non-motorized trips. The old zone system had 2,191 TAZs and the new system has 3,722 TAZs. Reviews of the initial 3,722-TAZ system used in the COG Cooperative Forecasting process uncovered some instances where TAZ boundary refinements were needed. The final result was that there are now two sets of zones for the 3,722-TAZ area system:

- COG TAZs: For land activity forecasts (COGTAZ3722\_TPBMOD)
- TPB TAZs: For transportation modeling (TPBTAZ3722\_TPBMOD)<sup>8</sup>

The specific differences between the two area systems are detailed in Table 2-2.

---

<sup>8</sup> Meseret Seifu, “Review of New Zone System: 3722 Transportation Analysis Zones (TAZ)” (presented at the January 22, 2010 meeting of the Travel Forecasting Subcommittee of the Technical Committee of the National Capital Region Transportation Planning Board, held at the Metropolitan Washington Council of Governments, Washington, D.C., January 22, 2010), 23, <http://www.mwcog.org/uploads/committee-documents/Z15aV1dd20100122152445.pdf>.

**Table 2-1 Jurisdictional summary of 3,722 TPB TAZ ranges**

Jurisdiction	Jur. Code	Beginning TAZ No.	Ending TAZ No.	TAZ/Station Count
District of Columbia	0	1	393	393
Montgomery Co., Md.	1	394	769	376
Prince George's Co., Md.	2	770	1404	635
Arlington Co., Va.	3	1405	1545	141
City of Alexandria, Va.	4	1546	1610	65
Fairfax Co., Va.	5	1611	2159	549
Loudoun Co., Va.	6	2160	2441	282
Prince William Co., Va.	7	2442	2819	378
Frederick Co., Md.	9	2820	2949	130
Howard Co., Md.	10	2950	3017	68
Anne Arundel Co., Md.	11	3018	3116	99
Charles Co., Md.	12	3117	3229	113
Carroll Co., Md.	14	3230	3287	58
Calvert Co., Md	15	3288	3334	47
St. Mary's Co., Md.	16	3335	3409	75
King George Co., Va.	17	3410	3434	25
City of Fredericksburg, Va.	18	3435	3448	14
Stafford Co., Va.	19	3449	3541	93
Spotsylvania Co., Va.	20	3542	3603	62
Fauquier Co., Va.	21	3604	3653	50
Clarke Co., Va.	22	3654	3662	9
Jefferson Co., WVa.	23	3663	3675	13
<b>Total Internal TAZs</b>				<b>3,675</b>
<b>External Stations:</b>		<b>3676</b>	<b>3722</b>	<b>47</b>
<b>Reserved TAZ numbers</b>		<b>3723</b>	<b>5000</b>	<b>1,278</b>

Ref: "\\cogfs002\ntp\\$\ateam\docum\fy14\2013CLRP\_Network\_Report\3722taz\_master\_node\_table\_aug\_2013.xlsx"

Note: 13 of the 3675 internal TAZs are unused: 61, 382, 770, 777, 2555, 2629, 3103, 3266, 3267, 3478, 3482, 3495, 3544

**Table 2-2 Differences between COG TAZ and TPB TAZ area systems**

COG TAZ	Jurisdiction	Issue	TPB TAZ
61	District of Columbia	island/water body	unused TAZ
382	District of Columbia	water body	unused TAZ
770	Prince George's Co., MD	water body	unused TAZ
777	Prince George's Co., MD	water body	unused TAZ
2555	Prince William Co., VA	resolution too fine for regional model	dissolved into TAZ 2554
2629	Prince William Co., VA	resolution too fine for regional model	dissolved into TAZ 2630
3103	Anne Arundel Co., MD	resolution too fine for regional model	unused TAZ
3266	Carroll Co., MD	peninsula/water body	unused TAZ
3267	Carroll Co., MD	water body	unused TAZ
3482	Stafford Co., VA	resolution too fine for regional model	dissolved into TAZ 3489
3478	Stafford Co., VA	resolution too fine for regional model	dissolved into TAZ 3489
3495	Stafford Co., VA	resolution too fine for regional model	dissolved into TAZ 3494
3544	Spotsylvania Co., VA	water body	unused TAZ

Figure 2-2 Location of external stations in the modeled area

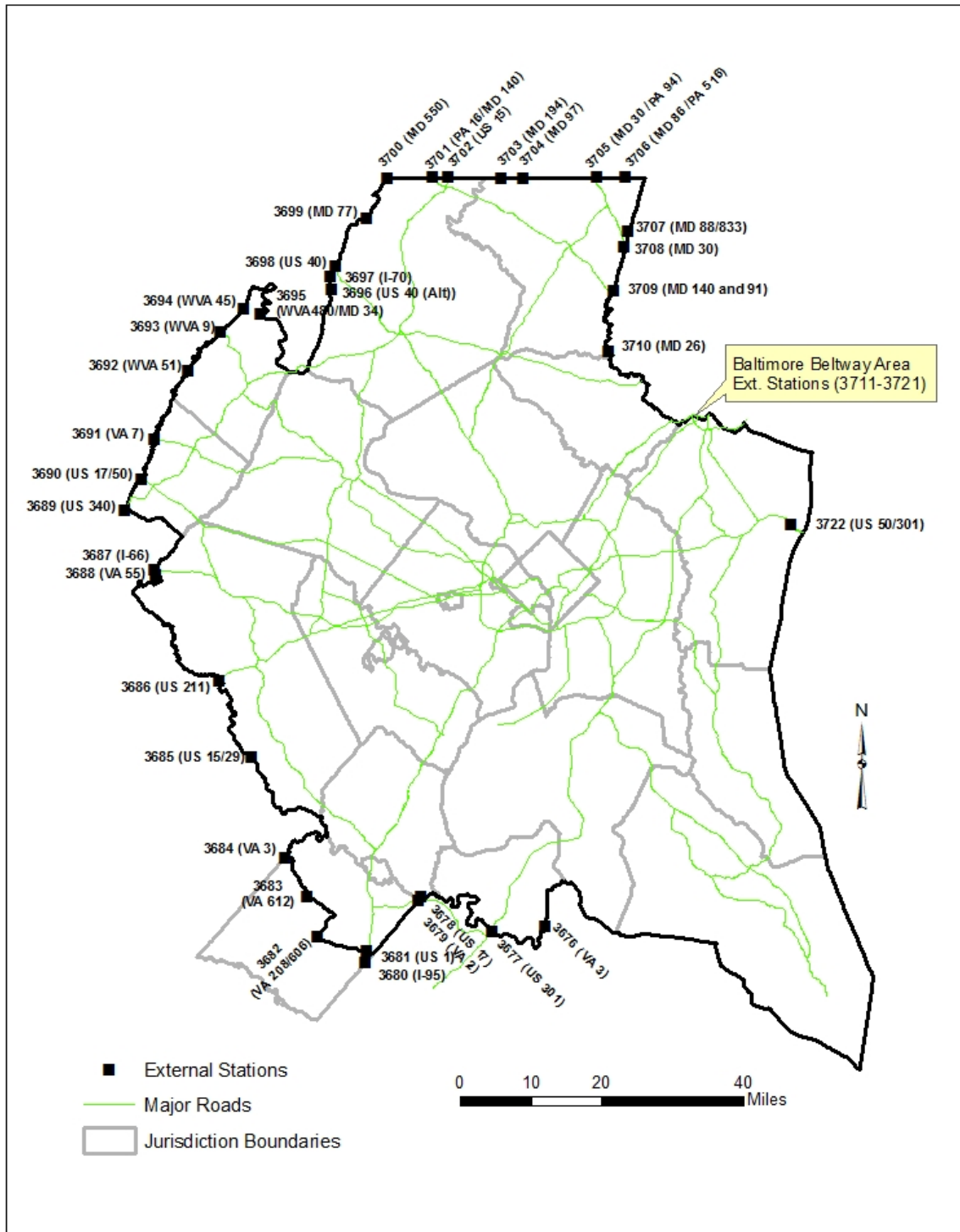
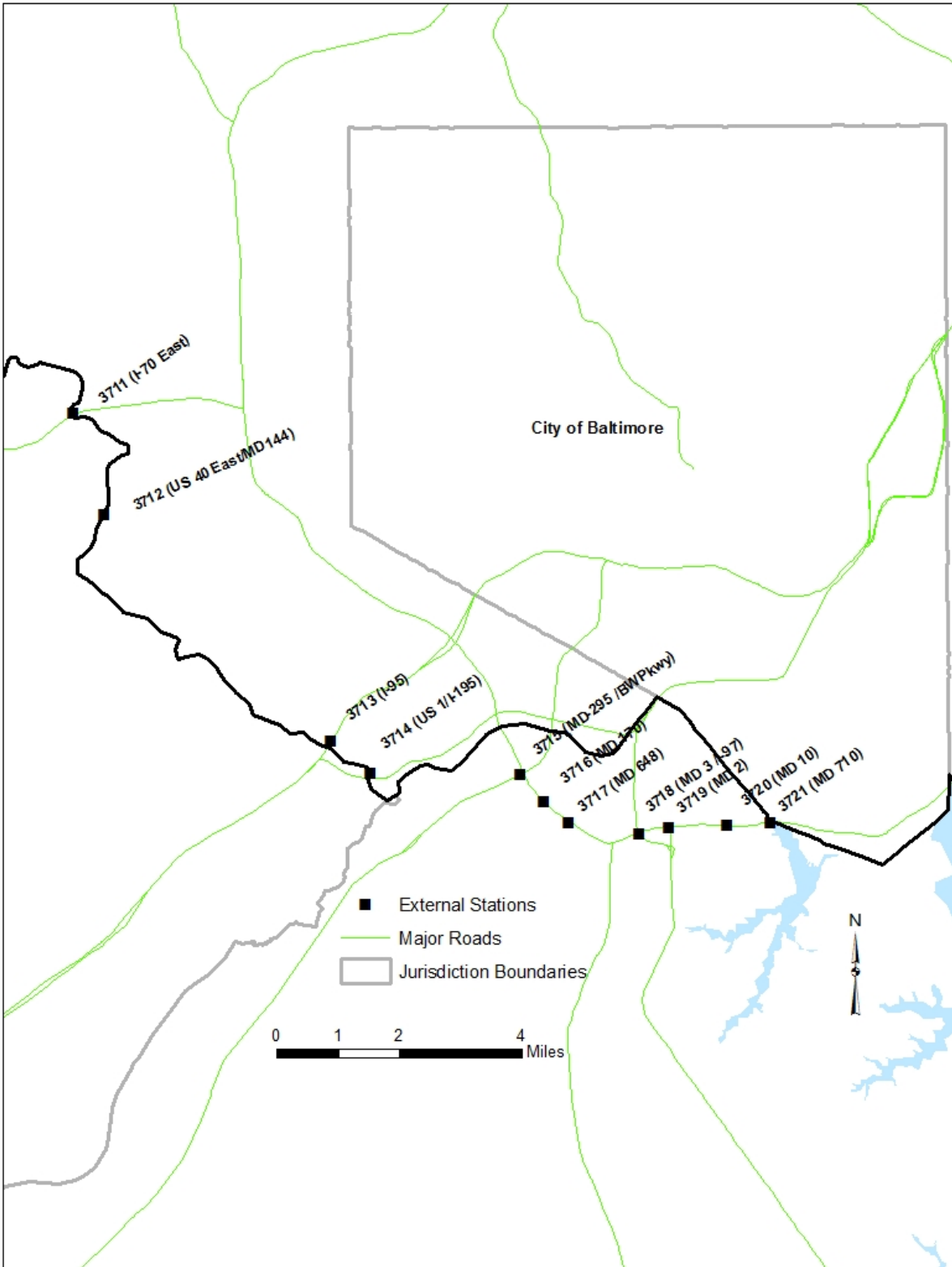



Figure 2-3 Location of external stations in Baltimore Beltway area



Ref: "I:\ateam\docum\fy14\2013CLRP\_Network\_Report\Ext\_Sta\_Balt\_Feb12.jpg"

## 2.4 Highway Network Elements

The transportation networks used by the travel model represent the region's transportation system as a collection of point locations (zone centroids and nodes) and transportation facility segments (links). This relatively simplistic depiction of the system provides the travel model with concise information about roadway connectivity and capacity that exists between zones. The model evaluates demand against the network capacity and subsequently produces level-of-service metrics (times and costs) between zones, which are important variables in the model.

There are several types of nodes and links that are used in the highway networks. These types are listed and described below:

- **Zone Centroids:** Point locations which represent the geographic center of activity of a TAZ. All trips begin and end at zone centroids. Although zones also have boundaries, zone boundaries are not explicitly represented in the transportation network, so all trips travel from one zone centroid to another zone centroid. The travel model represents zone-to-zone travel (inter-zonal travel), but not within-zone travel (intra-zonal travel), since this is below the grain of the model and its associated network.
- **PNR "Dummy" Centroids:** Point locations which represent park-and-ride (PNR) parking lots at Metrorail and commuter rail stations. These are components of the highway network that exist so that congested travel times from TAZs to rail PNR lots may be developed in the construction of auto-access links in the transit network.
- **Highway Nodes:** Point locations that represent highway intersections, zonal points-of-access to the highway system, or simply "break points" or "shape points" for links representing highway facilities.
- **Centroid Connector Links:** Segments (or links) between zone centroids and the highway network by which generated traffic may leave or enter the TAZ. These special links represent the physical connection between zonal activity and the highway system based on the underlying localized street system. Centroid connections usually number from one to four links for each TAZ. Traffic "loaded" on centroid connectors is exclusively limited to trips originating or destined to a specific TAZ.
- **PNR Connector Links:** Segments that represent access links between Metrorail/commuter rail PNR lots and the highway network. Traffic is not "loaded" on these types of links; they are used for the sole purpose of developing congested TAZ-to-PNR travel times.
- **Highway Links:** These represent the major highway segments in the regional network on which regional traffic is "loaded." The segments are comprised of freeway, expressway, arterial, and collector facilities and do not include local streets. Freeway links are usually coded by direction, as two "one-way" links. In contrast, most non-freeway segments are represented as a single "two-way" facility. Freeway ramps are included in the regional network, but are not represented as a "cloverleaf." Instead ramps are coarsely represented, and the regional model does not furnish accurate ramp volumes.

- **“Transit Only” Links:** This is a special group of highway links that exist below the zone level of analysis. These links exist in the network to improve the detail of bus route coding with respect to zonal access to transit, particularly in areas where the zone size is large. These links are excluded from the traffic assignment process; regional traffic is not “loaded” onto this class of links.

## 2.5 Transit Network Elements

The transit system contains some components of the highway system described above, and also consists of additional “point” and “segment” elements that are necessary for transit path building. The TPB transit network consists of a combination of the highway network along with transit-related elements. The transit elements are listed and described below:

- **Rail Stations:** Point locations where travelers may board or alight from fixed guideway transit service, including Metrorail, commuter rail, light rail, street car, and BRT.
- **Transit PNR Lots:** Park-and-Ride lot “point” locations. It is assumed that “auto-access” trips originating from TAZ centroids park at these locations, prior to boarding at rail stations or at bus stops (most typically express bus stops). The model also considers Kiss-and-Ride access but those do not connect to PNR lots; they connect directly to the rail stations.
- **Rail Links:** These represent fixed guideway (Metrorail, commuter rail, light rail, streetcar and BRT) segments that connect rail stations. These are not part of the background highway network.
- **PNR Lot-to-Station Walking Links:** Links representing sidewalks between the PNR lot and the rail station.
- **Bus-to-Station Transfer Links:** Links representing sidewalks between bus stops and rail stations.
- **Walk Access Links:** Walk connections between zone centroids and transit stops accessible from the TAZ.
- **Auto Access Links:** Auto connections between the zone centroid and proximate PNR lots.
- **Sidewalk Links:** All highway links, other than freeways and expressways that are available for accessing transit from a zone centroid, or are available for transferring between transit modes.
- **Transit lines:** These are the individual transit routes that are in service during specific time periods. Transit lines are categorized among “modes” which distinguish basic service types (including, for example, Metrorail lines). The “line” files contain general characteristics (mode, average headway, route end-to-end running time, and a one- or two-way indicator) as well as the route delineation, which is expressed as a node string. The route delineation of bus-related modes is defined as a series of highway nodes. Rail related route delineation is defined as a series of station nodes.

Most of the highway and transit network inputs are files that contain attributes of elements listed above. The attributes describe the physical location of nodes and the physical characteristics of links, such as the number of lanes, distance and the facility classification. These are specified in Chapter 3.

## 2.6 Overview of Network Travel Costs

The Version 2.3.57a Travel Model requires several traveler out-of-pocket cost inputs. Most of the traveler costs are network-related or path-related elements. All of the cost inputs are either prepared in constant-year (2007) dollars or are converted to constant-year dollars as part of the model application process. The year 2007 is the model “base-year” because that was the year when model calibration data was collected. The travel model currently considers five travel cost components each affecting different varying steps of the travel model:

- Transit related
  - Transit fares
  - Parking costs associated with drive-access to transit (parking at a PNR lot)
- Highway related
  - Highway tolls
  - Parking costs associated with a non-transit trip
  - Other auto operating costs (distance based)

Transit fares are computed within the model stream in terms of current-year dollars, and are ultimately converted to constant-year dollars. PNR-related parking costs are provided for both peak and off peak period. These PNR parking costs are stored in the station file (station.dbf). Highway tolls are obtained from the appropriate websites. Both PNR parking costs and tolls are coded as input variables in current-year dollars. Parking costs associated with a non-transit trip are calculated using a parking cost model, which is applied with the Cube Voyager script `prefarv23.s`. These parking costs are a function of job density, specifically attraction TAZ employment density. This script also calculates “terminal time,” i.e., the time to park and un-park a car.<sup>9</sup> Since these parking costs are calculated with a parking cost model, the network coder does not have to collect these. Lastly, auto operating costs are computed directly in year-2007 dollars on the basis of a single per-mile parameter.

Highway tolls are coded on a highway network on a link-by-link basis and are specified as either a flat cost or as a per-mile rate. Highway tolls are rather unique cost components in that they affect the construction of highway paths. Most conventional travel models build minimum impedance paths on the basis of congested travel time. The TPB model builds highway paths on the basis of a generalized cost function that equals the congested travel time plus the travel time equivalent of tolled costs. The monetary toll between zones therefore reflects any toll segments that exist along each minimum generalized cost path.

PNR lot costs are coded as a station node attribute in the network input files in current-year cents. PNR lot costs, like tolls, are used exclusively in the development of rail-related transit paths. PNR lot costs may be altered with “shadow-price” variables that also exist in the station file for the purpose of calibrating auto access demand at specific rail stations. Also, unlike the other cost components, the PNR lot cost is not considered in the mode choice modeling process.

---

<sup>9</sup> See p. 154 of Milone et al., *User’s Guide for the MWCOC/NCRTPB Travel Forecasting Model, Version 2.3, Build 57a*.

Zone-to-zone transit fares are computed in a way that mimics WMATA’s actual fare policy. The computation involves two steps: 1) the calculation of Metrorail fares between stations using WMATA policy parameters and 2) combining Metrorail fares between stations with bus/commuter rail fares between “Bus Fare Zones” which are entered as an input. Bus Fare Zones are currently 21 “macro areas” of the region that approximate WMATA policy areas and other transit market areas. The transit fares are dependent on minimum perceived time paths between TAZ that include Metrorail defined boarding and alighting stations, if Metrorail use is included within the path.

## 2.7 Node Numbering System

The various node groups are numbered in the network in a fairly structured way. Structured node numbering is useful because it facilitates network integrity checks and network mapping. It is also important because model application programs reference predefined TAZs and node numbers and node ranges for the purposes of indexing or dimensioning.

An overview of the node numbering system that has been adopted for highway and transit networks on the 3,722-TAZ system is shown in Table 2-3. The numbering system allocates nodes from lowest to highest beginning with TAZs, station centroids, station nodes, PNR lot nodes, and finally highway nodes.

**Table 2-3 TAZ/node numbering system overview**

Node Class	Node Type	Beginning TAZ / Node	Ending TAZ / Node	Node Count
<b>TAZ/PNR Centroids</b>	Internal TAZ Centroid	1	3675	3,675
	External Stations:	3676	3722	47
	Reserved TAZ numbers	3723	5000	1,278
	PNR Centroid	5001	7999	2,999
<b>Transit Nodes</b>	Transit Station Nodes	8000	10999	3,000
	Transit PNR Lot Nodes	11000	13999	3,000
	Transit Reserved Nodes	14000	19999	6,000
<b>Highway Network Nodes</b>		20000	54999	35,000

Ref: " I:\ateam\docum\FY15\2014CLRP\_Network\_Report\NW\_Report\_Tables\3722TAZ\_Master\_Node\_Table\_Jan\_2015.xlsx"

The sub-allocation of transit nodes above are further detailed in Table 2-4.

**Table 2-4 Node numbering system for transit nodes**

<b>Node Type</b>	<b>Beginning TAZ / Node</b>	<b>Ending TAZ / Node</b>	<b>TAZ / Node Count</b>
Metrorail PNR Centroids:	5000	5999	1000
Commuter Rail PNR Centroids:	6000	6999	1000
Light Rail/BRT PNR Centroids:	7000	7999	1000
Metrorail Station Node:	8000	8999	1000
Commuter Rail Station Node:	9000	9999	1000
Light Rail Station Node:	10000	10499	500
BRT Street car Station Node:	10500	10999	500
Metrorail PNR Lot Node:	11000	11999	1000
Commuter PNR Lot Node:	12000	12999	1000
Bus PNR Lot Node:	13000	13999	1000
Reserved Transit Nodes	14000	19999	6000

Ref: "I:\ateam\docum\FY16\2015CLRP\_Network\_Report\NW\_Report\_Tables\3722TAZ\_Master\_Node\_Table\_Jan\_2015.xlsx"

Note: 7000-7999 range is not currently used in the geodatabase.

Highway node numbers are allocated in discrete ranges by jurisdiction, as shown in Table 2-5.

**Table 2-5 Allocated highway node ranges by jurisdiction**

<b>Jurisdiction</b>	<b>Beginning TAZ / Node</b>	<b>Ending TAZ / Node</b>	<b>Allocated Nodes</b>
District of Columbia	20000	21999	2000
Montgomery Co., Md.	22000	25999	4000
Prince George's Co., Md.	26000	29999	4000
Arlington Co., Va.	30000	31999	2000
City of Alexandria, Va.	32000	33999	2000
Fairfax Co., Va.	34000	37999	4000
Loudoun Co., Va.	38000	39999	2000
Prince William Co., Va.	40000	41999	2000
Frederick Co., Md.	42000	43999	2000
Howard Co., Md.	44000	45499	1500
Anne Arundel Co., Md.	45500	46999	1500
Charles Co., Md.	47000	47999	1000
Carroll Co., Md.	48000	48999	1000
Calvert Co., Md	49000	49499	500
St. Mary's Co., Md.	49500	49999	500
King George Co., Va.	50000	50499	500
City of Fredericksburg, Va.	50500	50999	500
Stafford Co., Va.	51000	51999	1000
Spotsylvania Co., Va.	52000	52999	1000
Fauquier Co., Va.	53000	53999	1000
Clarke Co., Va.	54000	54499	500
Jefferson Co., WV.	54500	54999	500

## Chapter 3 Cube Voyager Network Inputs

Chapter 2 provided a broad overview of the TPB transportation networks in terms of the TAZ system, network elements, and node numbering conventions. This chapter presents more detail on the specific input files that are prepared, which include policy-related inputs as well as infrastructure-related inputs. The input files are presented in four sub-sections: cost deflation inputs, highway network inputs, transit network inputs, and transit fare inputs.

It is important to note that all of the input filenames used by the TPB travel demand model are assigned generic names, such as “link.dbf.” The application approach of the Version 2.3.57a travel model distinguishes modeled scenarios using scenario-specific *subdirectories*, each containing generic input *filenames*. While this approach might appear confusing and error-prone, TPB staff has grown comfortable with the application approach for several years. More detail on the TPB’s model application may be found in the User’s Guide.<sup>10</sup>

### 3.1 Cost Deflation Inputs

The Version 2.3.57a model application includes a procedure that creates an inflation/deflation factor for converting current-year costs into constant-year (year-2007) costs. The factor is used in subsequent steps and applied to highway tolls and transit fares. The cost deflation factor information is stored in a user-prepared parameter file, shown in Figure 3-1. The file contains the historical year-to-year consumer price index (CPI) schedule published by the Bureau of Labor Statistics (BLS). The specific CPI index definition used for deflating modeled transportation costs is defined as “All Urban Consumers/U.S. city average for all items (1982-84=100).” The following link was used to obtain historical CPI data:

<http://www.bls.gov/cpi/cpid1501.pdf>

The CPI parameter file (Figure 3-1) is updated each year. The file contains a table showing the annual CPI starting from 2007 to the most recent historical year. The table also includes the computed average annual growth rate and the deflation factor implied from the base year to the current year. The deflation rate for converting current year costs is based on the historical rate of inflation defined as the base-year CPI divided by current-year CPI (the most recent year for which annual CPI data is furnished). As shown in the above parameter file, the existing deflation factor for the current year (2014) is 0.87584 (or 207.3 divided by 237.0). The ratio implies an average historical annual inflation rate between 2007 and 2014 is 1.92%. The historical and projected CPI growth at 2% is shown as a solid line in Figure 3-2. TPB travel forecasts generally assume that future cost escalation will follow the historical rate of inflation.

The InflationFTR variable (“inflation/deflation factor” variable) enables one to investigate varying future cost escalation scenarios. An InflationFTR value of “1.0” implies that future costs will escalate directly with the historical CPI growth rate. The parameter may be changed to, for example, “0.5” to reflect cost growth at one-half of the historical growth rate or to “2.0” to reflect cost growth at twice the historical

---

<sup>10</sup> User’s Guide for the MWCOC/NCRTPB Travel Forecasting Model, Version 2.3, Build 57a, 10/29/15, Pg.33

growth rate, etc. The dashed lines in Figure 3-2 indicate how project cost escalation for these types of scenarios compare with the TPB's default cost escalation assumption.

**Figure 3-1 Cost deflation parameter file (CPI\_File.txt)**

```

;; - MWCOG V2.3 Travel Model - Cost deflation Table
;; - 3/5/2014 - CPI data from BLS / All Urban Consumers (CPI-U) US City Avg.1982-84=100.0
;; http://www.bls.gov/cpi/cpid1501.pdf (Reference Table 29.)

InflationFTR      = 1.0    ; Inflation Assumption (DEFAULT IS 1.0)
Defl_OverRide    = 0.0    ; Deflation Override (DEFAULT IS 0.0) If Non-zero it is used as
deflator
                                ; Used as deflator IF NON-ZERO
BaseCPIYear      = 2007   ; Base year of the CPI Table
CurrCPIYear      = 2014   ; Current year on CPI table below (Year for which complete annual
CPI data is available)
;
;=====
; Establish historic CPI table and Deflation Factor =
;=====
;
LOOKUP Name=CPI_Table,
LOOKUP[1] = 1,Result = 2,          ;; CPI index (from US BLS)
LOOKUP[2] = 1,Result = 3,          ;; Compounded Growth Rate From Base Year
LOOKUP[3] = 1,Result = 4,          ;; Deflation Factor
Interpolate = N, FAIL=0,0,0,list=Y,
;;
;;          (((YrCPI/BsCPI)^(1/n))-1.0)*100   BsCPI/YrCPI)
;;          Annual_Avg.                        Historic Deflation
;; YEAR      CPI                               Growth_Rate(%)      Factor
;; -----
R=' 2007, 207.342, 0.000, 1.000 ', ; <--- BaseCPIYear
' 2008, 215.303, 3.861, 0.963 ', ;
' 2009, 214.537, 1.731, 0.966 ', ;
' 2010, 218.056, 1.700, 0.951 ', ;
' 2011, 224.939, 2.063, 0.922 ', ;
' 2012, 229.594, 2.064, 0.903 ', ;
' 2013, 232.957, 1.964, 0.890 ', ;
' 2014, 236.736, 1.915, 0.876 ' ; <--- Curr(ent)CPI Year
; --- end of CPI File -----
; -----

```



**Figure 3-2 Projected CPI escalation at varying annual growth rates**

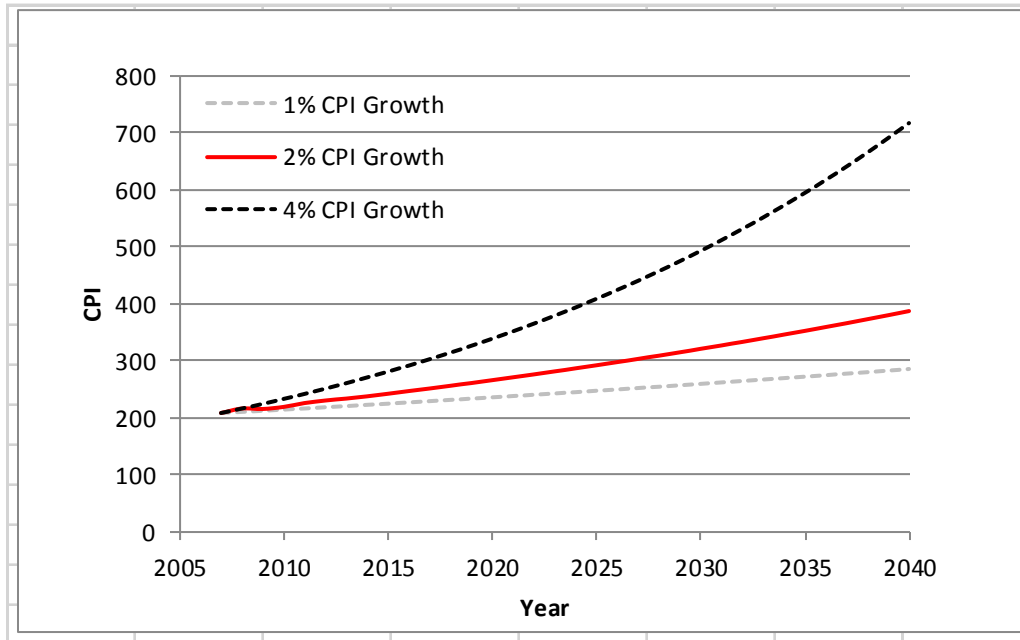

Ref: "I:\ateam\docum\FY16\2015CLRP\_Network\_Report\NW\_Report\_Tables\cpi.xlsx"

The CPI\_File.txt file is called into the SET\_CPI.S script as shown in Figure 3-3. The script writes out two one-line text files containing the deflation factors that are used to convert current year highway and transit costs to constant-year costs in subsequent modeling steps. The MFARE2\_CPI.txt file contains summary CPI information.

**Figure 3-3 Deflation process in the Version 2.3 Travel Model**

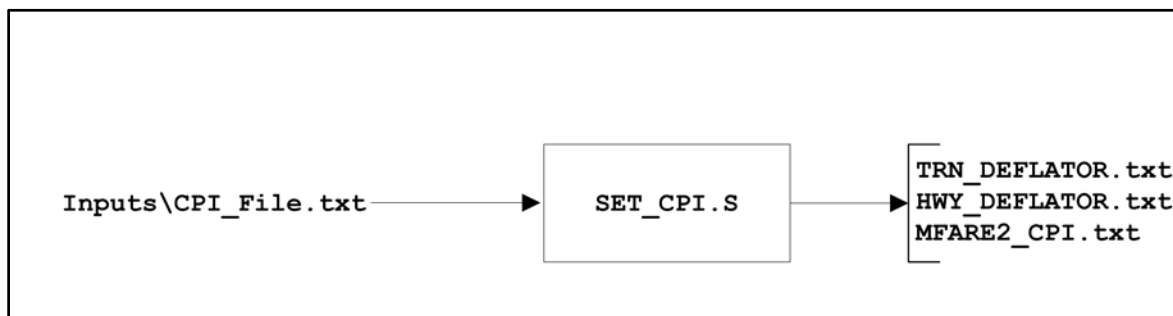

### 3.2 Highway Network Files

A list of user-generated highway network inputs is provided in Table 3-1. The list includes a node file, a link file, a zonal land activity file, and a toll parameter file. The files are read into Cube Voyager scripts and are ultimately converted into a single binary or “built” network file. Binary networks are used in the travel model application because they enable the software to process network-related operations more

efficiently. The binary network ultimately created from the TPB “building” process is named *zonehwy.net*. This file is sometimes referred to as an “unloaded network” file because it does not include link volumes resulting from the traffic assignment step.

Table 3-1 also indicates the source of the files. The highway node and link file are developed from a multi-year and multi-modal geodatabase that is discussed in Chapter 4. Other inputs relating to zonal land activity and policy parameters are generated either manually or by off-line procedures.

**Table 3-1 Listing of highway network input files**

Filename	Description	Type	Source
Node.dbf	XY coordinates of nodes in highway network	DBF	Geodatabase
Zone.dbf	Land use/land activity data at zonal level, 3722 TAZ	DBF	Analyst-generated
Link.dbf	Highway network links	DBF	Geodatabase
Toll_Esc.dbf	Toll policy parameters by link "Tollgrp" code	DBF	Analyst-generated

Ref: "I:\ateam\docum\fy14\2013CLRP\_Network\_Report\v23\_inputs\_v10.xlsx"

The above files are used in a network building process that is shown in Figure 3-4. The process involves two steps, one that develops zonal area types (AreaType\_File.S) and another that “builds” the highway network (V2.3\_Highway\_Build.S). The inputs files and the two steps are described in the next sections of the report.

**Figure 3-4 Highway network construction process**

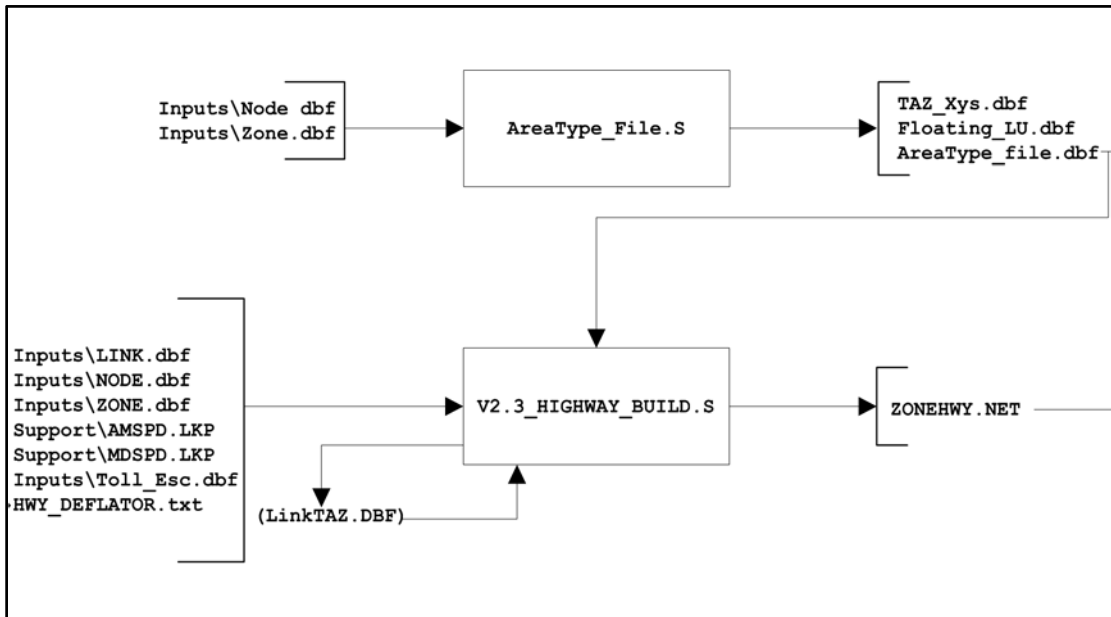

### 3.2.1 Zonal land use

The zone.dbf file contains zonal land activity and other items that are shown in Table 3-2. This file is created from a standard Cube Voyager process that reads a single, standardized, multi-year file from COG’s Cooperative Forecasts of land activity, and creates individual (year-by-year) files, that are used by the travel model. The Round 8.4 land activity was employed in the 2015 CLRP conformity. The Round 8.4 land activity totals for the modeled region are shown in Table 3-3. Cooperative Forecasts are prepared in five-year increments. If intermediate years are modeled, such as 2017 in the 2015 CLRP analysis, the land activity values are linearly interpolated.

**Table 3-2 Format description of the land use file (zone.dbf)**

File Name	Variable Name	Description
Zone.dbf	TAZ	TAZ (1-3,722)
	HH	Households
	HHPOP	Household Population
	GQPOP	Group Quarters Population
	TOTPOP	Total Population
	TOTEMP	Total Employment
	INDEMP	Industrial Employment
	RETEMP	Retail Employment
	OFFEMP	Office Employment
	OTHEMP	Other Employment
	JURCODE	Jurisdiction Code (0-23) <i>0/dc, 1/mtg, 2/pg, 3/alr/, 4/alx,5, ffx, 6/ldn, 7/ pw, 8/(unused), 9/frd, 10/how, 11/aa, 12/chs, 13/(unused), 14/car, 15/cal, 16/stm, 17/ kg, 18/fbg, 19/stf, 20/spts, 21/fau, 22/clk, 23/jef</i>
	LANDAREA	Gross Land Area (in sq. miles)
	HHINCIDX	Ratio of zonal HH median income to regional median HH income in tenths (i.e. 10 = 1.0), per 2000 CTPP.
	ADISTTOX	Airline distance to the nearest external station in whole miles.
	TAZXCRD	TAZ X-Coordinates (NAD83-based in whole feet)
TAZYCRD	TAZ Y-Coordinates (NAD83-based in whole feet)	

Before the zone-level land activity data can be used as an input to the travel model, it must undergo an adjustment process, known as the CTPP-based employment adjustment, which ensures that a consistent employment definition is used by all counties and jurisdictions in the modeled area. The reason for this adjustment is that different jurisdictions in the modeled area, which covers DC, Maryland, Virginia, and one county in West Virginia, use different definitions of employment.<sup>11</sup>

<sup>11</sup> For further details, see p. 13 of Milone et al., *User’s Guide for the MWCOG/NCRTPB Travel Forecasting Model, Version 2.3, Build 57a*.

**Table 3-3 Round 8.4 Cooperative Forecasts regional totals by year**

Year	HH	HHPOP	GQPop	TotPop	TotEMP
2010	2,466,227	6,514,567	125,788	6,640,355	3,888,059
2015	2,632,300	6,910,868	136,807	7,047,675	4,095,480
2020	2,807,126	7,331,949	143,058	7,475,007	4,397,669
2025	2,970,445	7,714,946	149,132	7,864,078	4,695,189
2030	3,116,950	8,051,136	153,259	8,204,395	4,987,952
2035	3,245,504	8,347,491	156,658	8,504,149	5,235,937
2040	3,357,575	8,598,702	161,495	8,760,197	5,504,157

**Note:** CTPP employment adjustments have been made

Source: I:\ateam\mod\_inputs\lu\rnd84\_taz3722\Processing\rd84\_tpb3722\_processing.xlsx

### 3.2.2 Highway Link and Node Coordinate Files

The link.dbf file contains the attributes of individual highway segments (links) that comprise the highway network. The link attributes are shown in Table 3-4. The highway network node file, node.dbf (Table 3-5), contains the XY coordinates for both TAZs and highway nodes. The link.dbf file describes basic characteristics of individual highway segments including distance, the number of directional lanes by time period (??LANE), directional user-market enable or disable codes (??LIMIT), and facility type (FTYPE). These highway network link key attributes are described in this section.

**Table 3-4 Base highway link file description (link.dbf)**

File Name	Variable Name	Description
Link.dbf	A	A-Node
	B	B_Node
	DISTANCE	Link distance (in whole miles w/explicit decimal)
	JUR	Jurisdiction Code (0-23) <i>0/dc, 1/mtg, 2/pg, 3/alr/, 4/alx,5, ffx, 6/ldn, 7/ pw, 8/(unused), 9/ frd, 10/how, 11/aa, 12/chs, 13/(unused), 14/car, 15/cal, 16/stm, 17/ kg, 18/fbg, 19/stf, 20/spts, 21/fau, 22/clk, 23/jef</i>
	SCREEN	Screenline Code
	FTYPE	Link Facility Type Code (0-6) <i>0/centroids, 1/Freeways, 2/Major Art., 3/Minor Art, 4/ Collector, 5/ Expressway, 6/ Ramp</i>
	TOLL	Toll Value in current year dollars
	TOLLGRP	Toll Group Code
	AMLANE	AM Peak No. of Lanes
	AMLIMIT	AM Peak Limit Code (0-9)
	PMLANE	PM Peak No. of Lanes
	PMLIMIT	PM Peak Limit Code (0-9)
	OPLANE	Off-Peak No. of Lanes
	OPLIMIT	Off-Peak Limit Code (0-9)
	EDGEID	Geometry network link identifier
	LINKID	Logical network link identifier
	NETYEAR	Planning year of network link
	SHAPE_LENGT	Geometry length of network link (in feet)
	PROJECTID	Project identifier

**Table 3-5 : Highway node file description**

File Name	Variable Name	Description
Node.dbf	N	Highway Node Number
	X	X - Coordinates (NAD83-based in whole feet)
	Y	Y- Coordinates (NAD83-based in whole feet)

Road attributes that may vary by time of day are represented by two sets of link attributes named <prd>lane and <prd>limit, where <prd> is “AM”, “PM”, and “OP.” The lane attribute describes the number of effective through lanes in operation during the period. The limit attribute assigns special market prohibitions that exist during a given time period. The limit prohibitions indicate 1) whether the directional link is available to traffic during the period or 2) whether link is available to certain markets during specific time periods or during the entire day. In many cases, lane coding is related to limit coding. The limit codes currently used by the model are presented in Table 3-6.

**Table 3-6: Limit codes**

Limit Code	Vehicles Allowed	Vehicles Disallowed
0	All Vehicles	No Vehicles
2	HOV 2+ Occ. Vehicles	1-Occ. Vehicles, Trucks
3	HOV 3+ Occ. Vehicles	1, 2 Occ. Vehicles, Trucks
4	All Vehicles, other than trucks	Trucks
5	Airport Passenger Auto Driver Trips	All other Vehicles
9	Transit Only	All other Vehicles

Limit and lane codes are used to reflect changes in directional-lane configurations, a variety of HOV operations, and truck prohibitions (primarily on parkways). Limit coding is also used to identify “Transit Only” links (limit code = 9), which are used to more accurately depict transit route coding relative to zone centroids. These types of links are excluded from the highway assignment process because they are below the grain of both the zone system and the roadways included in the networks.

### 3.2.3 Roadway functional classification and the facility-type variable

Roads/highways are typically classified into a hierarchical system that indicates their design and the type of traffic they are designed to serve. The classic hierarchy is

- Freeways
- Arterials
- Collectors
- Local roads

Higher level roads, such as freeways, have an emphasis on mobility and traffic movement. Lower level roads, such as collectors and local roads, have an emphasis on land access. This continuum is shown graphically in Figure 3-5.

Figure 3-5 Classification of roads and their emphasis on mobility and access

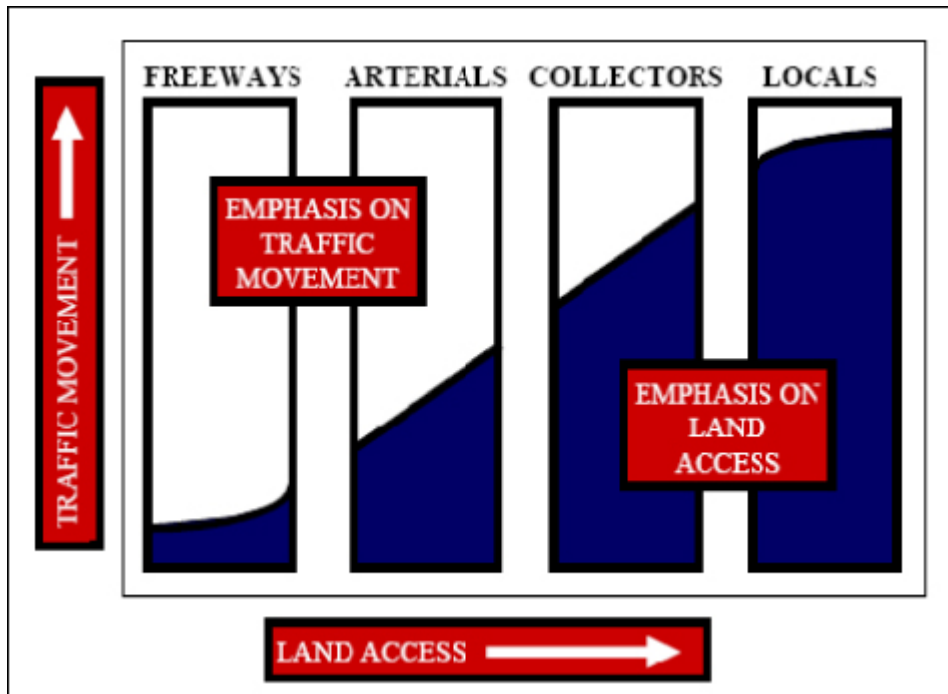

Source: <sup>12</sup>

Figure 3-6 shows examples of the different types of roads.

In COG/TPB highway networks, the facility-type (FTYPE) code is used to designate the hierarchy of road types. Facility-type codes are defined as:

- 0/centroid connectors;
- 1/freeways;
- 2/major arterials;
- 3/minor arterials;
- 4/collectors;
- 5/expressways; and
- 6/freeway and expressway ramps

The highest-class roads in TPB networks are freeways (FTYPE=1) and expressways (FTYPE=5). The lowest-class roads in TPB networks are collectors (FTYPE=4). Note that local roads are not typically part of TPB networks, but each centroid connector represents one or more local roads that are not explicitly represented.

<sup>12</sup> BLF Marketing, Wilbur Smith Associates, Inc., and RKG Associates, Inc., *Clarksville SMART GROWTH Plan – 2030: A Blueprint for Progress and Quality ... as We Grow to 250,000 Residents* (Clarksville, Tennessee, July 23, 2010), chap. 3, <http://www.clarksvillesmartgrowth.com/Sec3-TransportationAnalysis.htm>.

**Figure 3-6 Example of different types of roads**

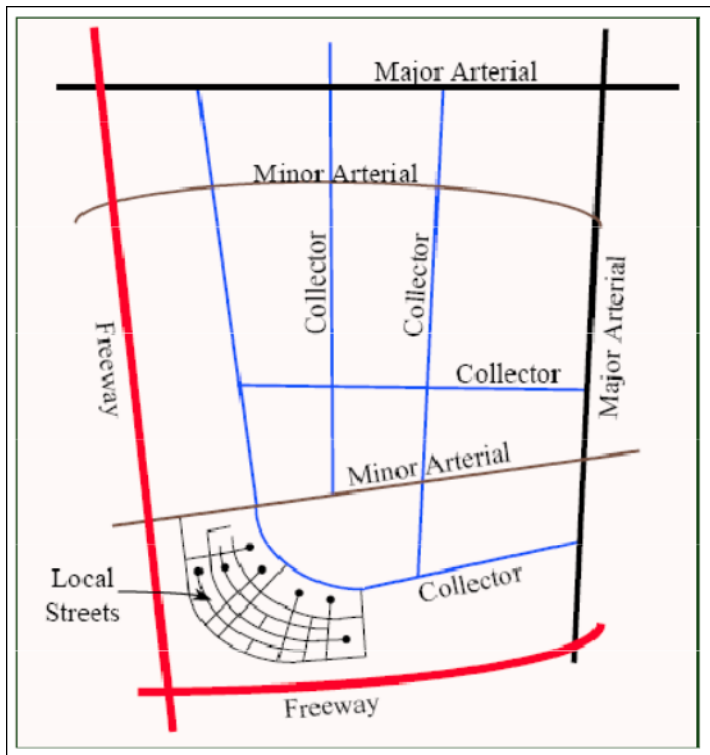

Source: <sup>13</sup>

The facility type (FTYPE) attribute is used in conjunction with an area-type indicator (ATYPE) which is used to establish modeled free-flow speeds and hourly capacity.

The federal government has its own classification scheme, called the federal functional classification system.<sup>14</sup> While there is a correlation between TPB facility-type codes and the federal functional classification system, there are numerous exceptions. For example, facilities categorized as freeways in the federal system may be coded as expressways in the TPB network, or expressways in the federal system may be coded as freeways. These types of classification adjustments are ultimately made to ensure that the facility use and operation is accurately represented in the travel model. It should also be noted that the “ramp code” (FTYPE=6) was added to the facility code list in FY 2003 so that ramp-related VMT and emissions could be summarized from the travel model at the regional level. Ramp-type facilities in the TPB networks are associated with the same speed and capacity characteristics as freeway and expressway facilities.

### 3.2.4 Other link attributes

Modeled link free-flow speeds and capacities are based on the facility type and an area type (ATYPE) variable. The area type identifies, in broad terms, the level of land development around each highway

<sup>13</sup> Ibid.

<sup>14</sup> *Highway Functional Classification Concepts, Criteria and Procedures* (Washington, D.C.: U.S. Department of Transportation, Federal Highway Administration, 2013), [http://www.fhwa.dot.gov/planning/processes/statewide/related/highway\\_functional\\_classifications/fcauab.pdf](http://www.fhwa.dot.gov/planning/processes/statewide/related/highway_functional_classifications/fcauab.pdf).

link. The area type variable is not included in the link.dbf file, but rather, is dynamically generated during the highway network building process:

- In the AreaType\_File.s script, a “1-mile floating” land use density is computed for each TAZ. The floating density for a given TAZ equals the accumulated land activity of the TAZ, plus the land activity of all proximate TAZs within a one-mile radius, divided by the similarly accumulated land area. Floating population and floating employment figures are computed for each TAZ. The one mile radius is evaluated based strictly on centroid positioning;
- Each TAZ is assigned an area type (integer) value of 1 to 6 based on the joint population and employment density ranges defined in Table 3-7;
- The mid-point of each highway link is evaluated against all TAZ centroid positions. Each link is then assigned the area type value associated with the nearest TAZ.

**Table 3-7 Area-type codes, from 1 to 7, based on population and employment density**

One-Mile “Floating” Population Density (Pop/Sq mi)	One- mile “Floating” Employment Density (Emp/Sq mi)						
	0-100	101-350	351-1,500	1,501- 3,550	3,551- 13,750	13,751- 15,000	15,001+
0-750	6	6	5	3	3	3	2
751-1,500	6	5	5	3	3	3	2
1,501-3,500	6	5	5	3	3	2	2
3,501-6,000	6	4	4	3	2	2	1
6,001-10,000	4	4	4	2	2	2	1
10,000-15,000	4	4	4	2	2	2	1
15,001+	2	2	2	2	2	1	1

### 3.2.5 Toll Parameter File

The Washington, D.C. region includes several tolled highway facilities that vary substantially in tolling policy. On some facilities, such as the Dulles Toll Road or the Governor Nice Bridge, toll values are fixed and are not a function of the time of day or day of the week. On other facilities, toll rates can vary throughout the day, either set in advance, with “fixed” tolls that vary by specific times of the day, or set dynamically, as a function of real-time congestion levels. The Intercountry Connector (ICC), between Prince George’s County and Montgomery County, is an example of a facility where fixed toll rates vary



by hour of the day according to a schedule that has been set in advance. The high-occupancy/toll (HOT) lanes on I-495, known as the I-495 Express Lanes, are an example of a toll facility where the toll rates are set dynamically, as a function of congestion levels. TPB staff reviews the tolling policy of private and publically operated facilities each year and strives to produce reasonably representative toll values for each time period.<sup>15</sup>

There are two cost-related variables in the link.dbf file that allow the user to flexibly specify tolls in the network: the *TOLL* and *TOLLGRP* variables. The **TOLL** variable is a monetary value of the fee charged to traverse the link. The network database contains tolls for each year, up to the current year. This allows the user to produce a year-2012 network, for instance, that would contain the tolls as they were in 2012. For forecast years, the network contains the current year’s tolls in current-year cents. **TOLLGRP** is a variable that is used to identify tolling locations in the network. A TOLLGRP code of 1 identifies existing facilities where fixed-rate tolls are collected at specific locations. The Dulles Toll Road (VA 267) is an example of this. A TOLLGRP code of 2 identifies links on the ICC. A TOLLGRP code of 3 or greater identifies links on a variably priced facility, such as the I-495 Express Lanes. The TOLLGRP rates are specified in the toll parameter/escalation file (TOLL\_ESC.dbf). Table 3-8 lists the specific variables in the file.

**Table 3-8 Toll parameter file (Toll\_esc.dbf)**

File Name	Variable Name	Description
Toll_Esc.dbf	Tollgrp	Toll group code, 1=existing fixed-toll facility, 2=ICC, 3+= VA HOT lane
	Escfac	Deflation factor override
	Dstfac	Distance (per mile)-based toll factor in current-year cents/dollar (optional)
	AM_Tftr	AM period Toll factor (no units)
	PM_Tftr	PM period toll factor (no units)
	OP_Tftr	Off-peak period toll factor (no units)
	AT_Min	Area Type minimum override (optional)
	AT_Max	Area Type maximum override (optional)
TollType	<i>Toll Type (1=operating in calibration year, 2= operating after calibration year)</i>	

Ref: "I:\ateam\docum\fy14\2013CLRP\_Network\_Report\2013CLRP\_NW\_Rept\_Tables\Lst\_of\_NW\_Fare\_Files.xlsx"

The file contains a base distance-based toll factor (DSTFAC), in cents/mile, and time-period-specific variables (e.g., AM\_TFTR and PM\_TFTR) that allow one to transform distance-based factors to time-period-specific toll rates. With the exception of the case where TOLLGRP = 1, the TOLL and TOLLGRP factors should not be invoked together. If the TOLL value of a given link is non-zero and the TOLLGRP value equals zero, the highway network building process automatically imposes a TOLLGRP override value of “1”. TOLLGRP codes that are used should therefore be greater than “1.”

<sup>15</sup> See, for example, Jane Posey to Files, “Toll Rates for the 2013 CLRP & FY2013-2018 TIP Air Quality Conformity Analysis,” Memorandum, December 10, 2013.

The highway building process ultimately creates six period-specific toll attributes: AMTOLL, PMTOLL, OPTOLL (tolls by time-of-day on all toll facilities) and AMTOLL\_VP, PMTOLL\_VP, OPTOLL\_VP (tolls by time-of-day on variable priced facilities only). Four toll facilities are modeled in base-year highway networks: the ICC, the Dulles Toll Road (VA 267), the Dulles Greenway, and the Harry W. Nice Memorial Bridge (between Charles County, Maryland and King George County, Virginia).

Figure 3-7 shows tolling locations on the Dulles Toll Road. Tolls on this facility have increased annually for the past several years. Current and past year's toll value updates are reflected in the network database. In the 2015 CLRP network database, all forecast year networks reflect year 2015 toll values as shown in Table 3-9.

Note that in this table, the nominal toll rate is fixed at the year-2015 value through 2020, which implies that real tolls (prices) are dropping from 2015 to 2020.

**Figure 3-7 Dulles Toll Road: Toll facilities locations**



**Table 3-9 Dulles Toll Road (VA 267): Toll Inks**

Segment	A	B	Location	Direction	Toll Values (in 2015 cents)
					2015
1	35130	35133	Main Toll Plaza-Rt 684 Interchange (LOV)	Inbound	250
	35136	35129	Main Toll Plaza-Rt 684 Interchange (LOV)	Outbound	250
	35130	35132	Spring Hill Road- Off Ramp	Inbound	100
	35132	35133	Spring Hill Road- On Ramp	Inbound	100
	35136	35131	Spring Hill Road- Off Ramp	Outbound	100
	35131	35129	Spring Hill Road- On Ramp	Outbound	100
	2	35097	35096	Rt 674 (Hunter Mill Road) - On Ramp	Inbound
35194		35095	Rt 674 (Hunter Mill Road) - Off Ramp	Outbound	100
3	35101	35100	Rt 828 (Wiehle Avenue)- On Ramp	Inbound	100
	35196	35099	Rt 828 (Wiehle Avenue)- Off Ramp	Outbound	100
4	35105	35104	Rt 602 (Reston Pkwy)-On Ramp	Inbound	100
	35198	35103	Rt 602 (Reston Pkwy)-Off Ramp	Outbound	100
5	35287	35291	Rt 7100 (Fairfax Co. Pkwy)- On Ramp	Inbound	100
	35289	35286	Rt 7100 (Fairfax Co. Pkwy)- Off Ramp	Outbound	100
6	35109	35108	Rt 228 (Centreville Road) -On Ramp	Inbound	100
	35200	35107	Rt 228 (Centreville Road) -Off Ramp	Outbound	100

Ref: I:\ateam\docum\FY16\2015CLRP\_Network\_Report\NW\_Report\_Tables\Grnway\_Dulles\_v2.3.57a.xlsx

Note: Toll rates effective January 1, 2014. Year 2015 toll values are used for all forecast years.

The 14-mile Dulles Greenway connects to the Dulles Toll Road at Route 28 (at Dulles International Airport), and extends west to Route 15 at Leesburg, as shown in Figure 3-8 and Figure 3-9. Dulles Greenway tolls (shown in Table 3-10, for segments 1-4, and Table 3-11, for segments 5-8) are coded in highway networks based on a weighted average of the cash rates, E-ZPass rates, and congestion-management tolling. Survey data indicate that the E-ZPass markets account for roughly three-fourths of users and that about half the travel occurs during the times when the congestion-management tolls are in effect. The main toll facility is represented west of the Route 28 (Sully Road) interchange with a weighted toll of \$5.75 in 2015 and beyond. A weighted toll of \$4.75 in 2015 and beyond is used for all westbound and eastbound on-ramps at Routes 28, 606, and 607. A weighted toll of \$3.96 in 2015 and beyond is coded for all westbound and eastbound on-ramps at Routes 772, Claiborne Parkway, and Belmont Ridge Road. A weighted toll of \$3.06 in 2015 and beyond is coded for all on-ramps at Route 653. No toll is charged at the future Battlefield Parkway interchange.

Figure 3-8 Dulles Greenway: Toll facilities locations (Map 1 of 2)

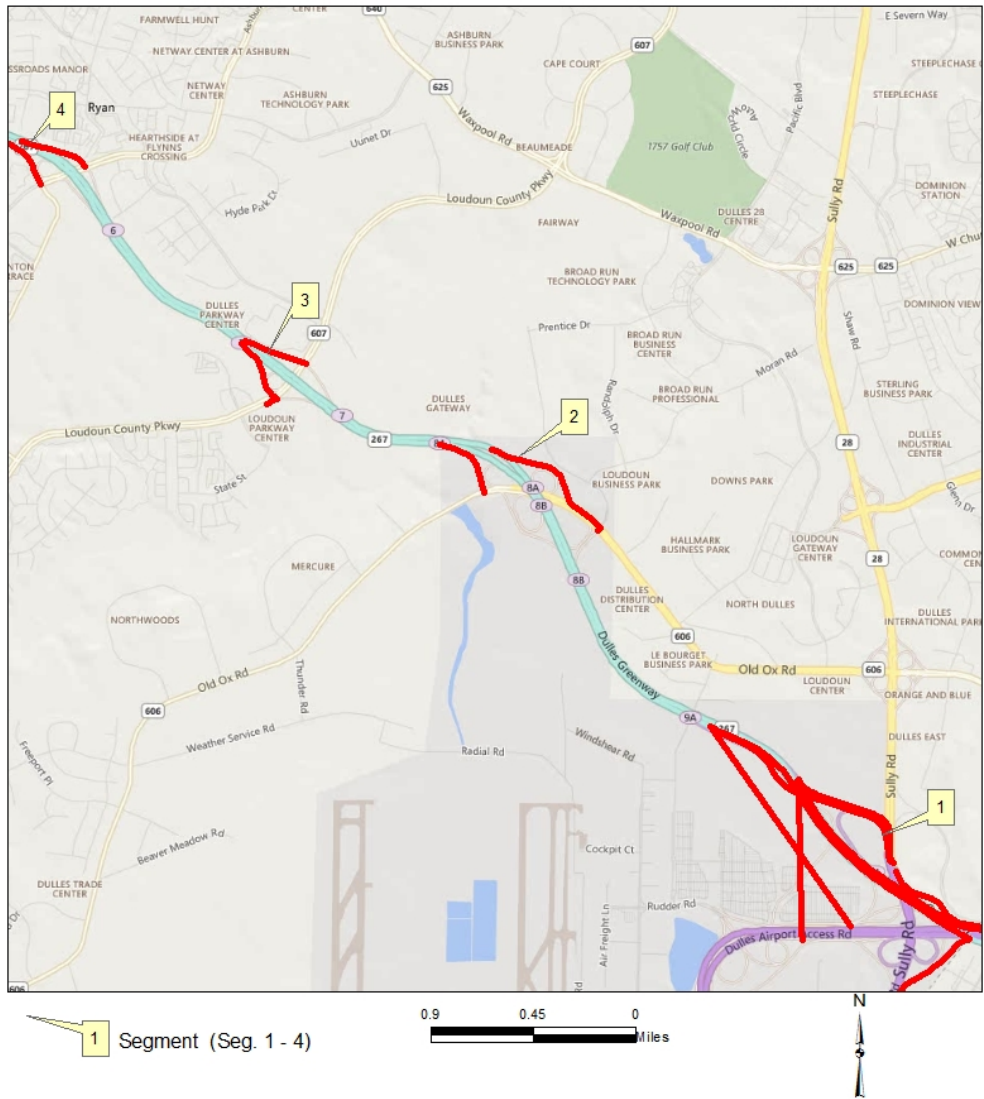

Table 3-10 Dulles Greenway Toll links (Segments 1-4)

Seg	Anode	Bnode	Location	Direction	Toll Values (in 2015 cents)	
					2015	
1	38046	38098	Rt. 28	Outbound		575
	38266	34810	Rt. 28	Inbound		575
	38025	34810	Rt. 28 Toll Plaza on- Ramp	Inbound		100
	38046	38018	Rt. 28 Toll Plaza off- Ramp	Outbound		100
	38064	38098	Rt. 28 to Dulles Greenway on-Ramp	Outbound		475
	38266	38064	Dulles Greenway to Rt. 28 off-Ramp	Inbound		475
	38043	38098	Airport Access road to Dulles Greenway on- Ramp	Outbound		475
	38266	38047	Dulles Greenway to Airport Access road off Ramp	Inbound		475
2	38029	38271	Rt 606 (Old Ox Road) on-Ramp	Outbound		475
	38272	38273	Rt 606 (Old Ox Road) off-Ramp	Inbound		475
3	38100	38276	Rt 607 (Loudoun Co. Pkwy) on-Ramp	Outbound		475
	38277	38278	Rt 607 (Loudoun Co. Pkwy) off-Ramp	Inbound		475
4	38065	38281	Rt 772 (Old Ryan Rd) on-Ramp	Outbound		396
	38282	38283	Rt 772 (Old Ryan Rd) off-Ramp	Inbound		396

Figure 3-9 Dulles Greenway: Toll facilities locations (Map 2 of 2)

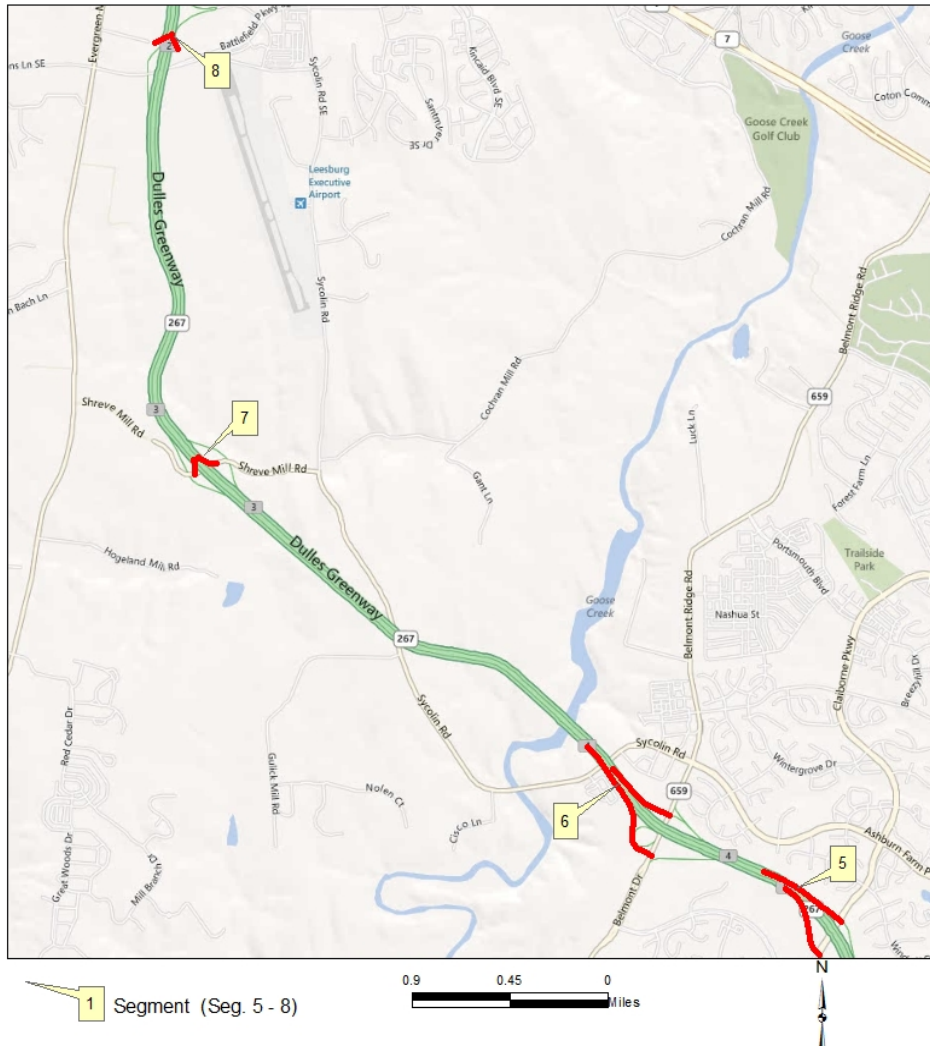

Table 3-11 Dulles Greenway Toll links (Segments 5-8)

Seg	Anode	Bnode	Location	Direction	Toll Values (in 2015 cents)	
					2015	
5	38069	38289	Claiborn Pkwy on-Ramp	Outbound		396
	38290	38291	Claiborn Pkwy off-Ramp	Inbound		396
6	38070	38294	Belmont Ridge Road on-Ramp	Outbound		396
	38295	38296	Belmont Ridge Road off-Ramp	Inbound		396
7	38071	38299	Shreve Mill Road on-Ramp	Outbound		306
	38300	38301	Shreve Mill Road off-Ramp	Inbound		306
8	38072	38304	Battlefield Pkwy on-Ramp	Outbound		na
	38305	38306	Battlefield Pkwy off-Ramp	Inbound		na

Note: Toll rates effective March 2015. Year 2015 toll values are used for all forecast years.

Ref: I:\ateam\docum\FY16\2015CLRP\_Network\_Report\NW\_Report\_Tables\Grnway\_Dulles\_v2.3.57a.xlsx

Table 3-12 shows that a weighted (E-ZPass vs. cash) toll of \$2.76 is coded on the Harry W. Nice Bridge, in both directions, on the forecast-year network links.

**Table 3-12 Harry W. Nice Bridge toll links**

				Toll Values (in 2015 cents)
A	B	Location	Direction	2015
50002	50001	Virginia - Maryland	Inbound	276
50001	50002	Maryland - Virginia	Outbound	276

Note: Toll rates effective July 1, 2013. Year 2015 toll values are used for all forecast years.

Ref: I:\ateam\docum\FY16\2015CLRP\_Network\_Report\NW\_Report\_Tables\Grnway\_Dulles\_v2.3.57a.xlsx

Starting in 2012, the Intercounty Connector (ICC) in Maryland was included in all networks representing the year 2012 and beyond. HOT lane operations on I-95/I-395 between Turkeycock Run in Fairfax County and VA 610 (Garrisonville Road) in Stafford County are included in all networks representing 2015 and beyond. HOV/HOT lanes on I-95 between VA 610 and VA 17 in Spotsylvania County are in all networks representing 2025 and beyond. On I-495 (Capital Beltway) in Virginia HOT lane operations are included as follows:

- Beginning in 2013: From Hemming Avenue to south of Old Dominion Drive;
- Beginning in 2015: From south of Old Dominion Drive to the George Washington Parkway;
- Beginning in 2030: From the George Washington Parkway to the American Legion Bridge.

As discussed earlier in this chapter, in the COG/TPB highway networks, the toll group variable (TOLLGRP) indicates the type of tolling on the facility. TOLLGRP code 1 is assigned for existing tolled facilities (Dulles Toll Road, Dulles Greenway and the Harry W. Nice Bridge). The ICC in Maryland is modeled as TOLLGRP code 2 with fixed toll values of 26.38 cents during peak periods and 20.05 cents during off-peak periods (in 2015 cents). For all other tolled facilities, the TOLLGRP code varies and is used to develop variably priced tolls.

For the variably priced HOT lane facilities, I-95/I-395, and I-495 Capital Beltway, in Virginia, the network link toll value (TOLL) is left blank and the toll facility type variable (TOLLGRP) is used to access lookup tables of fixed fees and per-mile rates. The tolls will vary based on the level of congestion. TOLLGRP codes 3-39 are used for I-495 and TOLLGRP codes 60-135 are used for I-95/I-395.

**Table 3-13** and

**Table 3-14** display toll values (in 2015 cents) by time period and direction for I-95/I-395 and I-495 (Capital Beltway) HOT Lanes.

**Table 3-13 Toll values on I-495 Capital Beltway in Virginia (in 2015 cents) - 2015 CLRP**

North bound HOT Lane Segment	Toll Group	Distance (in mile)	2015			2017			2020			2025			2030			2040				
			AM	PM	OP	AM	PM	OP	AM	PM	OP	AM	PM	OP	AM	PM	OP	AM	PM	OP		
Hemming Ave. --> VA 620 (Braddock Rd)	7	0.17	3	3	3	3	3	3	3	3	3	3	3	3	3	3	3	3	3	5	3	3
At VA 620	9	0.84	17	17	13	17	17	13	17	17	13	17	17	13	17	17	13	17	17	13	17	13
VA 620 --> VA 650 (Gallows Rd.)	11	2.97	59	59	45	59	59	45	59	59	45	59	59	45	59	59	45	59	59	45	59	45
VA 650 --> US 29 (Lee Highway)	13	1.16	104	23	17	104	23	17	128	23	17	128	23	17	151	23	17	197	23	17	197	23
US 29 --> I-66	15	0.35	7	7	5	7	7	5	7	7	5	7	7	5	7	7	5	7	7	5	7	5
At I-66	17	0.59	12	12	9	12	12	9	12	12	9	12	12	9	12	12	9	12	12	9	12	9
N. of I-66 --> VA 7 (Leesburg Pike)	19	1.40	126	28	21	112	28	21	154	28	21	224	28	21	266	28	21	280	28	21	280	28
VA 7 --> S. of VA 123 (Chain Bridge Rd)	21	0.95	19	19	14	19	19	14	19	19	14	19	19	14	38	19	14	19	19	14	19	14
At VA 123	23	0.11	2	2	2	2	2	2	2	2	2	2	2	2	2	2	2	2	2	2	2	2
VA 123 --> S. of VA 267 (Dulles Toll Rd)	25	0.20	4	4	3	4	4	3	4	4	3	4	4	3	4	4	3	4	4	3	4	3
S. of VA 267	27	0.15	3	3	2	3	3	2	3	3	2	3	3	2	3	3	2	3	3	2	3	2
At VA 267	29	0.58	12	12	9	12	12	9	12	12	9	12	12	9	12	12	9	12	12	9	12	9
N of VA 267 --> VA 738 (old Dominion Dr)	31	0.81	16	16	12	16	16	12	16	16	12	16	16	12	16	16	12	24	24	12	24	12
VA 738 --> VA 193 (George Town Pike)	33	0.52	NA	NA	NA	NA	NA	NA	NA	NA	NA	10	10	8	10	10	8	16	16	8	16	8
At VA 193	35	0.68	NA	NA	NA	NA	NA	NA	NA	NA	NA	14	14	10	14	14	10	20	20	10	20	10
N of VA 193 --> GW Pkwy	37	0.22	NA	NA	NA	NA	NA	NA	NA	NA	NA	4	4	3	4	4	3	7	7	3	7	3
GW Pkwy --> American Legion Brdg.	39	0.79	NA	NA	NA	NA	NA	NA	NA	NA	NA	NA	NA	NA	126	103	12	174	126	12	174	12

South bound HOT Lane Segment	Toll Group	Distance (in mile)	2015			2017			2020			2025			2030			2040				
			AM	PM	OP	AM	PM	OP	AM	PM	OP	AM	PM	OP	AM	PM	OP	AM	PM	OP		
American Legion Brdg. --> GW Pkwy	4	0.78	NA	NA	NA	NA	NA	NA	NA	NA	NA	NA	NA	211	125	12	211	164	12	211	164	12
GW Pkwy --> N. of VA 193 (George Town Pike)	6	0.40	NA	NA	NA	NA	NA	NA	NA	NA	NA	8	8	6	16	8	6	20	12	6	20	12
VA 193 --> VA 738 (old Dominion Dr)	8	1.03	NA	NA	NA	NA	NA	NA	NA	NA	NA	21	21	15	21	21	15	21	21	15	21	15
VA 738 --> VA 694 (Lewinsville Rd)	10	0.70	14	14	11	14	14	11	14	14	11	14	14	11	14	14	11	14	14	11	14	11
VA 694 --> N of VA 267 (Dulles Toll Rd)	12	0.18	4	4	3	4	4	3	4	4	3	4	4	3	4	4	3	4	4	3	4	3
At VA 267	14	0.57	11	11	9	11	11	9	11	11	9	11	11	9	11	11	9	11	11	9	11	9
S. of VA 267	16	0.12	2	2	2	2	2	2	2	2	2	2	2	2	2	2	2	2	2	2	2	2
VA 267 --> VA 123 (Chain Bridge Rd)	18	0.20	4	4	3	4	4	3	4	4	3	4	4	3	4	4	3	4	4	3	4	3
At VA 123	20	0.12	2	2	2	2	2	2	2	2	2	2	2	2	2	2	2	2	2	2	2	2
VA 123 --> VA 7 (Leesburg Pike)	22	0.96	19	19	14	19	19	14	19	19	14	19	19	14	19	19	14	19	19	14	19	14
VA 7 --> N. of I-66	24	1.52	30	122	23	30	106	23	30	167	23	30	289	23	30	258	23	30	198	23	30	198
At I-66	26	0.44	9	9	7	9	9	7	9	9	7	9	9	7	9	9	7	9	9	7	9	7
I-66 --> US 29 (Lee Highway)	28	0.43	9	9	6	9	9	6	9	9	6	9	9	6	9	9	6	9	9	6	9	6
US 29 --> VA 650 (Gallows Rd.)	30	1.17	23	59	18	23	59	18	23	82	18	23	94	18	23	152	18	23	211	18	23	211
VA 650 --> N. of VA 620 (Braddock Rd)	32	2.77	55	55	42	55	55	42	55	55	42	55	55	42	55	55	42	55	55	42	55	42
At VA 620	34	1.00	20	20	15	20	20	15	20	20	15	20	20	15	20	20	15	20	20	15	20	15
VA 620 --> Hemming Ave.	36	0.04	1	1	1	1	1	1	1	1	1	1	1	1	1	1	1	1	1	1	1	1

Ref: "I:\ateam\docum\FY16\2015CLRP\_Network\_Report\NW\_Report\_Tables\2015CLRP\_TOLL\_Summary\_v2.3.57a.xlsx"

**Table 3-14 Toll values on I-395/I-95 Virginia (in 2015 cents) - 2015 CLRP**

North bound HOT Lane Segment	Toll Group	Distance (in mile)	2015			2017			2020			2025			2030			2040			
			AM	PM	OP	AM	PM	OP	AM	PM	OP	AM	PM	OP	AM	PM	OP	AM	PM	OP	
S. of US 1	61	0.31	NA	NA	NA	NA	NA	NA	NA	NA	6	6	5	6	6	5	6	6	5		
At US 1	63	1.28	NA	NA	NA	NA	NA	NA	NA	NA	26	26	19	26	26	19	26	26	19		
N. of US 1 ~ VA 3	65	4.12	NA	NA	NA	NA	NA	NA	NA	NA	82	82	62	82	82	62	82	82	62		
N. of VA 3	67	1.75	NA	NA	NA	NA	NA	NA	NA	NA	35	35	26	35	35	26	35	35	26		
N. of VA 3 ~ N. of US 17	69	2.20	NA	NA	NA	NA	NA	NA	NA	NA	44	44	33	44	44	33	44	44	33		
S. of US 17 ~ S. of Ramoth Church Rd	71	3.41	NA	NA	NA	NA	NA	NA	NA	NA	68	68	51	68	68	51	68	68	51		
S. of Ramoth Church Rd ~ N. of Courthouse Rd	73	3.99	NA	NA	NA	NA	NA	NA	NA	NA	80	80	60	80	80	60	80	80	60		
N. of Courthouse Rd ~ Garrisonville Rd	75	1.88	NA	NA	NA	NA	NA	NA	NA	NA	38	38	28	38	38	28	38	38	28		
N. of Garrisonville Rd	77	0.87	17	17	13	17	17	13	17	17	13	17	13	17	17	13	17	17	13		
N. of Garrisonville Rd ~ Russell Rd	79	3.67	73	73	55	73	73	55	147	73	55	477	73	55	661	73	55	1285	73	55	
N. of Russell Rd ~ S. of VA 234	81	3.39	68	68	51	68	68	51	68	68	51	102	68	51	170	68	51	271	68	51	
S. of VA 234 ~ Cardinal Dr	83	3.86	77	77	58	77	77	58	77	77	58	116	77	58	193	77	58	309	77	58	
Cardinal Dr ~ VA 642	85	2.12	127	42	32	191	42	32	254	42	32	297	42	32	339	42	32	509	42	32	
N. of VA 642 ~ VA 294	87	0.66	191	13	10	198	13	10	363	13	10	389	13	10	370	13	10	581	13	10	
At VA 294	89	0.73	15	15	11	22	15	11	15	15	11	29	15	11	66	15	11	102	15	11	
N. of VA 294 ~ VA 123	91	1.71	34	34	26	34	34	26	34	26	34	26	34	26	34	26	34	26	171	34	26
N. of VA 123 ~ US 1	93	1.42	99	28	21	114	28	21	156	28	21	185	28	21	199	28	21	213	28	21	
N. of US 1 ~ N. of VA 611	95	1.84	129	37	28	147	37	28	202	37	28	239	37	28	258	37	28	276	37	28	
N. of VA 611 ~ VA 638	97	1.10	77	22	17	88	22	17	121	22	17	121	22	17	143	22	17	187	22	16	
VA 638 ~ VA 7100	99	1.29	103	26	19	129	26	19	168	26	19	155	26	19	168	26	19	206	26	19	
At VA 7100	101	0.98	20	20	15	20	20	15	20	20	15	20	20	15	20	20	15	29	20	15	
VA 7100 ~ VA 289	103	1.39	28	28	21	28	28	21	28	28	21	28	28	21	28	28	21	28	28	21	
At VA 289	105	0.03	1	1	0	1	1	0	1	1	0	1	1	0	1	1	0	1	1	0	
VA 613 ~ VA 644	107	0.41	41	8	6	41	8	6	74	8	6	78	8	6	82	8	6	90	8	6	
At VA 644	109	0.32	51	6	5	48	6	5	58	6	5	64	6	5	64	6	5	74	6	5	
VA 644 ~ S. of I-495	111	0.49	172	10	7	191	10	7	230	10	7	250	10	7	284	10	7	328	10	7	
At I-495	113	0.60	12	12	9	12	12	9	12	12	9	12	12	9	12	12	9	12	12	9	
N. of I-495	115	1.48	30	30	22	30	30	22	30	30	22	30	30	22	30	30	22	30	30	22	

South bound HOT Lane Segment	Toll Group	Distance (in mile)	2015			2017			2020			2025			2030			2040		
			AM	PM	OP	AM	PM	OP	AM	PM	OP	AM	PM	OP	AM	PM	OP	AM	PM	OP
VA 236 ~ VA 648	76	0.28	6	6	4	6	6	4	6	6	4	6	6	4	6	6	4	6	6	4
VA648 ~ N. of I-495	78	1.48	30	30	22	30	30	22	30	30	22	30	30	22	30	30	22	30	30	22
At I-495	80	0.60	12	12	9	12	12	9	12	12	9	12	12	9	12	12	9	12	12	9
I-495 ~ VA 644	82	0.49	10	172	7	10	186	7	10	230	7	10	260	7	10	348	7	10	426	7
At VA 644	84	0.32	6	45	5	6	45	5	6	61	5	6	61	5	6	64	5	6	80	5
VA 644 ~ VA 289	86	0.17	3	3	3	3	12	3	3	22	3	3	20	3	3	24	3	3	26	3
At VA 289	88	0.49	10	10	7	10	10	7	10	10	7	10	10	7	10	10	7	10	10	7
VA 613 ~ VA 7100	90	1.17	23	23	18	23	23	18	23	23	18	23	23	18	23	23	18	23	23	18
At VA 7100	92	0.98	20	20	15	20	20	15	20	20	15	20	20	15	20	20	15	20	20	15
VA 7100 ~ VA 638	94	1.29	26	26	19	26	26	19	26	26	19	26	26	19	26	26	19	26	26	19
VA 638 ~ N. of VA 611	96	1.24	25	25	19	25	25	19	25	25	19	25	25	19	25	25	19	25	25	19
At VA 611	98	0.35	7	7	5	7	7	5	7	11	5	7	7	5	7	14	5	7	18	5
VA 611 ~ N. of US 1	100	0.98	20	20	15	20	20	15	20	29	15	20	20	15	20	39	15	20	49	15
At US 1	102	0.60	12	12	9	12	12	9	12	18	9	12	12	9	12	24	9	12	30	9
US 1 ~ N. of VA 123	104	1.28	26	26	19	26	26	19	26	26	19	26	26	19	26	26	19	26	26	19
VA 123 ~ N. of VA 294	106	1.87	37	37	28	37	37	28	37	37	28	37	37	28	37	37	28	37	37	28
VA294 ~ N. of VA 642	108	1.56	31	31	23	31	31	23	31	94	23	31	125	23	31	140	23	31	296	23
At VA 642	110	0.26	5	5	4	5	5	4	5	5	4	5	5	4	5	8	4	5	13	4
VA 642 ~ Cardinal Dr	112	1.56	31	31	23	31	31	23	31	78	23	31	140	23	31	156	23	31	296	23
S. of Cardinal Dr ~ S. of VA 234	114	3.76	75	75	56	75	75	56	75	75	56	75	113	56	75	188	56	75	376	56
S. of VA 234 ~ N. of VA 619	116	1.04	21	21	16	21	21	16	21	21	16	21	21	16	21	21	16	21	21	16
VA 619 ~ S. of Russell Rd	118	3.57	71	71	54	71	71	54	71	71	54	71	107	54	71	250	54	71	571	54
S. of Russell Rd ~ N. of Garrisonville Rd	120	2.45	49	49	37	49	49	37	49	49	37	49	74	37	49	172	37	49	490	37
N. of Garrisonville Rd ~ N. of Courthouse Rd	122	0.93	19	19	14	19	19	14	19	19	14	19	19	14	19	19	14	19	19	14
N. of Courthouse Rd ~ S. of Ramoth Church Rd	124	3.93	NA	NA	NA	NA	NA	NA	NA	NA	79	79	59	79	79	59	79	79	59	
S. of Ramoth Church Rd ~ N. of US 17	126	3.41	NA	NA	NA	NA	NA	NA	NA	NA	68	68	51	68	68	51	68	68	51	
N. of US 17 ~ S. of US 17	128	2.21	NA	NA	NA	NA	NA	NA	NA	NA	44	44	33	44	44	33	44	44	33	
S. of US 17 ~ N. of US 1	130	5.88	NA	NA	NA	NA	NA	NA	NA	NA	118	118	88	118	118	88	118	118	88	
At US 1	132	1.28	NA	NA	NA	NA	NA	NA	NA	NA	26	26	19	26	26	19	26	26	19	
S. of US 1	134	0.31	NA	NA	NA	NA	NA	NA	NA	NA	6	6	5	6	6	5	6	6	5	

\*0.93 miles for years 2015-2020 where SB HOT Lanes ends. 2.78 miles for years 2025-2040.

Ref: " I:\ateam\docum\FY16\2015CLRP\_Network\_Report\NW\_Report\_Tables\2014CLRP\_TOLL\_Summary\_v2.3.57a.xlsx"



Effective year 2017 I-66 inside the Capital Beltway (from US Rt. 29 in Rosslyn to I-495) will be converted to a managed express lane facility with dynamic, congestion-based tolling for all vehicles with less than three occupants, in both directions during the morning and evening peak periods. On the 10 miles stretch of I-66 inside the Beltway, during the peak periods, vehicles not meeting the occupancy requirement will pay a toll, using electronic toll collection equipment, at a variable rate based on the level of congestion to ensure free-flow condition.<sup>16</sup>

In all networks representing the year 2017 and beyond, on I-66 inside the Beltway, TOLLGRP codes of 200-222 (East/inbound) and TOLLGRP codes of 250-271 (West/outbound) are used. The TOLLGRP code is coded on each link to allow flexibility for placement of future access points. Table 3-15 displays toll values (in 2015 cents) summarized by segment, time period and direction for I-66 inside the Capital Beltway. **Figure 3-10** shows I-66 inside the Capital Beltway.

**Table 3-15 Toll values on I-66 Inside the Capital Beltway (in 2015 cents) - 2015 CLRP**

I-66 Inside the Beltway: East bound			Toll	Distance	2015			2017			2020			2025			2030			2040			
HOT Lane Segment	Group	(in mile)			AM	PM	OP	AM	PM	OP	AM	PM	OP	AM	PM	OP	AM	PM	OP	AM	PM	OP	
I-495 - Leesburg Pike	200 - 201	1.11	NA	NA	NA	22	22	17	22	22	17	22	22	17	22	22	17	22	22	17	78	22	17
Leesburg Pike - Dulles Toll Rd.	202 - 205	0.78	NA	NA	NA	26	16	11	16	16	11	31	16	11	38	16	11	16	11	16	16	11	11
Dulles Toll Rd. - N. Sycamore St.	206 - 210	2.01	NA	NA	NA	213	40	30	217	40	30	277	40	30	304	40	30	206	40	30	206	40	30
N. Sycamore St. - N. George Mason Dr	211 - 213	1.89	NA	NA	NA	492	37	29	434	37	29	434	37	29	474	37	29	285	37	29	285	37	29
N. George Mason Dr - N Quincy St.	214 - 215	0.88	NA	NA	NA	23	17	14	24	17	14	26	17	14	28	17	14	112	17	14	112	17	14
N Quincy St. - N. Spout Run Pkwy	216 - 218	1.33	NA	NA	NA	67	27	21	73	27	21	94	27	21	106	27	21	260	27	21	260	27	21
N. Spout Run Pkwy - Francis Scott Key Bridge	219 - 222	1.33	NA	NA	NA	37	26	20	37	26	20	44	26	20	48	26	20	107	26	20	107	26	20

I-66 Inside the Beltway: West bound			Toll	Distance	2015			2017			2020			2025			2030			2040			
HOT Lane Segment	Group	(in mile)			AM	PM	OP	AM	PM	OP	AM	PM	OP	AM	PM	OP	AM	PM	OP	AM	PM	OP	
Francis Scott Key Bridge - N.Spout Run Pkwy	250 - 253	1.12	NA	NA	NA	23	30	17	23	38	17	23	42	17	23	45	17	23	84	17	23	84	17
N.Spout Run Pkwy - N. Quincy St.	254 - 256	1.73	NA	NA	NA	35	138	26	35	140	26	35	167	26	35	184	26	35	246	26	35	246	26
N. Quincy St. - N. George Mason Dr.	257	0.79	NA	NA	NA	16	24	12	16	40	12	16	40	12	16	47	12	16	95	12	16	95	12
N. George Mason Dr. - N. Sycamore St.	258 - 259	1.81	NA	NA	NA	36	36	27	36	36	27	36	36	27	36	55	27	36	272	27	36	272	27
N. Sycamore St. - Dulles Toll Rd.	260 - 265	1.9	NA	NA	NA	38	317	28	38	322	28	38	322	28	38	396	28	38	107	28	38	107	28
Dulles Toll Rd. - Leesburg Pike	266 - 269	0.95	NA	NA	NA	19	19	14	19	19	14	19	19	14	19	19	14	19	19	14	19	19	14
Leesburg Pike - I-495	270 - 271	0.78	NA	NA	NA	16	180	12	16	172	12	16	227	12	16	211	12	16	24	12	16	24	12

**Figure 3-10 I-66 inside the Capital Beltway: Express Lane Facility**

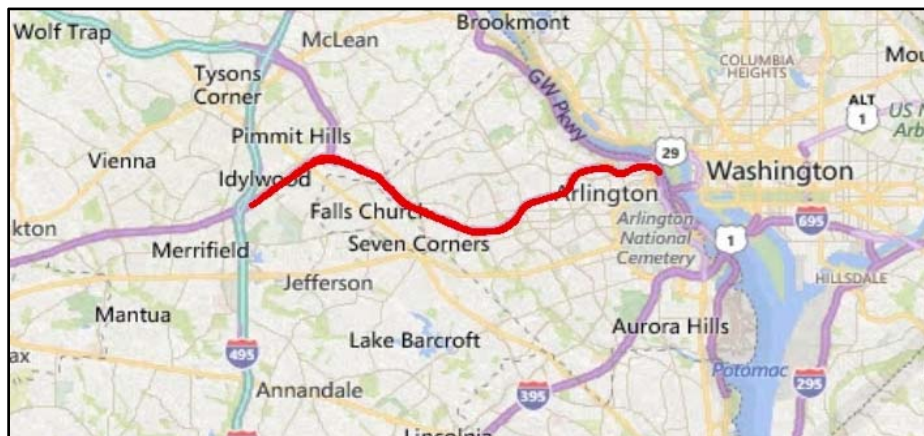

<sup>16</sup> Air Quality Conformity Analysis of the 2015 CLRP Amendment and FY2015-2020 TIP, National Capital Region Transportation Planning Board, October 21, 2015



Figure 3-12 Existing and Future Managed-lane facilities whose toll varies by time of day

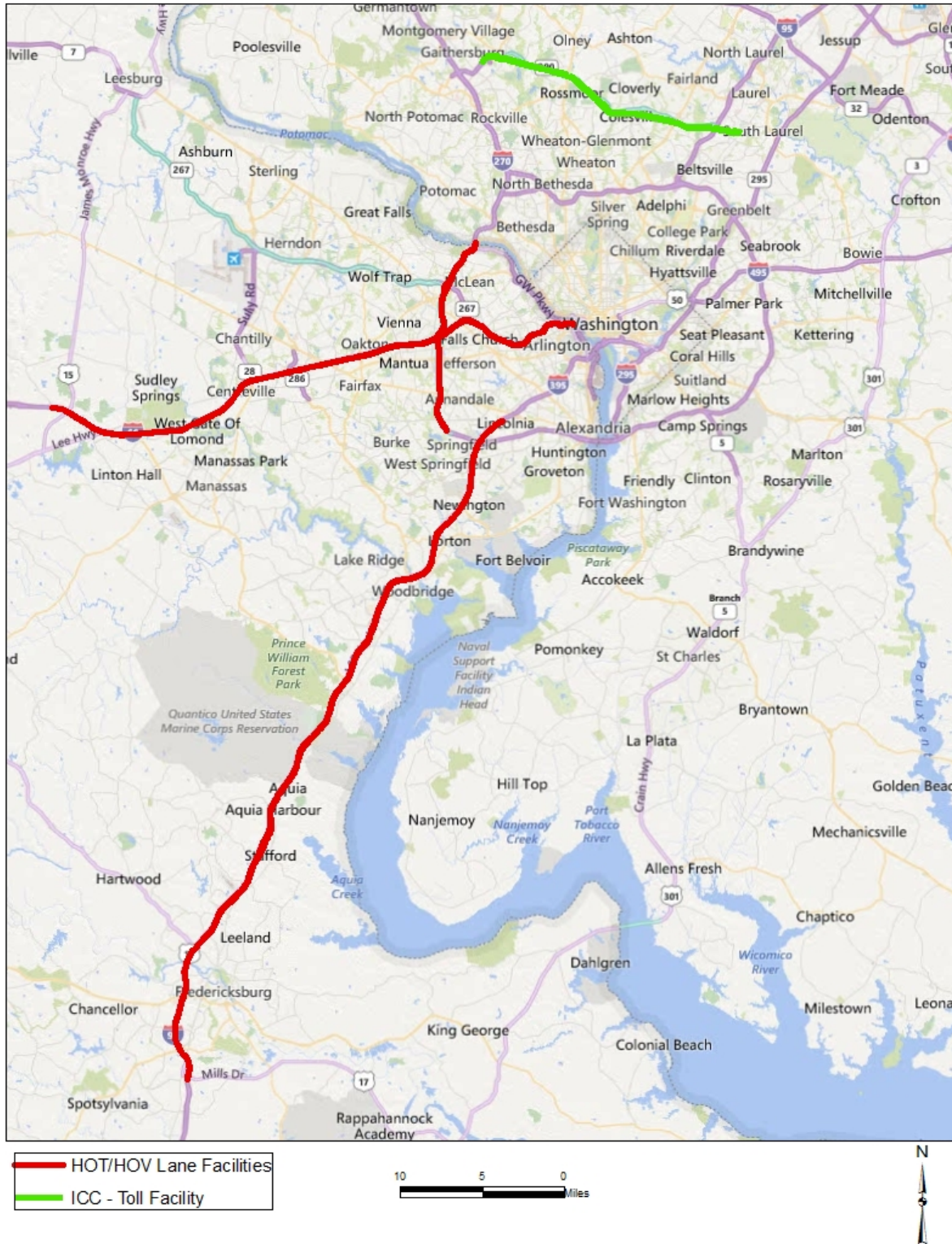

Source: C:\FY\_12\Network\_Docum\_2011\TollGrp\_12\_29\_15.mxd  
I:\ateam\docum\FY16\2015CLRP\_Network\_Report\ NW\_Report\_Tables\TollGrp\_1\_4\_16.jpg

### 3.2.6 Highway Network Screenlines

The network includes an attribute (SCREEN) which identifies 36 screenlines which are used for model summary or validation purposes.<sup>18</sup> The screenline locations are shown in Figure 3-13 and Figure 3-14.

**Figure 3-13 Highway Network screenlines: Inside the Beltway**

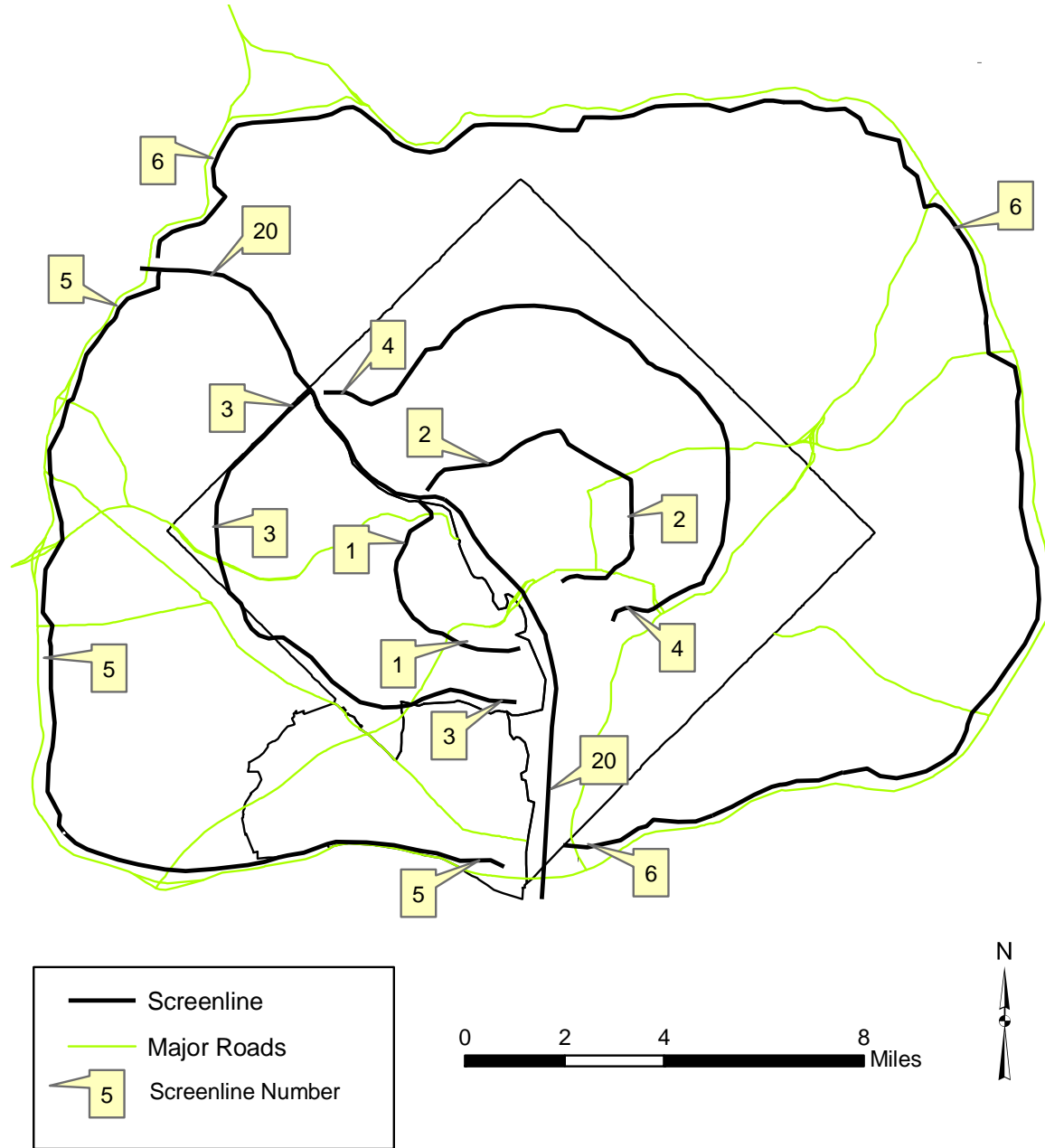

<sup>18</sup> The screen variable includes codes from 1 to 38, but the numbers 21 and 30 are unused

Figure 3-14 Highway network screenlines: Outside the Beltway

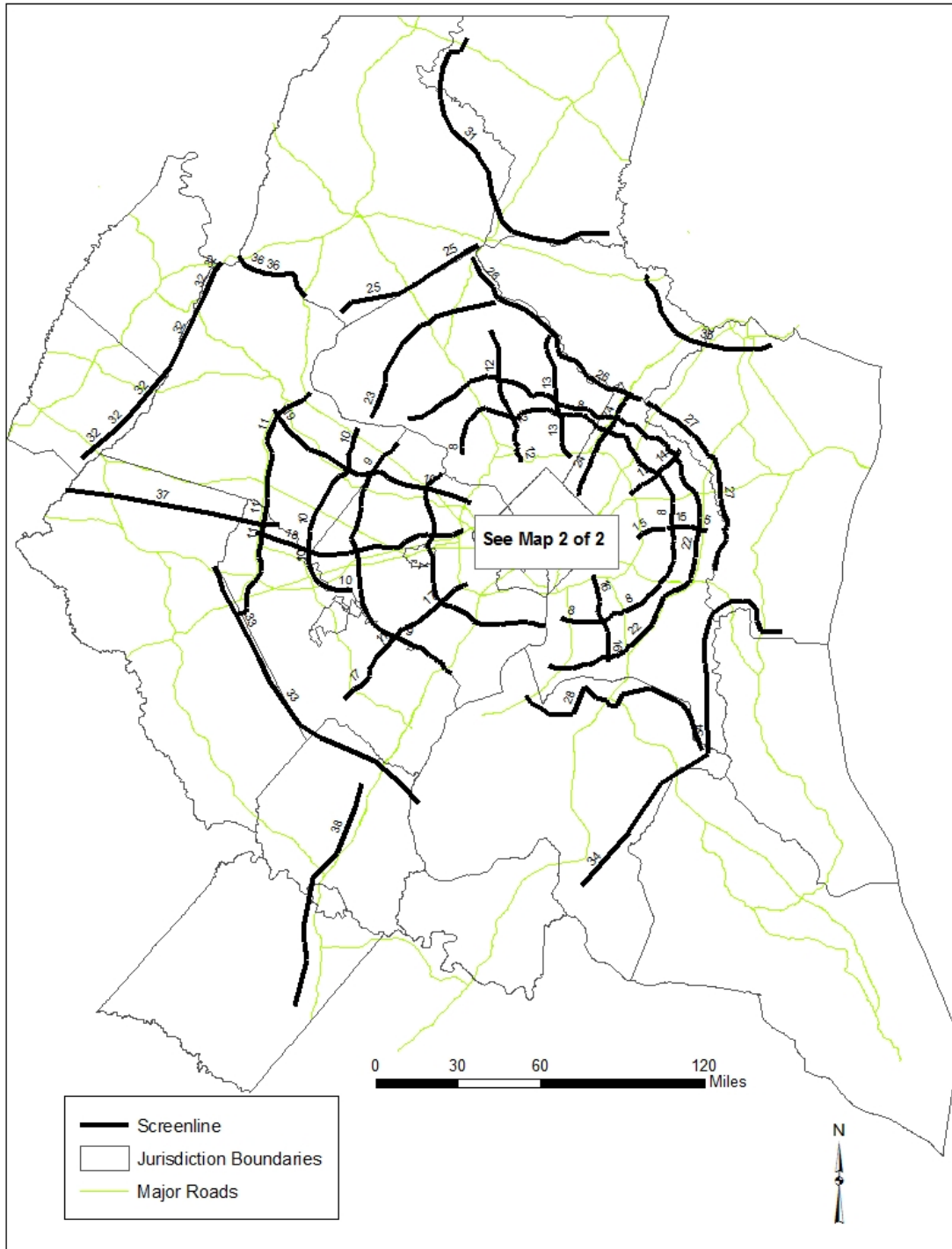

Ref.: I:\ateam\docum\fy14\2013CLRP\_Network\_Report\2013CLRP\_NW\_Rept\_Tables\Updated\_Screenline\_Map.jpg

### 3.2.7 2015 CLRP Highway Statistics

A summary of directional lane miles for the AM peak period is shown in Table 3-17.<sup>19</sup> In the 2015 highway network, there were almost 23,000 AM lane miles. By 2040, this number is predicted to increase by about 1,400, which is 6%, regionally. Fairfax Co. and Prince George's Counties are predicted to have the largest increase in AM lane miles from 2015 to 2040 – 316 and 246 miles, respectively – though this is not surprising since these counties are the largest jurisdictions in the region. The District of Columbia is the only jurisdiction that is predicted to have decline in the AM lane miles from 2015 to 2040, but the decrease is very small (less than 1 percent).

---

<sup>19</sup> Computation of AM lane miles **excludes** TAZ connectors (FTYPE=0) and Transit only links (AMLIMIT=9).

**Table 3-17 AM lane-miles for 2015 CLRP and FY2015-2020 TIP highway networks**

Jurisdiction Code	Jurisdiction	2015	2017	2020	2025	2030	2040	Diff 2040-2015	Ratio 2040/2015
0	District of Columbia	1,416	1,416	1,414	1,414	1,414	1,414	-2	1.00
1	Montgomery Co., Md.	2,648	2,651	2,706	2,735	2,766	2,767	120	1.05
2	Prince Georges Co., Md.	3,045	3,071	3,223	3,280	3,287	3,291	246	1.08
3	Arlington Co., Va.	513	513	514	514	514	517	4	1.01
4	City of Alexandria, Va.	323	323	325	326	326	326	3	1.01
5	Fairfax Co., Va.	3,298	3,344	3,359	3,526	3,539	3,614	316	1.10
6	Loudoun Co., Va.	1,615	1,662	1,809	1,756	1,771	1,788	173	1.11
7	Prince William Co., Va.	1,466	1,493	1,537	1,553	1,595	1,644	178	1.12
9	Frederick Co., Md.	1,663	1,669	1,688	1,688	1,717	1,717	54	1.03
10	Howard Co., Md.	960	960	978	1,048	1,048	1,048	88	1.09
11	Anne Arundel Co., Md.	1,401	1,401	1,418	1,452	1,452	1,452	51	1.04
12	Charles Co., Md.	851	851	851	851	859	859	8	1.01
14	Carroll Co., Md.	594	594	603	609	609	609	14	1.02
15	Calvert Co., Md	367	367	367	367	367	377	9	1.03
16	St. Mary's Co., Md.	461	461	461	461	461	461	0	1.00
17	King George Co., Va.	254	254	254	254	254	254	0	1.00
18	City of Fredericksburg, Va.	79	79	83	90	98	98	18	1.23
19	Stafford Co., Va.	580	580	594	621	625	636	56	1.10
20	Spotsylvania Co., Va.	441	441	441	458	465	493	52	1.12
21	Fauquier Co., Va.	795	795	795	795	795	795	0	1.00
22	Clark Co., Va.	161	161	161	161	161	161	0	1.00
23	Jefferson Co., WV.	278	278	278	278	278	278	0	1.00
		<b>23,210</b>	<b>23,365</b>	<b>23,861</b>	<b>24,235</b>	<b>24,399</b>	<b>24,596</b>	<b>1,387</b>	<b>1.06</b>

Ref: I:\ateam\docum\FY16\2015CLRP\_Network\_Report\NW\_Report\_Tables\ AM\_Lane\_Mile.xlsx

**Note:** TAZ connectors (FTYPE=0) and Transit only links (AMLIMIT=9) are **excluded**.

### 3.3 Transit Network Files

The transit network consists of transportation infrastructure, represented via nodes and links, plus the transit service that runs over that infrastructure. The transportation infrastructure includes the highway network, which is used by buses, and transit-only infrastructure, such as transit stations and rail links. The input files used to construct the transit networks are listed in Table 3-18.

**Table 3-18 Listing of transit network input files**

Filename	Description	Type	Source
Station.dbf	Station file: Metrorail, Comm.Rail, LRT stations/PNR lots & bus PNR lots	DBF	Geodatabase
AreaWalk.txt	Used to calculate zonal percent walk to transit values	Text	Travel Model-generated
met_node.tb	Metrorail stations	Text	Geodatabase
com_node.tb	Commuter rail stations	Text	Geodatabase
lrt_node.tb	LRT stations/stops	Text	Geodatabase
new_node.tb	BRT/streetcar stations/stops	Text	Geodatabase
met_pnrn.tb	Metrorail PNR lots	Text	Geodatabase
com_pnrn.tb	Commuter rail PNR lots	Text	Geodatabase
bus_pnrn.tb	Bus PNR lots	Text	Geodatabase
lrt_pnrn.tb	LRT PNR lots	Text	Geodatabase
new_pnrn.tb	BRT/streetcar PNR lots	Text	Geodatabase
met_link.tb	Metrorail links	Text	Geodatabase
com_link.tb	Commuter rail links	Text	Geodatabase
lrt_link.tb	LRT links	Text	Geodatabase
new_link.tb	BRT/streetcar links	Text	Geodatabase
met_bus.tb	Transfer link (walk) between Metrorail station and bus stop	Text	Geodatabase
com_bus.tb	Transfer link (walk) between commuter rail station and bus & LRT stop	Text	Geodatabase
lrt_bus.tb	Transfer link (walk) between LRT station and bus stop	Text	Geodatabase
new_bus.tb	Transfer link (walk) between BRT/streetcar stop and bus stop	Text	Geodatabase
MODE1AM...,MODE10AM.tb	AM transit line files	Text	Geodatabase
MODE1OP...,MODE10OP.tb	Off-peak transit line files	Text	Geodatabase

Ref: "I:\ateam\docum\FY15\2014CLRP\_Network\_Report\NW\_Report\_Tables\v23\_inputs.xlsx"

The input files are intended to serve as extensions to the highway network, which provides the infrastructure for bus and rail service. The table indicates that all of the transit link, node and line/route elements, and station file are produced directly from the geodatabase, with one exception: the AreaWalk.txt file which contains zonal walk-to-transit market areas. In the past, this file was produced



from an off-line ArcGIS procedure. The Ver. 2.3.57a travel model includes an automated/integrated transit walkshed process. The process is run using a Python/ArcPy script and does not require manual intervention from the user.<sup>20</sup> Before discussing the individual input files, the next section discusses transit and non-transit mode codes used in the transit network.

### 3.3.1 Transit and Non-Transit Mode Codes

The transit network consists of various types of transit services and transit vehicles. For example, a bus typically operates on a road in mixed traffic (i.e., with private vehicles, such as cars and trucks). But a bus can also operate as bus rapid transit (BRT), meaning that it may use a combination of normal roads (mixed traffic) and bus-only links/segments (separate right of way). Similarly, there are many rail transit modes that operate now, or will operate in the future, in the Washington, D.C. area, such as Metrorail, commuter rail, light rail transit (LRT) and streetcar. In terms of network coding, we currently differentiate the following six transit modes:

- Local bus
- Express bus
- Metrorail
- Commuter rail
- Light rail transit (LRT)
- Bus rapid transit (BRT) and streetcar

The last mode, BRT and streetcar, is designated for transit service that travels on a *combination* of separate right of way (where the vehicles are not mixed with other traffic) and regular streets (where the vehicles are mixed with other traffic). By contrast, the LRT mode is designed to be used for transit service that travels *predominantly* on its own right of way (hence, it is not encumbered by other traffic). Historically, the coding practice by COG/TPB staff has been to distinguish three separate categories for both local and express bus service:

- Metrobus
- Non-Metrobus, inner jurisdictions (referred to as “other primary”)
- Non-Metrobus, outer jurisdictions (referred to as “other secondary”)

This results in the ten transit modes shown in Table 3-19.

---

<sup>20</sup> For further details, see p. 5 of Milone et al., *User’s Guide for the MWCOG/NC RTPB Travel Forecasting Model, Version 2.3, Build 57a*.

**Table 3-19 Transit mode codes**

<b>Mode Code</b>	<b>Mode Description</b>
1	Local bus: Metrobus (also includes DC Circulator bus)
2	Express bus: Metrobus
3	Metrorail
4	Commuter rail
5	Light rail
6	Local bus: Other primary service (inner jurisdictions)
7	Express bus: Other primary service (inner jurisdictions)
8	Local bus: Other secondary service (outer jurisdictions)
9	Express bus: Other secondary service (outer jurisdictions)
10	BRT/streetcar

The transit path-builder, TRNBUILD, can combine average headways (frequencies) and run times (time from start to finish of the route), when two or more transit lines share the same link, via a technique known as “line combining.” The line combining can result in new, equivalent average headways and run time, but “TRNBUILD’s line-combining process combines only lines with the same mode.”<sup>21</sup> For this reason, and especially as COG/TPB staff transitions from TRNBUILD to Public Transport (PT), staff may choose to consolidate some of the current 10 mode codes into fewer mode code designations.

Table 3-20 provides additional detail about the transit services/providers/operators that are included in each of the ten modes.

---

<sup>21</sup> Citilabs, Inc., *Cube Voyager Reference Guide, Version 6.1.0* (Citilabs, Inc., April 24, 2013), 944.

**Table 3-20 Detailed equivalency of transit mode codes and transit operators**

Mode No.	Mode Description	Abbreviation/Prefix	Transit Service
1	Local Metrobus	"WM01 - 97, A - Z"	WMATA (DC, Alex., Falls Church, & MTG, PG, ARL, FFX Counties)
		"DC"	District of Columbia Circulator
2	Express Metrobus	"WM05 - 29"	WMATA (ARL, ALEX, FFX)
		"REX"	WMATA (FFX. Co.)
3	Metrorail	"WMRED"	RED Line
		"WMBLU"	BLUE Line
		"WMGRN"	GREEN Line
		"WMORN"	ORANGE Line
		"WMYEL"	YELLOW Line
		"WMSILV"	SILVER Line
4	Commuter Rail	"VFRED"	Frederick Line (VRE)
		"VMAS"	Manassas Line (VRE)
		"MBR"	Brunswick Line (MARC)
		"MCAM"	Camden Line (MARC)
		"MP"	Penn Line (MARC)
		"MFRED"	Frederick City Line (MARC)
		"AMTK"	AMTRAC Service
5	Light Rail	"PURLRT"	Purple Line -MTA (Bethesda -New Carrollton)
6	Other Primary - Local Bus	"ART"	Arlington County Bus
		"DAT"	City of Alexandria Bus
		"F"	Fairfax County Bus
		"GO"	Prince Georges County Bus
		"RO"	Montgomery Co. Ride On Bus
		"SG"	Fairfax City Bus
7	Other Primary - Express Bus	"TYSL"	Tyson's Circulator
		"DAT"	City of Alexandria Bus
8	Other Secondary - Local Bus	"F"	Fairfax County Bus
		"ANN"	City Of Annapolis Bus
		"CCATS"	Carroll County Bus
		"CC"	Calvert County Bus
		"FT"	Frederick County Bus
		"HT"	Howard County Bus
		"L"	City of Laurel Bus
		"LT"	Loudoun County Local Bus
		"OL"	OMNI-LINK (PrinceWilliam Co. Local)
		"VF"	Fredericksburg, Va ( VRE Bus)
9	Other Secondary - Express Bus	"VG"	Charles County Bus (VanGO)
		"ST"	St Mary's County Bus
		"LC"	Lee Coaches Commuter Bus
10	BRT/ Streetcar	"LCS"	Loudoun Co. Commuter Bus
		"LINK"	Washington Flyer- Dulles/WFC
		"MT"	Maryland MTA Bus (Frederick, Howard, Anne Arundel, Calvert, St Mary's, &Charles Counties)
		"OR"	OMNI-RIDE (Prince William Co. Commuter Bus)
		"PQ"	Quicks Commuter Bus (Fredericksburg, Spotsylvania & Stafford Counties)
		"SDC"	Nat'l Coach Commuter Bus (Fredericksburg, Spotsylvania & Stafford Co's)
		"MWAY"	US1 (Alexandria, Arlington) metroway BRT
"DCST"	DC Streetcar		
"US1BRT"	US1 (Fairfax) BRT		

Ref: " I:\ateam\docum\FY16\2015CLRP\_Network\_Report\NW\_Report\_Tables \Transit\_NetWrk\_Mode\_Codes.xlsx"

According to the rules of TRNBUILD, a transit path includes both transit and non-transit links. The transit links would include any movement on a transit vehicle, and these transit links would be categorized by the 10 transit modes previously mentioned. The non-transit links in a transit path are associated with accessing the transit service, transferring between transit services (especially those represented by different mode codes), and egressing from the transit service. In TRNBUILD vernacular, non-transit links are also called “support” links. Transit path-building and assignment are conducted in production/attraction format, so a transit path goes from a production zone to an attraction zone. At the production end of a transit trip, it is assumed that one will access the transit service via one of two modes: walking or driving. Walking includes biking. At the attraction end of a transit trip, it is assumed that there is only one egress mode: walking. This assumes that people do not egress from the transit system via car. Again, biking is considered part of walking. Also, transfers need to be made, such as from a rail station to a bus stop, and from a park-and-ride (PNR) lot to the associated transit stop. The five current mode codes use for these “non-transit” links are shown in Table 3-21.

**Table 3-21 Non-transit mode codes**

<b>Mode Code</b>	<b>Mode Description</b>
11	Drive-access to transit
12	Transfer link between rail and bus (walk)
13	Sidewalk link (walk)
14	(Unused)
15	Transfer link between park-and-ride (PNR) lot and transit stop (walk)
16	Walk access to/egress from transit

### 3.3.2 Rail Station File

The “station file” (station.dbf) contains information about Metrorail stations, commuter rail stations, light rail stations, bus rapid transit stations/stops, streetcar stations/stops, express-bus bus stops, and park-and-ride (PNR) lots that serve these stations/stops. The variables included in the station file are shown in Table 3-22.

As mentioned in the previous section, there are 10 transit mode codes and five non-transit mode codes. The station file uses its own “mode code,” which is a letter, instead of a number, as shown in Table 3-22. The station file also includes an access distance code (“NCT”), which controls the number, extent, and directionality of PNR/KNR access links generated for each parking lot. The acceptable values for the access distance code are shown in Table 3-23.

**Table 3-22 Variables in the transit station file (Station.dbf)**

Name	Type	Field Description
SEQNO	N	Sequence Number
MM	C	Mode Code (M=Metrorail, C=Commuter rail, B=Bus, L=Light rail, N= BRT/streetcar)
NCT	N	Access distance code (1, 2, 3, 0, 9, 8) (See Table 3-23)
STAPARK	C	Does the station have a park-and-ride lot? (Y=yes; blank=no)
STAUSE	C	Is the station in use for the given year? (Y=yes; blank=no)
SNAME	C	Station Name/PNR lot name
STAC	N	Station centroid number (5001-7999), also known as a park-and-ride (PNR) lot centroid or a dummy PNR centroid"
STAZ	N	For the purposes of path building, the TAZ (1-3722) that represents the location of the station PNR lot. Usually the closest TAZ to the PNR lot.
STAT	N	Station Node (8000-8999, 9000-9999, 10000-10999)
STAP	N	Station park-and-ride (PNR) node number (11000-13999)
STAN1	N	Station bus node #1 (used to generate a station-to-bus-node connector)
STAN2	N	Station bus node #2 (used to generate a station-to-bus-node connector)
STAN3	N	Station bus node #3 (used to generate a station-to-bus-node connector)
STAN4	N	Station bus node #4 (used to generate a station-to-bus-node connector)
STAPCAP	N	Parking capacity (number of spaces at the PNR lot)
STAX	N	X coordinate of station/PNR lot (MD State Plane, NAD83, feet)
STAY	N	Y coordinate of station/PNR lot (MD State Plane, NAD83, feet)
STAPKCOST	N	Peak period parking cost (daily cost, cents)
STAOPCOST	N	Off-peak parking cost (hourly cost, cents)
STAPKSHAD	N	Peak-period shadow price ( <b>currently not used</b> )
STAOPSHAD	N	Off-peak-period shadow price ( <b>currently not used</b> )
FIRSTYR	N	Year of Station/PNR lot Opening (unused by scripts, but used as metadata)
STA_CEND	N	Project ID (Metadata)
	C	Scenario name, or left blank (Metadata)
	C	Comments, if any, regarding the file, since file cannot accept comment lines preceding the data lines

Notes: The SEQNO variable does not correspond to the station node (STAT), and, unlike the STAT, cannot be assumed to stay the same over time.

Source: Jain, M. (2010, October). MWCOG network coding guide for Nested Logit Model (First draft: September 20, 2007; Updated February 2008 and October 2010). Memorandum.

**Table 3-23 Transit access distance codes (NCT)**

Access Dist. Code	Interpretation
1	End-of-the-line station (e.g., Shady Grove Metro)
2	Intermediate station (e.g., Rockville Metro)
3	PNR close to a CBD (e.g., Rhode Island Ave. Metro, Fort Totten)
0	Only KNR-access links generated (e.g., Braddock Road, National Airport, Clarendon)
9	Metrorail sta. in use, but no PNR/KNR access (e.g., Dupont Circle, Farragut North, Metro Ctr.)
8	Pentagon Metro Sta., allows for very long KNR links, to represent "slugging" (informal carpool)

Table 3-24 shows the designated ranges for station centroids and station nodes associated with Metrorail, commuter rail, LRT, and BRT/streetcar.

**Table 3-24 Station centroid and station node range by mode**

Mode	Mode Code	Station Centroid Range	Station Node Range
Metrorail (Mode 3)	M	5000-5999	8000-8999
Commuter rail (Mode 4)	C	6000-6999	9000-9999
Light rail transit (Mode 5)	L	Not used	10000-10499
Bus rapid transit/streetcar (Mode 10)	N	Not used	10500-10999
Bus (Modes 1, 2, 6-9)	B	Not used	Not used

### 3.3.3 Walk- and Drive-Access to Transit

As stated earlier, transit path-building and assignment are conducted in production/attraction format, so a transit path is constructed from a production zone to an attraction zone. At the production end of a transit trip, it is assumed that one will access the transit service via one of two modes: walking or driving. Walking includes biking. At the attraction end of a transit trip, it is assumed that there is only one egress mode: walking. This assumes that people do not egress from the transit system via car.

A series of Cube Voyager scripts are used as part of the transit network building process to enable automatic generation of transit access and transfer links, including zonal walk access links, PNR lot-to-rail station links, and auto access links (TAZ-to-station links). These are non-transit modes that are used to access transit and transfer between transit services and have transit mode codes of 11-16 as shown in Table 3-21. Further details can be found in Chapter 22 of the Version 2.3.57a model User’s Guide, which discusses the automatic generation of transit access, auto-access links, and walk-access links.

As shown in Figure 3-15, there are three Cube Voyager scripts that are used for developing access links:

- WALKACC.S: Used to develop zonal walk-access links
- AUTOACC4.S: Used to generate zonal drive-access links
- PARKER.S: Used to generate walk connections between PNR lots and rail stations

Figure 3-15 Process for developing walk-access and drive-access links

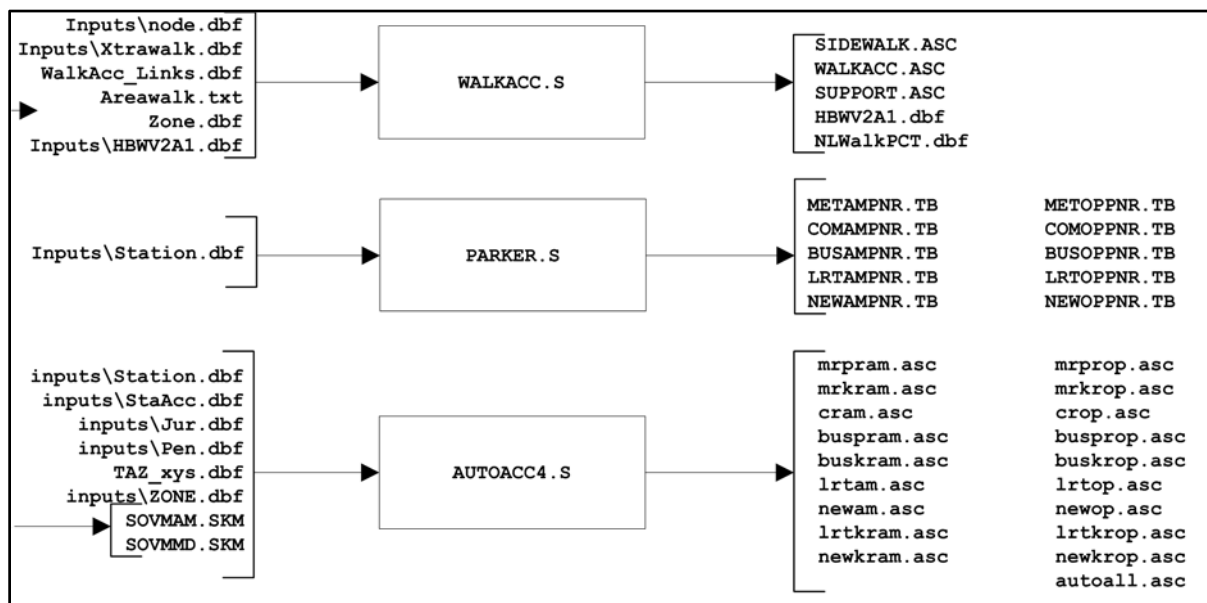

As noted in the Version 2.3.57a Travel Model user's guide, the automated approach for generating these links has greatly streamlined the transit network coding process. All three of these programs were originally developed as stand-alone Fortran programs developed by AECOM Consult. TPB staff converted these three Fortran programs to Cube Voyager scripts.

WALKACC.S requires the following input files:

- Node.dbf: A file with the X and Y coordinates of all the transit stop nodes
- Xtrawalk.dbf: A file with extra/user-specified walk links, which can be used in cases where the background highway network lacks sufficient detail to provide adequate walk access (it is assumed that one can walk on all highway links, except freeways, expressways, and ramps).
- WalkAcc\_Links.dbf: A list of highway links that can be used for generating walk-access links (developed by MODNET.S)
- Areawalk.txt: A file containing information needed to calculate the zonal percent-walk-to-transit (PWT) values. An excerpt from this file can be found in Figure 3-16. This file contains the following variables:
  - **TAZID**: TAZ number.
  - **TAZAREA**: Area of the TAZ in square miles.
  - **MTLRTSHR**: Area of the TAZ (sq. mi.) within a short (0.5 mile) walk of Metrorail or LRT service
  - **MTLRTLNG**: Area of the TAZ (sq. mi.) within a long (1.0 mile) walk of Metrorail or LRT service
  - **ALLPKSHR**: Area of the TAZ (sq. mi.) within a short (0.5 mile) walk of any transit service (including Metrorail and LRT) in the AM peak period

- **ALLPKLNG**: Area of the TAZ (sq. mi.) within a long (1 mile) walk of any transit service (including Metrorail and LRT) in the AM peak period
- **ALLOPSHR**: Area of the TAZ (sq. mi.) within a short (0.5 mile) walk of any transit service (including Metrorail and LRT) in the **off-peak** period
- **ALLOPLNG**: Area of the TAZ (sq. mi.) within a long (1 mile) walk of any transit service (including Metrorail and LRT) in the **off-peak** period
- Zone.dbf: Standard zonal attribute input file.
- HBWV2A1.dbf: A file with zonal information that is both created by WALKACC.S and then later read into WALKACC.S.

This file need not be sorted by TAZ (as can be seen in Figure 3-16).

**Figure 3-16 An excerpt from the AreaWalk.txt file**

TAZID	TAZ_AREA	MTLRTSHR	MTLRTLNG	ALLPKSHR	ALLPKLNG	ALLOPSHR	ALLOPLNG
2633	0.0540	0.0000	0.0000	0.0540	0.0540	0.0540	0.0540
2634	0.1897	0.0000	0.0000	0.1897	0.1897	0.1897	0.1897
2635	0.6364	0.0000	0.0000	0.4804	0.6364	0.4804	0.6364
2636	0.4917	0.0000	0.0000	0.4917	0.4917	0.4917	0.4917
2637	1.2188	0.0000	0.0000	1.2188	1.2188	1.1620	1.2188
2638	0.6354	0.0000	0.0000	0.4923	0.6354	0.5544	0.6354
2639	0.6991	0.0000	0.0000	0.4743	0.6991	0.4743	0.6991
2640	0.0593	0.0000	0.0000	0.0593	0.0593	0.0593	0.0593
259	0.6207	0.3757	0.6183	0.4934	0.6207	0.4891	0.6207
260	0.4965	0.0000	0.0303	0.4232	0.4965	0.4232	0.4965
1788	1.4192	0.0000	0.0000	0.5475	1.1463	0.5475	1.1463
1789	0.2863	0.0000	0.0412	0.2863	0.2863	0.2863	0.2863
1790	0.3237	0.0000	0.0537	0.3237	0.3237	0.3237	0.3237
1791	0.2910	0.0000	0.0000	0.2661	0.2910	0.2661	0.2910
1792	0.1824	0.0000	0.0029	0.1824	0.1824	0.1824	0.1824
1793	0.1622	0.0000	0.0000	0.1622	0.1622	0.1622	0.1622
1794	0.1026	0.0000	0.0000	0.1026	0.1026	0.1026	0.1026
1795	0.1574	0.0000	0.0000	0.1574	0.1574	0.1574	0.1574
1796	0.9296	0.0000	0.0000	0.9296	0.9296	0.9296	0.9296
1797	0.3545	0.0000	0.0000	0.3545	0.3545	0.3545	0.3545
1798	0.9034	0.0000	0.0083	0.8868	0.9034	0.8868	0.9034
1799	0.3016	0.0000	0.0000	0.3012	0.3016	0.3012	0.3016

The principal output files from WalkAcc.S are

- sidewalk.asc: Sidewalk links.
- walkacc.asc: Walk-access/walk-egress links.
- support.asc: Non-transit/support links.



Figure 3-17 shows walk access/egress links (mode 16) in TAZ 56, which is east of Foggy Bottom Metrorail Station. The thick, dark blue links, in the star-burst shape, are the walk access/egress links for one zone (TAZ 56). The thin, dark blue segments are road links. The red links are transit-only links, and the thick, light blue and green links are the Metrorail links (Metrorail's Orange/Blue Line).

**Figure 3-17 Walk access/egress links in TAZ 56, east of Foggy Bottom Metrorail Station**

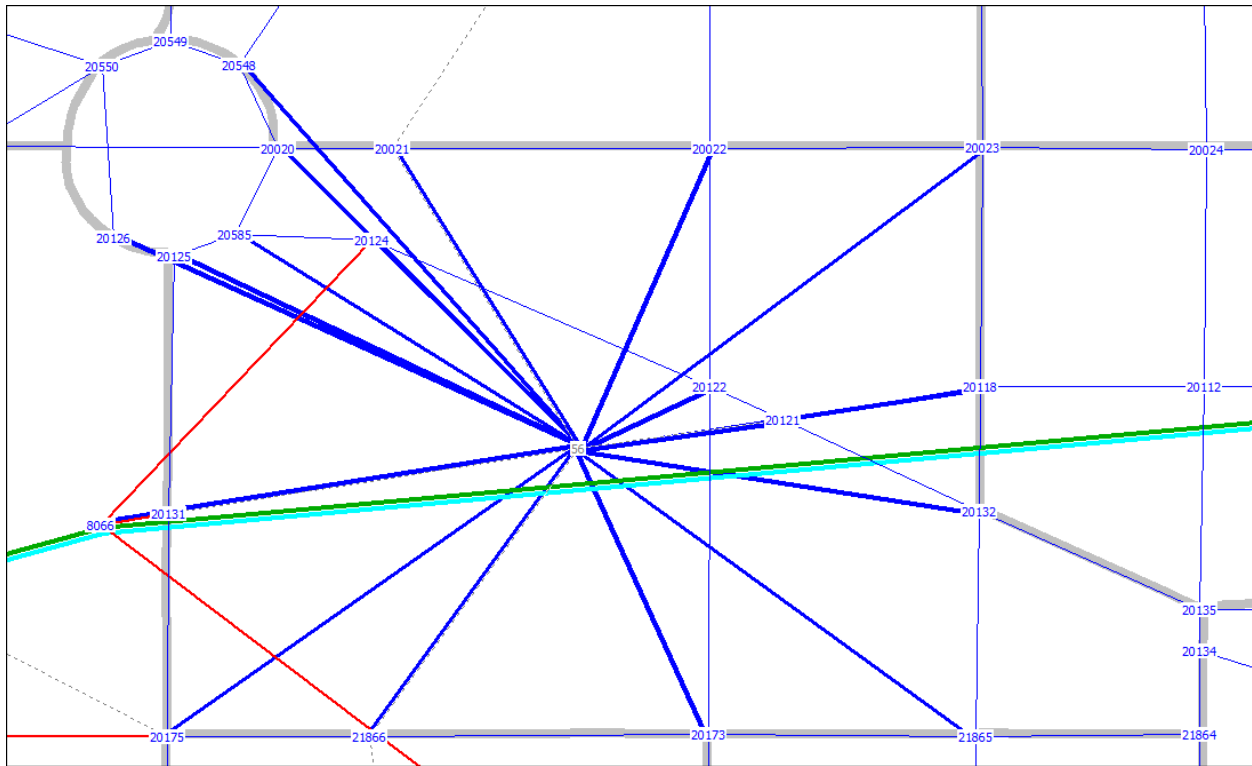

Ref: "L:\modelRuns\fy14\Ver2.3.52\_Conformity2013CLRP\_Xmittal\2010\_Final\zonehwy.net"; "support\_mode16\_taz56.asc"  
"MODE3AM.TB"

AutoAcc4.s requires the eight input files shown in Figure 3-15. Figure 3-18 shows an example of the drive-access links (mode 11) associated with the Ballston Metrorail Station park-and-ride (PNR) lot. The lot is located just to the south of the station, which appears as a black dot on the orange line representing Metrorail's Orange Line. Notice that the star-burst shape of the auto access links is not a simple circle, but rather has a directional orientation, reflecting the fact the people have less tendency to back-track when looking for parking at the production end of their trip.

Figure 3-18 Drive-access links associated with the Ballston Metrorail Station PNR lot



Ref: "L:\modelRuns\fy14\Ver2.3.52\_Conformity2013CLRP\_Xmittal\2010\_Final\zonehwy.net"; "MODE3AM.TB"  
"auto\_all\_ballston\_knr.asc" "auto\_all\_ballston\_pnr.asc" "support.asc"

### 3.3.4 Station Coordinate Files

The files in Table 3-18 that end with “\_node.tb” are the station coordinate files:

- Met\_node.tb: Metrorail stations
- Com\_node.tb: Commuter rail stations
- LRT\_node.tb: LRT stations/stops
- New\_node.tb: BRT and/or streetcar stations/stops

These files come directly from the geodatabase. The file extension of “TB” indicates “TRNBUILD” and was introduced by COG/TPB staff a number of years ago to differentiate the files from those formatted for the previous transit path builder, TRNPTH (“TP”). An excerpt from the Metrorail station coordinate file (met\_node.tb) can be seen in Figure 3-19. Coordinates are Maryland State Plane, NAD 1983, in feet.

**Figure 3-19 Excerpt from the Metrorail station coordinate file (met\_node.tb)**

XY NODE=	8001	X=	1265599	Y=	529193	;;Shady Grove
XY NODE=	8002	X=	1270639	Y=	516540	;;Rockville
XY NODE=	8003	X=	1278225	Y=	508218	;;Twinbrook
XY NODE=	8004	X=	1280517	Y=	503088	;;White Flint
XY NODE=	8005	X=	1282829	Y=	496367	;;Grosvenor
XY NODE=	8006	X=	1284767	Y=	485106	;;Medical Center
XY NODE=	8007	X=	1285560	Y=	479782	;;Bethesda
XY NODE=	8008	X=	1288003	Y=	471196	;;Friendship Heights
XY NODE=	8009	X=	1289640	Y=	466682	;;Tenleytown
XY NODE=	8010	X=	1294409	Y=	464951	;;Van Ness-UDC
XY NODE=	8011	X=	1295608	Y=	462324	;;Cleveland Park
XY NODE=	8012	X=	1297352	Y=	458473	;;Woodley Park-Zoo
XY NODE=	8013	X=	1299822	Y=	453020	;;Dupont Circle
XY NODE=	8014	X=	1301030	Y=	450307	;;Farragut North
XY NODE=	8015	X=	1304332	Y=	448558	;;Metro Center
XY NODE=	8016	X=	1306089	Y=	448606	;;Gallery Place
XY NODE=	8017	X=	1307581	Y=	447814	;;Judiciary Square
XY NODE=	8018	X=	1310220	Y=	448408	;;Union Station
XY NODE=	8019	X=	1313230	Y=	456638	;;Rhode Island Ave
XY NODE=	8020	X=	1313751	Y=	461393	;;Brookland-CUA
XY NODE=	8021	X=	1311788	Y=	467989	;;Fort Totten
XY NODE=	8022	X=	1307186	Y=	476758	;;Takoma

### 3.3.5 Transit Parking Lot Coordinate Files

The files in Table 3-18 that end with “\_pnrn.tb” are the transit parking lot coordinate files:

- met\_pnrn.tb: Metrorail PNR lot coordinates
- com\_pnrn.tb: Commuter rail PNR lot coordinates
- bus\_pnrn.tb: Bus PNR lot coordinates

- lrt\_pnrn.tb: LRT PNR lot coordinates
- new\_pnrn.tb: BRT and/or streetcar PNR lot coordinates

An excerpt from the Metrorail PNR lot coordinate file (met\_pnrn.tb) can be seen in Figure 3-20. Coordinates are Maryland State Plane, NAD 1983, in feet.

**Figure 3-20 An excerpt of the Metrorail PNR lot coordinate file (met\_pnrn.tb)**

XY	NODE=	11001	X=	1265315	Y=	529089	;;Shady Grove
XY	NODE=	11002	X=	1270959	Y=	516684	;;Rockville
XY	NODE=	11003	X=	1278613	Y=	508435	;;Twinbrook
XY	NODE=	11004	X=	1281327	Y=	503024	;;White Flint
XY	NODE=	11005	X=	1283249	Y=	496139	;;Grosvenor
XY	NODE=	11007	X=	1285562	Y=	479783	;;Bethesda
XY	NODE=	11019	X=	1313784	Y=	456689	;;Rhode Island Ave
XY	NODE=	11021	X=	1311284	Y=	468649	;;Fort Totten
XY	NODE=	11023	X=	1303903	Y=	483450	;;Silver Spring
XY	NODE=	11024	X=	1299517	Y=	491425	;;Forest Glen
XY	NODE=	11025	X=	1297560	Y=	499796	;;Wheaton
XY	NODE=	11026	X=	1297615	Y=	508431	;;Glenmont
XY	NODE=	11027	X=	1338527	Y=	489633	;;Greenbelt
XY	NODE=	11028	X=	1332678	Y=	476884	;;College Park
XY	NODE=	11029	X=	1324845	Y=	472917	;;PG Plaza
XY	NODE=	11030	X=	1321380	Y=	469383	;;West Hyattsville
XY	NODE=	11040	X=	1313758	Y=	436270	;;Anacostia
XY	NODE=	11042	X=	1319454	Y=	427220	;;Southern Avenue

### 3.3.6 Rail Links

The files in Table 3-18 that end with “\_link.tb” are the rail link files:

- met\_link.tb
- com\_link.tb
- lrt\_link.tb
- new\_link.tb

An excerpt of the Metrorail rail link file (met\_link.tb) is shown in Figure 3-21. The first record of the file is for the rail link (tracks) between Shady Grove Metrorail Station (8001) and Rockville Metrorail Station (8002). Metrorail is mode code 3 and this segment of track has a distance of 2.61 miles. The speed coded for each rail link is a function of the rail link distance.

Figure 3-21 An excerpt of the Metrorail rail link file (met\_link.tb)

LINK	NODES=	8001-	8002	MODES=	03	DIST=	261	ONEWAY=	N	SPEED=	40.05
LINK	NODES=	8002-	8003	MODES=	03	DIST=	213	ONEWAY=	N	SPEED=	40.20
LINK	NODES=	8003-	8004	MODES=	03	DIST=	109	ONEWAY=	N	SPEED=	22.00
LINK	NODES=	8004-	8005	MODES=	03	DIST=	135	ONEWAY=	N	SPEED=	41.40
LINK	NODES=	8005-	8006	MODES=	03	DIST=	219	ONEWAY=	N	SPEED=	44.60
LINK	NODES=	8006-	8007	MODES=	03	DIST=	102	ONEWAY=	N	SPEED=	31.50
LINK	NODES=	8007-	8008	MODES=	03	DIST=	170	ONEWAY=	N	SPEED=	34.40
LINK	NODES=	8008-	8009	MODES=	03	DIST=	91	ONEWAY=	N	SPEED=	23.40
LINK	NODES=	8009-	8010	MODES=	03	DIST=	109	ONEWAY=	N	SPEED=	33.30
LINK	NODES=	8010-	8011	MODES=	03	DIST=	55	ONEWAY=	N	SPEED=	18.90
LINK	NODES=	8011-	8012	MODES=	03	DIST=	80	ONEWAY=	N	SPEED=	21.30
LINK	NODES=	8012-	8013	MODES=	03	DIST=	115	ONEWAY=	N	SPEED=	35.70
LINK	NODES=	8013-	8014	MODES=	03	DIST=	56	ONEWAY=	N	SPEED=	15.30
LINK	NODES=	8014-	8015	MODES=	03	DIST=	79	ONEWAY=	N	SPEED=	22.20
LINK	NODES=	8015-	8016	MODES=	03	DIST=	33	ONEWAY=	N	SPEED=	17.40
LINK	NODES=	8015-	8068	MODES=	03	DIST=	46	ONEWAY=	N	SPEED=	24.60

### 3.3.7 Transfer Links

Non-transit links, or support links, include links to access the transit system, to egress from the transit system, and to transfer between transit routes. Transfer links are used to transfer between a rail mode (mode codes 3, 4, 5, and 10) and a non-rail mode (mode codes 1, 2, 6, 7, 8, and 9), such as from Metrorail to bus. Under current coding conventions, these rail-to-non-rail transit transfer links are designated mode code 12. There are four transfer link files:

- met\_bus.tb
- com\_bus.tb
- lrt\_bus.tb
- new\_bus.tb

An excerpt from the file containing transfer links between Metrorail stations and bus stops is shown in Figure 3-22.

**Figure 3-22 An excerpt from the file (met\_bus.tb) containing transfer links (mode 12) between Metrorail stations and bus stops**

SUPPORT N=	8001-	22395	ONEWAY=	N	MODES=	12	DIST =	1	SPEED =	3
SUPPORT N=	8001-	22397	ONEWAY=	N	MODES=	12	DIST =	1	SPEED =	3
SUPPORT N=	8002-	9005	ONEWAY=	N	MODES=	12	DIST =	1	SPEED =	3
SUPPORT N=	8002-	22351	ONEWAY=	N	MODES=	12	DIST =	1	SPEED =	3
SUPPORT N=	8002-	22370	ONEWAY=	N	MODES=	12	DIST =	1	SPEED =	3
SUPPORT N=	8003-	22344	ONEWAY=	N	MODES=	12	DIST =	1	SPEED =	3
SUPPORT N=	8003-	22672	ONEWAY=	N	MODES=	12	DIST =	1	SPEED =	3
SUPPORT N=	8004-	22332	ONEWAY=	N	MODES=	12	DIST =	1	SPEED =	3
SUPPORT N=	8004-	22670	ONEWAY=	N	MODES=	12	DIST =	1	SPEED =	3
SUPPORT N=	8005-	22327	ONEWAY=	N	MODES=	12	DIST =	1	SPEED =	3
SUPPORT N=	8006-	22054	ONEWAY=	N	MODES=	12	DIST =	1	SPEED =	3
SUPPORT N=	8007-	22048	ONEWAY=	N	MODES=	12	DIST =	1	SPEED =	3
SUPPORT N=	8008-	22864	ONEWAY=	N	MODES=	12	DIST =	1	SPEED =	3
SUPPORT N=	8009-	20718	ONEWAY=	N	MODES=	12	DIST =	1	SPEED =	3
SUPPORT N=	8010-	20753	ONEWAY=	N	MODES=	12	DIST =	1	SPEED =	3
SUPPORT N=	8011-	20756	ONEWAY=	N	MODES=	12	DIST =	1	SPEED =	3
SUPPORT N=	8012-	20763	ONEWAY=	N	MODES=	12	DIST =	1	SPEED =	3
SUPPORT N=	8013-	20503	ONEWAY=	N	MODES=	12	DIST =	1	SPEED =	3

The station file, mentioned earlier, contains up to four “bus” nodes for each rail station. “Bus node” actually means any transit node near the rail station that should be connected with the rail station. So, for example, for the Rockville Metrorail Station (8002), the first “bus” node (STAN1) is 9005, which is not a bus stop, but rather a commuter rail station (the Rockville MARC station). The pairing of each rail station and its associated “bus” nodes forms the transfer links that are found in the transfer link files.

### 3.3.8 Transit Line/Route Files

The AM Peak and Off-Peak transit line files are text files that contain operational information about individual transit lines/routes, including the average headway (frequency) for the time period, the average scheduled running time for the time period, and the route itinerary, which are the nodes through which the transit passes. Transit routes can be designated one-way or two-way. Figure 3-23 shows an example of a transit line file in TRNBUILD format for Mode 1 (local bus: Metrobus and DC Connector). The TPB transit networks currently designate ten mode codes as listed in Table 3-19 and Table 3-20.



**Table 3-25 Header section for each transit route in a transit line file**

File Name	Variable Name	Description
<b>Mode&lt;No. &gt;&lt;per&gt;.tb</b>	LINE NAME	Abbreviation of transit service provider name
	OWNER	The OWNER variable is currently being used to store five fields, which are separated by semicolons: <ol style="list-style-type: none"> <li>1. Transit operator</li> <li>2. Origin</li> <li>3. Destination</li> <li>4. Year represented</li> <li>5. Scenario</li> </ol>
	ONEWAY	Y/N (Y= Yes and N=No)
	MODE	Transit mode codes (1 - 10)
	FREQ[1]	Average time between successive arrivals (or departures) of transit vehicles on a given route for the period (AM or OP). Also known as average headway.
	RUNTIME	Average time (in min) for the transit vehicle to go from the start to the finish of its route, for the given period (AM or OP)

**Key:** <No.> 1-10  
 <per> = AM (AM peak period) or OP (off-peak period), see pp. 2-3 to 2-4.

After the route header information, there is a node itinerary, which is a list through which the route passes.

The file extension of “TB” in the names of the line files (also sometimes called “mode files”) indicates “TRNBUILD” and was introduced by COG/TPB staff a number of years ago to differentiate the files from those formatted for the previous transit path builder, TRNPTH (“TP”). A more standard file extension for these types of files is “LIN,” which stands for transit line/route.

### 3.3.9 Example of network coding

Figure 3-24 shows a diagram that illustrates the existing MWCOC/TRNBUILD convention for network coding around rail stations (Metro or commuter rail), park-and-ride lots, and bus service.



Figure 3-24 Existing MWCOC/TRNBUILD convention for network coding around rail stations, park-and-ride lots, and bus service

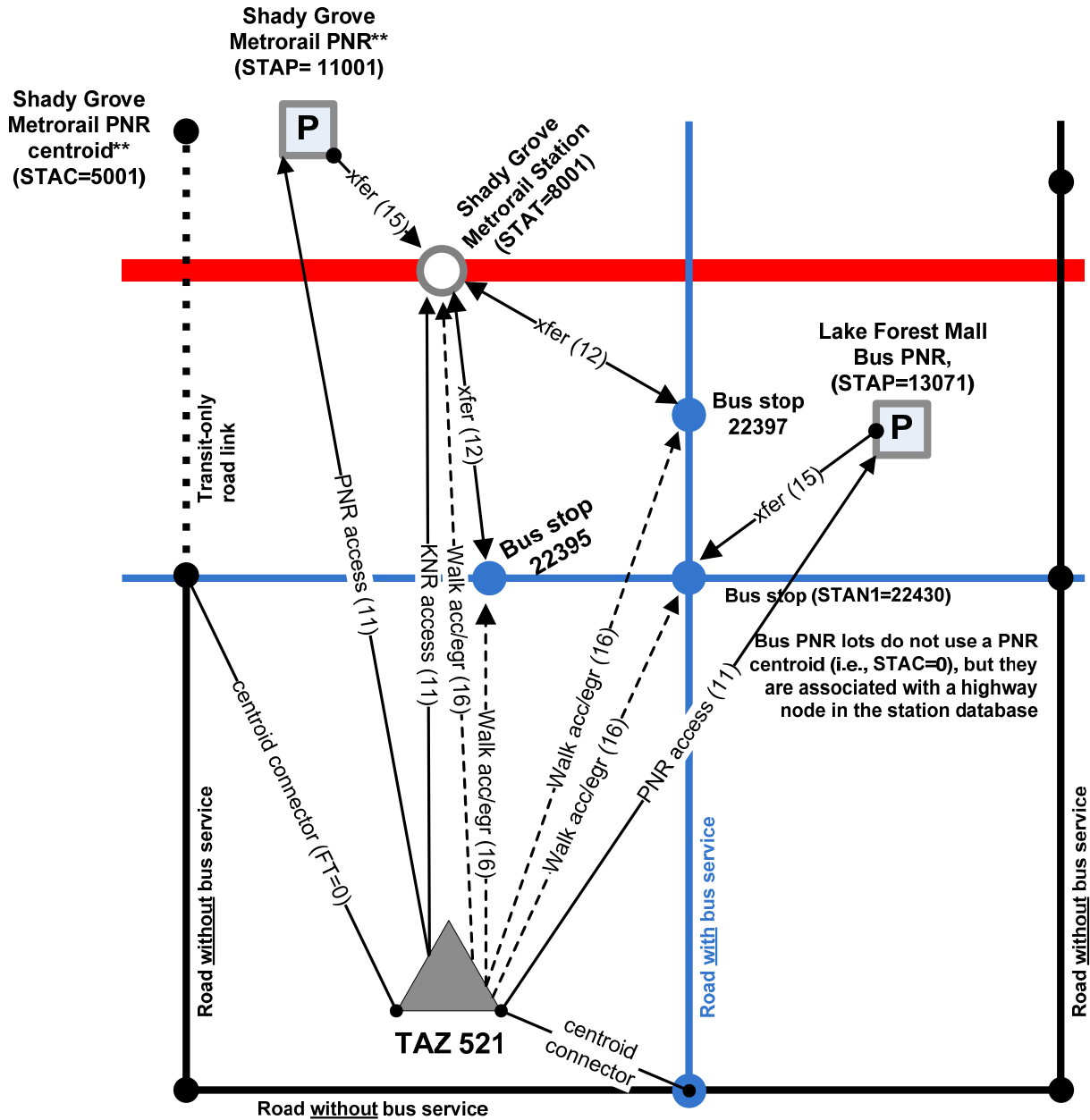

Ref: "I:\ateam\docum\fy14\2013CLRP\_Network\_Report\network\_coding\_station\_diagr\_mwcog\_trnbuild.vsd"

In Figure 3-24, numbers in parentheses are mode codes. For example, mode code 11 is drive access to transit, which can be either drive and park (PNR) or drive and drop off ("kiss and ride," KNR). Mode code 16 is for walk access or egress links. Two types of transfer links are shown in the diagram:

- Mode 12: Transfer between a rail mode and a non-rail transit mode (walk)
- Mode 15: Transfer between a PNR lot and the rail station (walk)

Also, the PNR node and the dummy PNR node are stored in the background highway network.

### **3.3.10 Transit route summaries**

This section of the report presents a number of transit route summaries. The highway and transit networks discussed in this report are based on the 2015 CLRP and FY 2015-2020 TIP. The 2015 CLRP and FY 2015-2020 TIP were also the basis for the networks used in the most recent air quality conformity analysis,<sup>22</sup> which was approved by the TPB on October 21, 2015. The analysis years for the air quality conformity work were 2015, 2017, 2020, 2025, 2030 and 2040. Additionally, the base year for updating the transit information in the transit networks was 2014. Specifically, transit service was based on schedule information obtained in the fall/winter of 2014, and transit projects in the 2015 CLRP were added to the transit network for each appropriate forecast year. Thus, the years included in this report are: 2015, 2017, 2020, 2025, 2030 and 2040.

Summaries of the AM peak period Metrorail routes are shown in Table 3-26. Note that Table 3-26 does not show data for 2030 and 2040, since the Metrorail data for these two years was actually the same as that for 2025 (so only 2025 is shown in the Metrorail tables). The table lists COG/TPB's transit route name, origin and destination stations, average headways, average run-times, line distances, and average line speed for service during the AM peak hour and Off-peak period. Table 3-27 presents the same information, but for the off-peak period. Note that the Red Line has two different routes:

- Red Line A: From Shady Grove (end of the line) to Glenmont (end of the line)
- Red Line B: From Grosvenor to Silver Spring

This is reflected in the route names, e.g., Red-A and Red-B. Note: Some routes are denoted "A" even though there is only one of them, such as Green Line A ("Grn-A").

---

<sup>22</sup> *Air Quality Conformity Determination of the 2015 Constrained Long-Range Plan and the FY 2015-2020 Transportation Improvement Program for the Washington Metropolitan Region.*

**Table 3-26 AM peak-period Metrorail line summary by year: 2015, 2017, 2020, and 2025**

Transit Route Name	Transit Yr.	Origin	Destination	Hdwy	RT (mins.)	Dist. (mi)	Spd (mph)
WMBLUA	2015	FRANCONIA/SPRINGFIELD	LARGO TWN CTR	12	64	30	28
WMYELB	2015	FRANCONIA/SPRINGFIELD	GREENBELT	12	58	29	30
WMGRNA	2015	GREENBELT	BRANCH AVE	6	47	23	29
WMSILV	2015	WIEHLE	LARGO TOWN CENTER	6	75	32	26
WMORNA	2015	VIENNA	NEW CARROLLTON	6	57	26	27
WMREDA	2015	SHADY GROVE METRO	GLENMONT METRO	6	65	32	30
WMREDB	2015	SILVER SPRING METRO	GROSVENOR METRO	6	44	19	26
WMYELA	2015	MT VERNON SQ/7TH ST-CONVENTION	HUNTINGTON AV METRO	6	25	10	24
WMBLUA	2017	FRANCONIA/SPRINGFIELD	LARGO TWN CTR	12	64	30	28
WMYELB	2017	FRANCONIA/SPRINGFIELD	GREENBELT	12	58	29	30
WMGRNA	2017	GREENBELT	BRANCH AVE	6	47	23	29
WMORNA	2017	VIENNA	NEW CARROLLTON	6	57	26	27
WMREDA	2017	SHADY GROVE METRO	GLENMONT METRO	6	65	32	30
WMREDB	2017	SILVER SPRING METRO	GROSVENOR METRO	6	44	19	26
WMYELA	2017	MT VERNON SQ/7TH ST-CONVENTION	HUNTINGTON AV METRO	6	25	10	24
WMSILV	2017	VA 772	LARGO	6	90	43	29
WMBLUA	2020	FRANCONIA/SPRINGFIELD	LARGO TWN CTR	12	64	30	28
WMYELB	2020	FRANCONIA/SPRINGFIELD	GREENBELT	12	58	29	30
WMGRNA	2020	GREENBELT	BRANCH AVE	6	47	23	29
WMORNA	2020	VIENNA	NEW CARROLLTON	6	57	26	27
WMREDA	2020	SHADY GROVE METRO	GLENMONT METRO	6	65	32	30
WMREDB	2020	SILVER SPRING METRO	GROSVENOR METRO	6	44	19	26
WMYELA	2020	MT VERNON SQ/7TH ST-CONVENTION	HUNTINGTON AV METRO	6	25	10	24
WMSILV	2020	VA 772	LARGO	6	90	43	29
WMBLUA	2025	FRANCONIA/SPRINGFIELD	LARGO TWN CTR	12	66	30	27
WMYELB	2025	FRANCONIA/SPRINGFIELD	GREENBELT	12	60	29	29
WMGRNA	2025	GREENBELT	BRANCH AVE	6	47	23	29
WMORNA	2025	VIENNA	NEW CARROLLTON	6	57	26	27
WMREDA	2025	SHADY GROVE METRO	GLENMONT METRO	6	65	32	30
WMREDB	2025	SILVER SPRING METRO	GROSVENOR METRO	6	44	19	26
WMYELA	2025	MT VERNON SQ/7TH ST-CONVENTION	HUNTINGTON AV METRO	6	27	11	24
WMSILV	2025	VA 772	LARGO	6	90	43	29

**Note:** AM peak period is from 7:00 – 7:59 AM. Years 2030 and 2040 Metrorail data is the same as 2025.

Ref: "I:\ateam\docum\FY16\2015CLRP\_Network\_Report\NW\_Report\_Tables\CLRP\_2015\_Met\_Com\_BRT\_Files.xlsx"

Source: 2015 CLRP and FY2015-2020 TIP

**Table 3-27 Off-peak period Metrorail line summary by year: 2015, 2017, 2020, and 2025**

Transit Route Name	Transit Yr.	Origin	Destination	Hdwy	RT (mins.)	Dist. (mi)	Spd (mph)
WMBLUA	2015	FRANCONIA/SPRINGFIELD	LARGO TWN CTR	12	64	30	28
WMGRNA	2015	GREENBELT	BRANCH AVE	12	47	23	29
WMSILV	2015	WIEHLE	LARGO TOWN CENTER	12	75	32	26
WMORNA	2015	VIENNA	NEW CARROLLTON	12	57	26	27
WMREDB	2015	SILVER SPRING METRO	GROSVENOR METRO	12	43	19	27
WMYELA	2015	FT TOTTEN	HUNTINGTON	12	36	15	25
WMREDA	2015	SHADY GROVE METRO	GLENMONT METRO	12	63	32	30
WMBLUA	2017	FRANCONIA/SPRINGFIELD	LARGO TWN CTR	12	64	30	28
WMGRNA	2017	GREENBELT	BRANCH AVE	12	47	23	29
WMORNA	2017	VIENNA	NEW CARROLLTON	12	57	26	27
WMREDB	2017	SILVER SPRING METRO	GROSVENOR METRO	12	43	19	27
WMYELA	2017	FT TOTTEN	HUNTINGTON	12	36	15	25
WMSILV	2017	VA 772	LARGO	12	90	43	29
WMREDA	2017	SHADY GROVE METRO	GLENMONT METRO	12	63	32	30
WMBLUA	2020	FRANCONIA/SPRINGFIELD	LARGO TWN CTR	12	64	30	28
WMGRNA	2020	GREENBELT	BRANCH AVE	12	47	23	29
WMORNA	2020	VIENNA	NEW CARROLLTON	12	57	26	27
WMREDB	2020	SILVER SPRING METRO	GROSVENOR METRO	12	43	19	27
WMYELA	2020	FT TOTTEN	HUNTINGTON	12	36	15	25
WMSILV	2020	VA 772	LARGO	12	90	43	29
WMREDA	2020	SHADY GROVE METRO	GLENMONT METRO	12	63	32	30
WMBLUA	2025	FRANCONIA/SPRINGFIELD	LARGO TWN CTR	12	66	30	27
WMGRNA	2025	GREENBELT	BRANCH AVE	12	47	23	29
WMORNA	2025	VIENNA	NEW CARROLLTON	12	57	26	27
WMREDB	2025	SILVER SPRING METRO	GROSVENOR METRO	12	43	19	27
WMYELA	2025	FT TOTTEN	HUNTINGTON	12	38	15	24
WMSILV	2025	VA 772	LARGO	12	90	43	29
WMREDA	2025	SHADY GROVE METRO	GLENMONT METRO	12	63	32	30

**Note:** Off-peak period is from 10:00 AM- 2:59 PM

Ref: "I:\ateam\docum\FY16\2015CLRP\_Network\_Report\NW\_Report\_Tables\CLRP\_2015\_Met\_Com\_BRT\_Files.xlsx"  
 Source: 2015 CLRP and FY2015-2020 TIP

Line summaries for commuter rail are shown in Table 3-28 and Table 3-30. Table 3-28 covers the AM peak period and Table 3-30 covers the off-peak period for years 2015, 2017, 2020, 2025 and 2030 (and implicitly 2040, since this year is the same as 2030). Line summaries for light rail and BRT/ Streetcar are shown in Table 3-31 and Table 3-32. Table 3-32 covers the off-peak period summaries for the years 2015, 2017, 2020, 2025, and 2030 (and implicitly 2040, since this year is the same as 2030).

**Table 3-28 AM peak-period commuter rail summary by year: 2015, 2017, and 2020**

Transit Route Name	Transit Year	Origin	Destination	Hdwy	RT(mins.)	Dis.(mi)	Spd(mph)
AMTK86I	2015	Spotsylvania	UNION STATION VRE	60	85	60	42
MBR876	2015	BRUNSWICK STATION	UNION STATION	60	95	50	32
MBR878	2015	Duffields WVA	Union Station	60	111	62	34
MCAM847	2015	DORSEY	UNION STATION	60	54	25	28
MCAM840	2015	UNION STATION	DORSEY	60	47	25	32
MP409	2015	BWI	UNION STATION	60	36	30	50
MP407511	2015	BWI	UNION STATION	30	42	30	43
MBR892	2015	FREDERICK	UNION	60	111	56	30
MCAM845	2015	DORSEY	Washington-Union	60	50	25	30
MP404	2015	Washington-Union	BWI	60	32	30	56
MP502	2015	UNION STATION	BWI	60	35	30	51
VFRED1I	2015	Spotsylvania	Washington-Union Station	30	103	60	35
VMAS321	2015	Washington-Union Station	Broad Run	60	75	36	29
VMAS51I	2015	BROAD RUN AIRPORT VRE	UNION STATION	30	75	36	29
AMTK86I	2017	Spotsylvania	UNION STATION VRE	60	87	60	41
MBR876	2017	BRUNSWICK STATION	UNION STATION	60	95	50	32
MBR878	2017	Duffields WVA	Union Station	60	111	62	34
MCAM847	2017	DORSEY	UNION STATION	60	54	25	28
MCAM840	2017	UNION STATION	DORSEY	60	47	25	32
MP407511	2017	BWI	UNION STATION	30	42	30	43
MBR892	2017	FREDERICK	UNION	60	111	56	30
MCAM845	2017	DORSEY	Washington-Union	60	50	25	30
MP404	2017	Washington-Union	BWI	60	32	30	56
MP502	2017	UNION STATION	BWI	60	35	30	51
MP409	2017	BWI	UNION STATION	60	36	30	50
VMAS321	2017	Washington-Union Station	Broad Run	60	75	36	29
VMAS51I	2017	BROAD RUN AIRPORT VRE	UNION STATION	30	75	36	29
VFRED1I	2017	Spotsylvania	Washington-Union Station	30	105	60	34
AMTK86I	2020	Spotsylvania	UNION STATION VRE	60	87	60	41
MCAM840	2020	UNION STATION	DORSEY	60	47	25	32
MBR876	2020	BRUNSWICK STATION	UNION STATION	60	95	50	32
MBR878	2020	Duffields WVA	Union Station	60	111	62	34
MCAM847	2020	DORSEY	UNION STATION	60	54	25	28
MP407511	2020	BWI	UNION STATION	30	42	30	43
MBR892	2020	FREDERICK	UNION	60	111	56	30
MCAM845	2020	DORSEY	Washington-Union	60	50	25	30
MP404	2020	Washington-Union	BWI	60	32	30	56
MP502	2020	UNION STATION	BWI	60	35	30	51
MP409	2020	BWI	UNION STATION	60	36	30	50
VMAS321	2020	Washington-Union Station	Broad Run	60	75	36	29
VMAS51I	2020	BROAD RUN AIRPORT VRE	UNION STATION	20	75	36	29
VFRED1I	2020	Spotsylvania	Washington-Union Station	20	105	60	34

**Table 3-29 AM peak-period commuter rail summary by year: 2025 and 2030**

Transit Route Name	Transit Year	Origin	Destination	Hdwy	RT(mins.)	Dis.(mi)	Spd(mph)
AMTK86I	2025	Spotsylvania	UNION STATION VRE	60	87	60	41
MCAM840	2025	UNION STATION	DORSEY	60	47	25	32
MBR876	2025	BRUNSWICK STATION	UNION STATION	60	95	50	32
MBR878	2025	Duffields WVA	Union Station	60	111	62	34
MCAM847	2025	DORSEY	UNION STATION	60	54	25	28
MP407511	2025	BWI	UNION STATION	30	42	30	43
MBR892	2025	FREDERICK	UNION	60	111	56	30
MCAM845	2025	DORSEY	Washington-Union	60	50	25	30
MP404	2025	Washington-Union	BWI	60	32	30	56
MP502	2025	UNION STATION	BWI	60	35	30	51
MP409	2025	BWI	UNION STATION	60	36	30	50
VMAS321	2025	Washington-Union Station	Broad Run	60	75	36	29
VMAS51I	2025	BROAD RUN AIRPORT VRE	UNION STATION	20	75	36	29
VFRED1I	2025	Spotsylvania	Washington-Union Station	20	105	60	34
AMTK86I	2030	Spotsylvania	UNION STATION VRE	60	87	60	41
MCAM840	2030	UNION STATION	DORSEY	60	47	25	32
MBR876	2030	BRUNSWICK STATION	UNION STATION	60	95	50	32
MBR878	2030	Duffields WVA	Union Station	60	111	62	34
MCAM847	2030	DORSEY	UNION STATION	60	54	25	28
MP407511	2030	BWI	UNION STATION	30	42	30	43
MBR892	2030	FREDERICK	UNION	60	111	56	30
MCAM845	2030	DORSEY	Washington-Union	60	50	25	30
MP404	2030	Washington-Union	BWI	60	32	30	56
MP502	2030	UNION STATION	BWI	60	35	30	51
MP409	2030	BWI	UNION STATION	60	36	30	50
MCAMNEW	2030	UNION STATION	DORSEY	60	47	25	32
MBRNEW1	2030	BRUNSWICK STATION	UNION STATION	60	95	50	32
MBRNEW2	2030	UNION STATION	BRUNSWICK STATION	60	94	50	32
MPENNEW	2030	BWI	UNION STATION	60	36	30	50
VMAS321	2030	Washington-Union Station	Broad Run	60	75	36	29
VMAS51I	2030	BROAD RUN AIRPORT VRE	UNION STATION	20	75	36	29
VFRED1I	2030	Spotsylvania	Washington-Union Station	20	105	60	34

**Note:** AM peak period is from 6:00 – 6:59 AM. Years 2030 and 2040 commuter rail data is the same as 2025.

Ref: "I:\ateam\docum\FY16\2015CLRP\_Network\_Report\NW\_Report\_Tables\CLRP\_2015\_Met\_Com\_BRT\_Files.xlsx"

Source: 2015 CLRP and FY2015-2020 TIP

**Table 3-30 Off-peak-period commuter rail summary by year: 2015, 2017, 2020, and 2025**

Transit Route Name	Transit Year	Origin	Destination	Hdwy	RT(mins.)	Dis.(mi)	Spd(mph)
AMTK94I	2015	Spotsylvania	Washington-Union Station	60	101	60	36
AMTK95O	2015	UNION STATION VRE	Spotsylvania	60	79	60	46
AMTK176	2015	MANASSAS	UNION STATION	60	61	33	32
MBR871	2015	UNION STATION	BRUNSWICK STATION	60	94	50	32
MPEN1O	2015	UNION STATION	BWI	60	35	30	51
MPEN1I	2015	BWI	UNION STATION	60	39	30	46
VFR301	2015	Washington-Union Station	Spotsylvania	60	101	60	36
VMAS336	2015	Broad Run	Washington-Union Station	60	70	36	31
VMAS325	2015	UNION STATION	BROAD RUN	60	73	36	30
AMTK94I	2017	Spotsylvania	Washington-Union Station	60	103	60	35
AMTK95O	2017	UNION STATION VRE	Spotsylvania	60	81	60	44
AMTK176	2017	MANASSAS	UNION STATION	60	61	33	32
MBR871	2017	UNION STATION	BRUNSWICK STATION	60	94	50	32
MPEN1I	2017	BWI	UNION STATION	60	39	30	46
MPEN1O	2017	UNION STATION	BWI	60	35	30	51
VFR301	2017	Washington-Union Station	Spotsylvania	60	103	60	35
VMAS336	2017	Broad Run	Washington-Union Station	60	70	36	31
VMAS325	2017	UNION STATION	BROAD RUN	60	73	36	30
AMTK94I	2020	Spotsylvania	Washington-Union Station	60	103	60	35
AMTK95O	2020	UNION STATION VRE	Spotsylvania	60	81	60	44
AMTK176	2020	MANASSAS	UNION STATION	60	61	33	32
MBR871	2020	UNION STATION	BRUNSWICK STATION	60	94	50	32
MPEN1I	2020	BWI	UNION STATION	60	39	30	46
MPEN1O	2020	UNION STATION	BWI	60	35	30	51
VFR301	2020	Washington-Union Station	Spotsylvania	60	103	60	35
VMAS336	2020	Broad Run	Washington-Union Station	60	70	36	31
VMAS325	2020	UNION STATION	BROAD RUN	60	73	36	30
AMTK94I	2025	Spotsylvania	Washington-Union Station	60	103	60	35
AMTK95O	2025	UNION STATION VRE	Spotsylvania	60	81	60	44
AMTK176	2025	MANASSAS	UNION STATION	60	61	33	32
MBR871	2025	UNION STATION	BRUNSWICK STATION	60	94	50	32
MPEN1I	2025	BWI	UNION STATION	60	39	30	46
MPEN1O	2025	UNION STATION	BWI	60	35	30	51
VFR301	2025	Washington-Union Station	Spotsylvania	60	103	60	35
VMAS336	2025	Broad Run	Washington-Union Station	60	70	36	31
VMAS325	2025	UNION STATION	BROAD RUN	60	73	36	30

**Note:** Off-peak period is from 10:00 AM- 2:59 PM. Years 2030 and 2040 commuter rail data is the same as 2025.

Ref: "I:\ateam\docum\FY16\2015CLRP\_Network\_Report\NW\_Report\_Tables\CLRP\_2015\_Met\_Com\_BRT\_Files.xlsx"

Source: 2015 CLRP and FY2015-2020 TIP

**Table 3-31 AM peak-period Light Rail / BRT Streetcar summary by year: 2015, 2017, 2020, 2025, and 2030**

Transit Route Name	Transit Year	Origin	Destination	Hdwy	RT(mins.)	Dis.(mi)	Spd(mph)
DCSTHST1	2017	UNION STATION	OKLAHOMA AVE	30	12	1	5
MWAYN	2017	Braddock Rd Metro	Crystal City Metro	12	20	4	12
MWAYS	2017	Crystal City Metro	Braddock Rd Metro	12	20	4	12
DCSTCARA	2017	BOLLING AFB	GOOD HOPE RD & MLK	30	12	1	5
DCSTHST1	2020	UNION STATION	OKLAHOMA AVE	30	12	1	5
MWAYN	2020	Braddock Rd Metro	Crystal City Metro	12	20	4	12
MWAYS	2020	Crystal City Metro	Braddock Rd Metro	12	20	4	12
DCSTCARA	2020	BOLLING AFB	GOOD HOPE RD & MLK	30	12	1	5
DCSTHST2	2020	UNION STATION	BENNING ROAD METRO	10	24	4	10
DCSTMST	2020	Good Hope Rd SE	Maine Ave. SW	30	20	2	6
DCSTGTWN	2020	Union Station/ H St.	Georgetown	10	25	3	7
PURLRT	2020	Bethesda	New Carrollton	12	59	16	16
CCTBRT	2020	METRO GROVE	SHADY GROVE	8	25	10	24
DCSTHST1	2025	UNION STATION	OKLAHOMA AVE	30	12	1	5
MWAYN	2025	Braddock Rd Metro	Crystal City Metro	12	20	4	12
MWAYS	2025	Crystal City Metro	Braddock Rd Metro	12	20	4	12
DCSTCARA	2025	BOLLING AFB	GOOD HOPE RD & MLK	30	12	1	5
DCSTHST2	2025	UNION STATION	BENNING ROAD METRO	10	24	4	10
DCSTMST	2025	Good Hope Rd SE	Maine Ave. SW	30	20	2	6
DCSTGTWN	2025	Union Station/ H St.	Georgetown	10	25	3	7
CCTBRT	2025	METRO GROVE	SHADY GROVE	8	25	10	24
PURLRT	2025	Bethesda	New Carrollton	12	59	16	16
US1BRT	2030	HUNTINGTON METRO S	WOODBIDGE VRE	12	38	1	2
DCSTHST1	2030	UNION STATION	OKLAHOMA AVE	30	12	4	20
MWAYN	2030	Braddock Rd Metro	Crystal City Metro	12	20	4	12
MWAYS	2030	Crystal City Metro	Braddock Rd Metro	12	20	1	3
DCSTCARA	2030	BOLLING AFB	GOOD HOPE RD & MLK	30	12	4	20
DCSTHST2	2030	UNION STATION	BENNING ROAD METRO	10	24	2	5
DCSTMST	2030	Good Hope Rd SE	Maine Ave. SW	30	20	3	9
DCSTGTWN	2030	Union Station/ H St.	Georgetown	10	25	10	24
CCTBRT	2030	METRO GROVE	SHADY GROVE	8	25	15	36
PURLRT	2030	Bethesda	New Carrollton	12	59	16	16

**Note:** AM peak period is from 7:00 – 7:59 AM. Year 2040 Light Rail / BRT Street car data is the same as 2030

Ref: "I:\ateam\docum\FY16\2015CLRP\_Network\_Report\NW\_Report\_Tables\CLRP\_2015\_Met\_Com\_BRT\_Files.xlsx"

Source: 2015 CLRP and FY2015-2020 TIP



**Table 3-32 Off-peak-period Light Rail / BRT Streetcar summary by year: 2015, 2017, 2020, 2025, 2030**

Transit Route Name	Transit Year	Origin	Destination	Hdwy	RT(mins.)	Dis.(mi)	Spd(mph)
DCSTHST1	2017	UNION STATION	OKLAHOMA AVE	30	12	1	5
MWAYN	2017	Braddock Rd Metro	Crystal City Metro	12	20	4	12
MWAYS	2017	Crystal City Metro	Braddock Rd Metro	12	20	4	12
DCSTCARA	2017	BOLLING AFB	GOOD HOPE RD & MLK	30	12	1	5
DCSTHST1	2020	UNION STATION	OKLAHOMA AVE	30	12	1	5
MWAYN	2020	Braddock Rd Metro	Crystal City Metro	12	20	4	12
MWAYS	2020	Crystal City Metro	Braddock Rd Metro	12	20	4	12
DCSTCARA	2020	BOLLING AFB	GOOD HOPE RD & MLK	30	12	1	5
DCSTHST2	2020	UNION STATION	BENNING ROAD METRO	10	24	4	10
DCSTMST	2020	Good Hope Rd SE	Maine Ave. SW	30	20	2	6
DCSTGTWN	2020	Union Station/ H St.	Georgetown	10	25	3	7
PURLRT	2020	Bethesda	New Carrollton	12	59	16	16
CCTBRT	2020	METRO GROVE	SHADY GROVE	8	25	10	24
DCSTHST1	2025	UNION STATION	OKLAHOMA AVE	30	12	1	5
MWAYN	2025	Braddock Rd Metro	Crystal City Metro	12	20	4	12
MWAYS	2025	Crystal City Metro	Braddock Rd Metro	12	20	4	12
DCSTCARA	2025	BOLLING AFB	GOOD HOPE RD & MLK	30	12	1	5
DCSTHST2	2025	UNION STATION	BENNING ROAD METRO	10	24	4	10
DCSTMST	2025	Good Hope Rd SE	Maine Ave. SW	30	20	2	6
DCSTGTWN	2025	Union Station/ H St.	Georgetown	10	25	3	7
CCTBRT	2025	METRO GROVE	SHADY GROVE	8	25	10	24
PURLRT	2025	Bethesda	New Carrollton	12	59	16	16
US1BRT	2030	HUNTINGTON METRO S	WOODBIDGE VRE	12	38	1	2
DCSTHST1	2030	UNION STATION	OKLAHOMA AVE	30	12	4	20
MWAYN	2030	Braddock Rd Metro	Crystal City Metro	12	20	4	12
MWAYS	2030	Crystal City Metro	Braddock Rd Metro	12	20	1	3
DCSTCARA	2030	BOLLING AFB	GOOD HOPE RD & MLK	30	12	4	20
DCSTHST2	2030	UNION STATION	BENNING ROAD METRO	10	24	2	5
DCSTMST	2030	Good Hope Rd SE	Maine Ave. SW	30	20	3	9
DCSTGTWN	2030	Union Station/ H St.	Georgetown	10	25	10	24
CCTBRT	2030	METRO GROVE	SHADY GROVE	8	25	15	36
PURLRT	2030	Bethesda	New Carrollton	12	59	16	16

**Note:** Off-peak period is from 10:00 AM- 2:59 PM. Year 2040 Light Rail / BRT Street car data is the same as 2030.

Ref: "I:\ateam\docum\FY16\2015CLRP\_Network\_Report\NW\_Report\_Tables\CLRP\_2015\_Met\_Com\_BRT\_Files.xlsx"

Source: 2015 CLRP and FY2015-2020 TIP

Summaries of transit service in the TPB modeled region by mode and time period are shown in Table 3-33. Although the year 2040 is not shown in the table, the transit service for this year is the same as that shown for the year-2030 network. The transit lines shown are directional, i.e., transit lines coded as two-way are counted twice and one-way routes are counted once. From 2015 to 2030, it is expected that the AM lane-miles of transit will increase by 873 miles and the off-peak lane-miles of transit will increase by 452 miles.

**Table 3-33 Number of transit lines and line miles coded in networks: 2015, 2017, 2020, 2025 and 2030**

AM Period		2015		2017		2020		2025		2030		Diff 2030 - 2015	
Mode	Mode Description	# Transit Lines	Transit Line miles	# Transit Lines	Transit Line miles	# Transit Lines	Transit Line miles	# Transit Lines	Transit Line miles	# Transit Lines	Transit Line miles	# Transit Lines	Transit Line miles
1	Local Metrobus	398	3,421	398	16,811	398	3,433	398	3,433	398	3,433	0	12
2	Express Metrobus	46	574	46	1,621	57	803	57	803	57	803	11	229
3	Metrorail	16	401	16	900	16	424	16	425	16	425	0	24
4	Commuter Rail	14	554	14	955	14	554	14	554	18	707	4	154
5	Light Rail	0	0	0	0	2	31	2	31	2	31	2	31
6	Primary Local Bus	350	3,082	357	12,747	357	3,176	357	3,175	357	3,176	7	94
7	Primary Express Bus	22	722	22	1,431	22	722	32	979	32	979	10	257
8	Secondary Local Bus	137	1,791	137	6,172	137	1,791	137	1,791	137	1,791	0	0
9	Secondary Express Bus	81	3,123	81	6,728	81	3,123	81	3,125	81	3,125	0	2
10	BRT/Streetcar	4	10	6	88	14	51	14	51	16	81	12	71
	<b>Sum</b>	<b>1,068</b>	<b>13,679</b>	<b>1,077</b>	<b>47,453</b>	<b>1,098</b>	<b>14,109</b>	<b>1,108</b>	<b>14,369</b>	<b>1,114</b>	<b>14,553</b>	<b>46</b>	<b>873</b>

Off Peak Period		2015		2017		2020		2025		2030		Diff 2030 - 2015	
Mode	Mode Description	# Transit Lines	Transit Line miles	# Transit Lines	Transit Line miles	# Transit Lines	Transit Line miles	# Transit Lines	Transit Line miles	# Transit Lines	Transit Line miles	# Transit Lines	Transit Line miles
1	Local Metrobus	312	2,760	312	13,746	312	2,772	312	2,772	312	2,772	0	11
2	Express Metrobus	15	238	15	621	23	378	23	378	23	378	8	140
3	Metrorail	14	353	14	800	14	376	14	377	14	377	0	24
4	Commuter Rail	9	393	9	659	9	393	9	393	9	393	0	0
5	Light Rail	0	0	0	0	2	31	2	31	2	31	2	31
6	Primary Local Bus	276	2,456	276	9,851	278	2,473	278	2,474	278	2,474	2	18
7	Primary Express Bus	13	418	13	926	13	418	19	575	19	575	6	157
8	Secondary Local Bus	150	1,825	150	6,690	150	1,825	150	1,825	150	1,825	0	0
9	Secondary Express Bus	32	1,140	32	2,585	32	1,140	32	1,140	32	1,140	0	0
10	BRT/Streetcar	4	10	6	88	14	51	14	51	16	81	12	71
	<b>Sum</b>	<b>825</b>	<b>9,593</b>	<b>827</b>	<b>35,966</b>	<b>847</b>	<b>9,857</b>	<b>853</b>	<b>10,015</b>	<b>855</b>	<b>10,045</b>	<b>30</b>	<b>452</b>

Source: 2015 CLRP and FY2015-2020 TIP

Notes: Lane miles are directional, not centerline.

Ref: I:\ateam\docum\FY16\2015CLRP\_Network\_Report\NW\_Report\_Tables\Trn\_Lines\_Miles.xlsx

### 3.4 Transit path building

The transit path building and path skimming process involves the development of 22 sets of level-of-service (LOS) skims (matrices) corresponding to two time-of-day period (peak and off-peak), by four transit sub-modes (bus only, Metrorail only, bus-Metrorail combination, and commuter rail), by three access modes (walk, PNR, KNR). For the calculation of average headways and run times, the peak period is represented by the AM peak hour, and the off-peak period is represented by the five-hour midday period. Although one might expect 24 sets of skims (2x3x4), there are only 22 since KNR access to commuter rail mode is not considered by the mode choice model, and so the total number of required path sets equals 22. This process is shown schematically in Figure 3-25 and is covered in more detail in Chapter 22 Section 22.6 of the Version 2.3.57a User’s Guide dated October 29, 2015.

Figure 3-25 Process for conducting transit path building

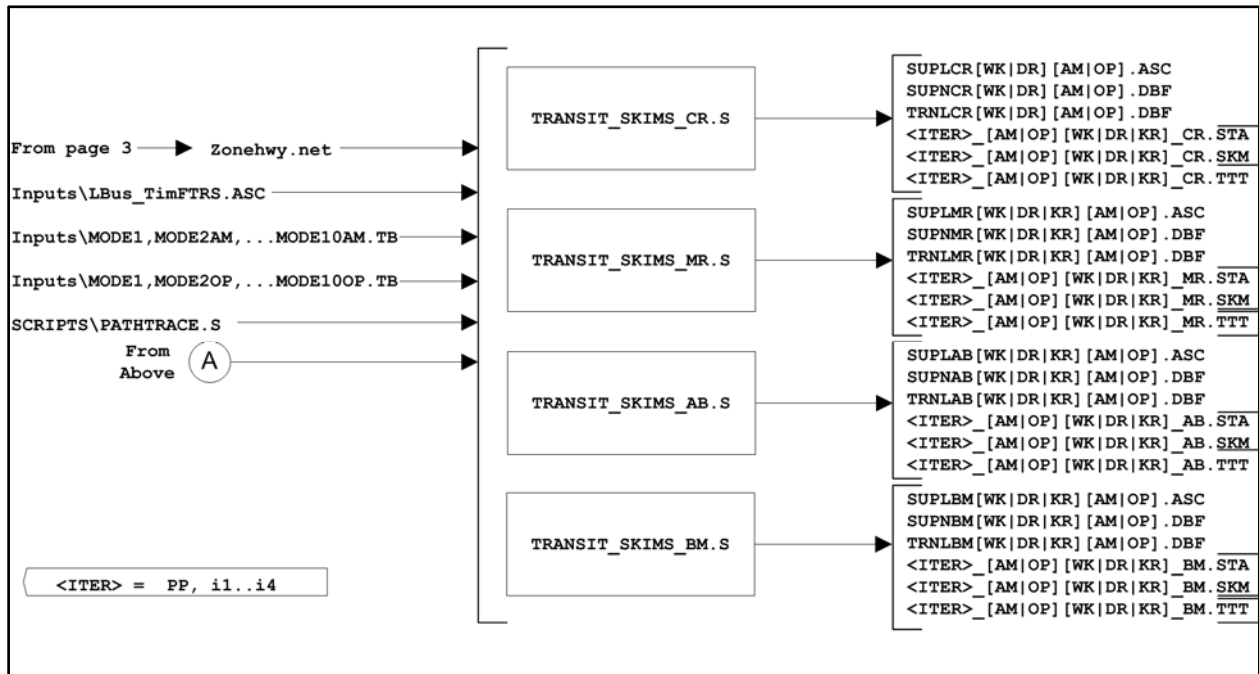

## 3.5 Transit Fare Files

### 3.5.1 Gathering fare data from the transit providers

WMATA is the dominant transit operator in the Washington, D.C. area, operating both the Metrorail and Metrobus systems. WMATA was created in 1967 as an interstate compact agency.<sup>23</sup> The formal name for its area of coverage is the “Washington Metropolitan Area Transit Zone” (WMATZ), but it is more commonly referred to as the WMATA Compact area. As of 2009, the area includes the following jurisdictions:

- District of Columbia
- The following cities in Virginia
  - Alexandria
  - Falls Church
  - Fairfax
- The following counties in Virginia
  - Arlington
  - Fairfax
  - Loudoun
- The following counties in Maryland
  - Montgomery
  - Prince George’s

The tariff used for this analysis was Tariff #33v2, effective July 1, 2014.

In addition to the WMATA tariff, transit fare data is collected for the other transit operators in the modeled area (see Table 3-20), such as Ride On, ART, Fairfax Connector, MARC, VRE, and PRTC/Omni. A recent memo discusses the collection of transit fare data for the region.<sup>24</sup>

### 3.5.2 Calculating zone-to-zone fares used by the model

The COG transit fare programs are known as MFARE1 and MFARE2. These were originally written as UMODEL programs, known as RPFARE1 and RPFARE2,<sup>25</sup> within the UTPS mainframe software system. In the early 1990s, they were then converted to FORTRAN programs called MFARE1 and MFARE2 for the Maryland Department of Transportation, and then, a year later, they were converted to Microsoft FORTRAN 5.0 for use with MINUTP.<sup>26</sup> The FORTRAN version was used in the Version 2.1D #50 Travel Model, in 2004. In 2007 or 2008, MFARE1 and MFARE2 were converted to TP+ scripts (which is now Cube Voyager), though the conversion was not documented, and the MFARE1 and MFARE2 scripts were first used in the Version 2.2 Travel Model in the spring of 2008.

---

<sup>23</sup> “WMATA Compact, as Amended through August 2009” (Washington Metropolitan Area Transit Authority, August 2009), [http://www.wmata.com/about\\_metro/docs/Compact\\_Annotated\\_2009\\_final.pdf](http://www.wmata.com/about_metro/docs/Compact_Annotated_2009_final.pdf).

<sup>24</sup> Jane Posey to Files, “Transit Fares for the 2014 CLRP and FY2015-2020 TIP Air Quality Conformity Analysis,” Memorandum, December 31, 2014.

<sup>25</sup> “RP” stands for the name of the original developer: Richard Pratt.

<sup>26</sup> William G. Allen Jr., *User’s Guide for the MFCOG Fare Programs, Microcomputer Version*, Final (Metropolitan Washington Council of Governments, June 1992), 2.

**MFARE1 estimates station-to-station Metrorail fares**, which are distance based. According to WMATA policy, the distance used is the “composite distance,” which is the average of the straight-line (airline) distance between Metrorail stations and the actual over-the-rail distance between stations.<sup>27</sup> **MFARE2 first calculates non-Metrorail transit fares (commonly referred to as “bus” fares**, even though non-Metrorail transit also includes commuter rail, LRT, and BRT). **Next, MFARE2 outputs the following zone-to-zone matrices:**

1. Total transit fares. For paths that include Metrorail, this would include both the Metrorail fare and any other non-Metrorail transit fare that is involved.
2. Metrorail-only fares
3. “Bus”-only fares (i.e., non-Metrorail-transit-only fares)
4. “Bus” access to Metrorail fares (i.e., non-Metrorail-transit access to Metrorail fares)
5. “Bus” egress from Metrorail fares (i.e., non-Metrorail-transit egress from Metrorail fares)<sup>28</sup>

MFARE1 estimates station-to-station Metrorail fares using the composite distance, according to the following procedure, which is based on rules in the WMATA tariff:

- A fixed boarding fare charged for the first few miles.
- A secondary fare charged for the next few miles.
- A "tertiary" fare per mile charged for the remaining miles of the trips.
- The sum of above three fare elements should be less or equal to a maximum fare.
- Calculate discounted fare which applies to certain stations.
- Output final fares to a station-to-station matrix.<sup>29</sup>

One of the key inputs to the MFARE1 process is the section of the WMATA Tariff dealing with Metrorail fares (see, for example, Table 3-34). From this table, we can see that there is a peak and an off-peak fare and there is a maximum peak and off peak fare (\$5.90 and \$3.60). However, as noted at the bottom of the table, there is a \$1.00 surcharge for all non-SmarTrip single-ride fares. Since the travel model cannot differentiate SmarTrip card users from non-SmarTrip card users, an adjustment is made to fare data input to the model. According to WMATA, 10% of Metrorail riders use cash farecards, which means their base fare is \$3.15, not \$2.15. Assuming that the remaining 90% are paying with a SmarTrip (or a similar fare from a monthly), we can calculate a new, slightly higher, average base fare of \$2.25:

$$(\$2.15) * (90\% \text{ of riders}) + (\$2.15 + \$1.00) * (10\% \text{ of riders}) = \$2.25.$$

This concept is shown in Figure 3-26. Further details can be found in the recent memo.<sup>30</sup> The actual WMATA fare tariff data is input to the model using the file tariff.txt (see Figure 3-27).

---

<sup>27</sup> Washington Metropolitan Area Transit Authority, “Tariff of the Washington Metropolitan Area Transit Authority on Metro Operations within the Washington Metropolitan Area, Tariff Number 33v2, Effective July 1, 2014,” Pg 4.

<sup>28</sup> Allen, *User’s Guide for the MWCOG Fare Programs, Microcomputer Version*, 2.

<sup>29</sup> *Ibid.*, 3.

<sup>30</sup> Posey to Files, “Transit Fares for the 2014 CLRP and FY2015-2020 TIP Air Quality Conformity Analysis.”

Table 3-34 Metrorail fare structure, WMATA Tariff #33v2

Metrorail Fare Structure (Effective July 1, 2014)	Regular Fares		Senior & Disabled Fares <sup>(3)(4)</sup>
	Peak <sup>(1)</sup>	Off-Peak <sup>(2)(6)</sup>	
First 3 composite miles <sup>(5)</sup>	\$ 2.15		One-half peak fare
Each additional composite mile more than 3 and less than or equal to 6	\$ 0.326		
Each composite mile greater than 6	\$ 0.288		
Maximum peak fare (Exclusive of Surcharge and Differentials)	\$ 5.90		
First 3 composite miles <sup>(5)</sup>		\$ 1.75	One-half peak fare
Each additional composite mile more than 3 and less than or equal to 6		\$ 0.244	
Each composite mile greater than 6		\$ 0.216	
Maximum off-peak fare		\$ 3.60	
A \$1.00 surcharge applies to all non-SmarTrip® single-ride fares (\$0.50 for senior & disabled)			

**Notes:**

- A. Peak and off-peak fares will be determined by the time riders enter through the rail faregates.
- B. Only a Metrorail Farecard, valid pass, SmarTrip® Card, or an emergency trip ticket are accepted as rail payment.
- C. All Metrorail fares round to the nearest \$0.05
- D. A \$0.05 surcharge on entry and exist at up to two stations in each jurisdiction in the Compact Transit Zone for the purpose of funding station-specific capital improvements to Metro facilities located at the station(s) where the surcharge is levied may be imposed with further Board approval. No such stations are currently authorized
- E. Patrons must have a minimum of \$1.25 in value on their SmarTrip® card (\$2.25 on a paper farecard) to enter the Metrorail system. Senior or disabled patrons must have a minimum of \$0.55 in value on their SmarTrip® card (\$1.05 on a reduced fare paper farecard) to enter the Metrorail system.
- F. Patrons may not exit the Metrorail system with a negative balance in excess of \$1.50 on their SmarTrip® card. Patrons attempting to exit the Metrorail system with a negative SmarTrip® balance in excess of \$1.50 must use the Exitfare machines to add value before exiting.

**Footnotes:**

- (1) Peak fares are in effect from opening through 9:30a.m. and from 3:00p.m. to 7:00p.m. weekdays, except for national holidays. Peak fares are also in effect from 12:00a.m. to 3:00a.m. Saturday and Sunday to accommodate late night Friday and Saturday service.
- (2) Off-Peak fares shall be in effect during all other hours on weekdays, Saturday and Sunday, and all national holidays.
- (3) Fares for seniors and patrons with disabilities are one-half the peak fare rounded down to the nearest \$0.05, including any applicable surcharge and differential, when using applicable fare media.
- (4) Effective June 27, 2010, new and recertifying MetroAccess customers shall be eligible for the "Free Ride Program" only if they are determined to be conditionally eligible for paratransit service; provided that existing MetroAccess customers (and one personal care assistant per customer) may continue participating in the Free Ride Program until their current period of paratransit eligibility expires.
- (5) A composite mile is the average of the straight-line (airline) distance between stations and the actual over-the-rail distance
- (6) Martin Luther King, Jr. Day, President's Day, Columbus Day, and Veteran's Day the Metrobus system will operate under a modified holiday schedule and will charge base fare on all routes; the Metrorail system will operate on a holiday schedule with off-peak fares in place and that parking at Metro parking facilities will be free.

Source: WMATA. "Tariff of the Washington Metropolitan Area Transit Authority on Metro Operations within the Washington Metropolitan Area, Tariff Number 33V2, Effective July 1, 2014," July 1, 2014.

Figure 3-26 Metrorail fare structure, WMATA Tariff #33v2: Adjustments made for input to model

Metrorail Fare Structure (Effective July 1, 2014)	Regular Fares		Senior & Disabled Fares <sup>(3)(4)</sup>
	Peak <sup>(1)</sup>	Off-Peak <sup>(2)(6)</sup>	
First 3 composite miles <sup>(5)</sup>	\$ <del>2.15</del>		One-half peak fare
Each additional composite mile more than 3 and less than or equal to 6	\$ 0.326		
Each composite mile greater than 6	\$ 0.288		
Maximum peak fare (Exclusive of Surcharge and Differentials)	\$ <del>5.90</del>		
First 3 composite miles <sup>(5)</sup>		\$ <del>1.75</del>	One-half peak fare
Each additional composite mile more than 3 and less than or equal to 6		\$ 0.244	
Each composite mile greater than 6		\$ 0.216	
Maximum off-peak fare		\$ <del>3.60</del>	
A \$1.00 surcharge applies to all non-SmarTrip® single-ride fares (\$0.50 for senior & disabled)			

Weighted for non-smarttrip card users: \$2.25; \$6.00; \$1.85; \$3.70

Ref: I:\ateam\docum\FY16\2015CLRP\_Network\_Report\NW\_Report\_Tables\Bus Fare Matrix 2015.xls

Figure 3-27 Metrorail fares (peak and off-peak) and the rail-to-bus discounts (Tariff.txt)

```

;;-----
;; WMATA Tariff 33v2 effective July 1 2014 fare structure input to MFARE2.S
;; Note: assumed a composit of SmarTrip and non SmarTrip rates for metrorail
;; using percents from Wendy Jia 11/26/2013 email
;;
;; WMATA has changed the off-peak fare structure to charge by composite
;; mile after the first 3 composite miles (a similar structure
;; to that used for peak service fares)
;;
;; (Prepared April 1, 2015/jp)
;;-----
;; Peak and OffPeak Metrorail Policy
;;
;; Fare Increment      Fare Rate in Cents      Trip Distance Increment(in Composite Miles)
;; in Cents           per Composite mile:    Associated with Fare Increment/Rate
;;-----
Pk_Fare_Incr1 = 225.0  Pk_Fare_Rate1 = 0.0   Pk_Fare_Dist1 = 3.0 ;
Op_Fare_Incr1 = 185.0  Op_Fare_Rate1 = 0.0   Op_Fare_Dist1 = 3.0 ;

Pk_Fare_Incr2 = 0.0   Pk_Fare_Rate2 = 33.0  Pk_Fare_Dist2 = 3.0 ;
Op_Fare_Incr2 = 0.0   Op_Fare_Rate2 = 24.0  Op_Fare_Dist2 = 3.0 ;

Pk_Fare_Incr3 = 0.0   Pk_Fare_Rate3 = 29.0          ;
Op_Fare_Incr3 = 0.0   Op_Fare_Rate3 = 22.0          ;

Pk_Fare_Max   = 600.0          ;
Op_Fare_Max   = 370.0          ;

;;-----
;; Rail-to-Bus discounts in current year cents based on selected tariff ;;
;;
DC_RailBus_Disc = 125.0 ; Area defined by Jur='0' in the zone file input ;; Discount available to SmartTrip
card holders only
MD_RailBus_Disc = 125.0 ; Area defined by Jur='1' in the zone file input ;;
VA1_RailBusDisc = 125.0 ; Area defined by Jur='2' in the zone file input ;;
VA2_RailBusDisc = 125.0 ; Area defined by Jur='3' in the zone file input ;;

```

MFARE2 calculates “bus” (non-Metrorail transit) fares using a set of “bus” fare zones. The current program allows for up to 21 bus fare zones in the modeled area. Each TAZ must be associated with either one or two bus fare zones. This is done in the TAZ fare zone file (TAZFRZN.ASC), which is discussed later. The geography of the bus fare zones can be changed from year to year, to reflect areas that have similar transit fares, such as the area around a commuter rail line. Maps of the current bus fare zones can be seen in Figure 3-28 and Figure 3-30. The first figure shows the primary bus fare zones. The second shows the secondary bus fare zones. And the third figure shows the combined effect of overlaying the two bus fare zone systems. Bus fare zone 1 (Figure 3-28) corresponds roughly to the original WMATA Compact area, before Loudoun County was added. In some cases, the bus fare zones are in two discontinuous pieces, such as bus fare zone 2 (Figure 3-28). In some cases, the bus fare zone may be made up of three discontinuous pieces, such as bus fare zone 9, which has two sections in Figure 3-28 and one section in Figure 3-29. In Figure 3-30, we can see the combined effect: there are some parts of Frederick Co. where the TAZs are associated with only one bus fare zone (such as 8, 9 or, 10), but there are some parts of Frederick Co. where the TAZs are associated with two bus fare zones (such as 8 and 9, or 9 and 10). At any rate, no TAZ can be associated with more than two bus fare zones. Names for the 21 bus fare zones can be found in Table 3-36.



Figure 3-28 Regional Primary Bus Fare Zone Map

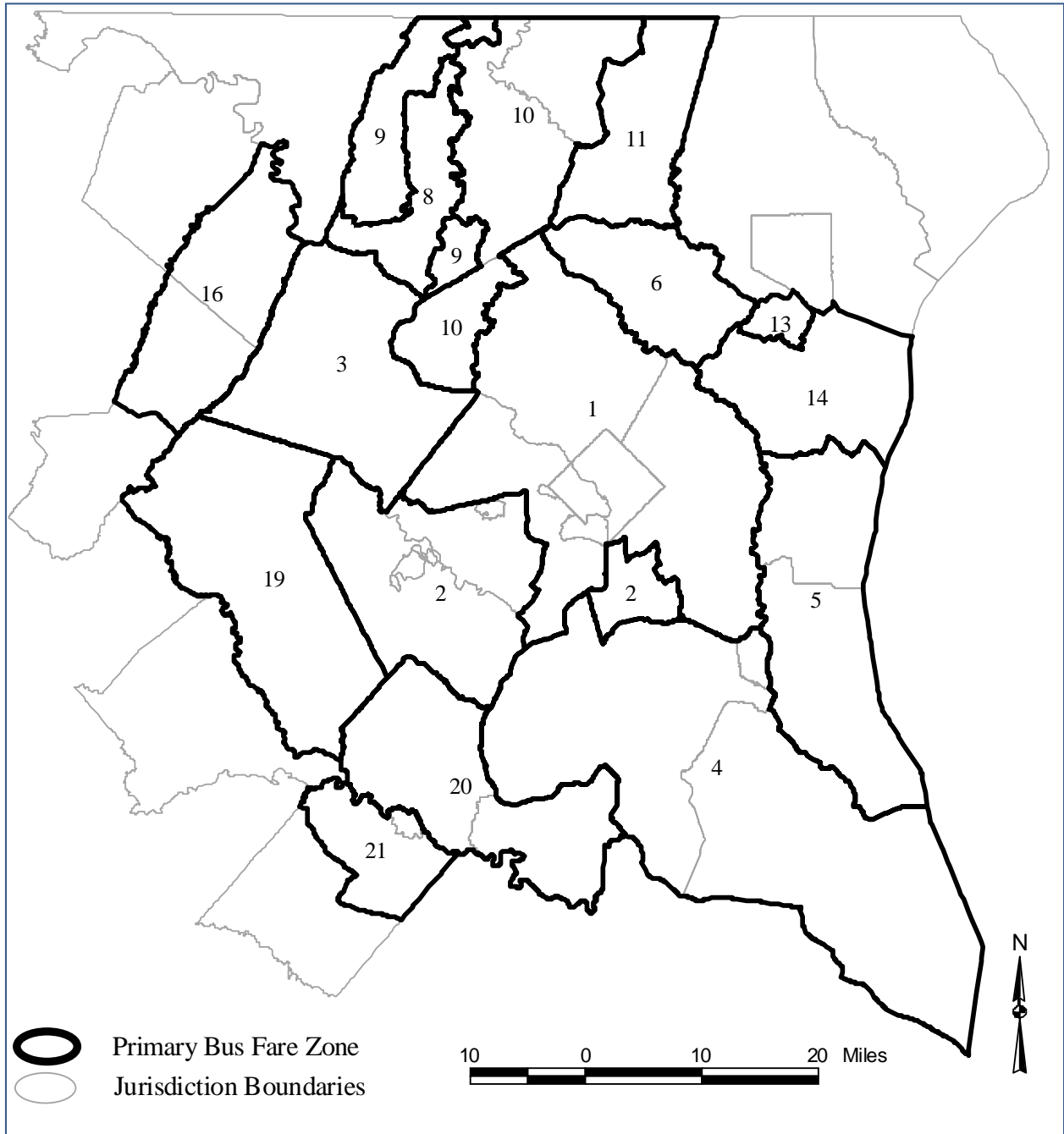

Figure 3-29 Regional Secondary Bus Fare Zone Map

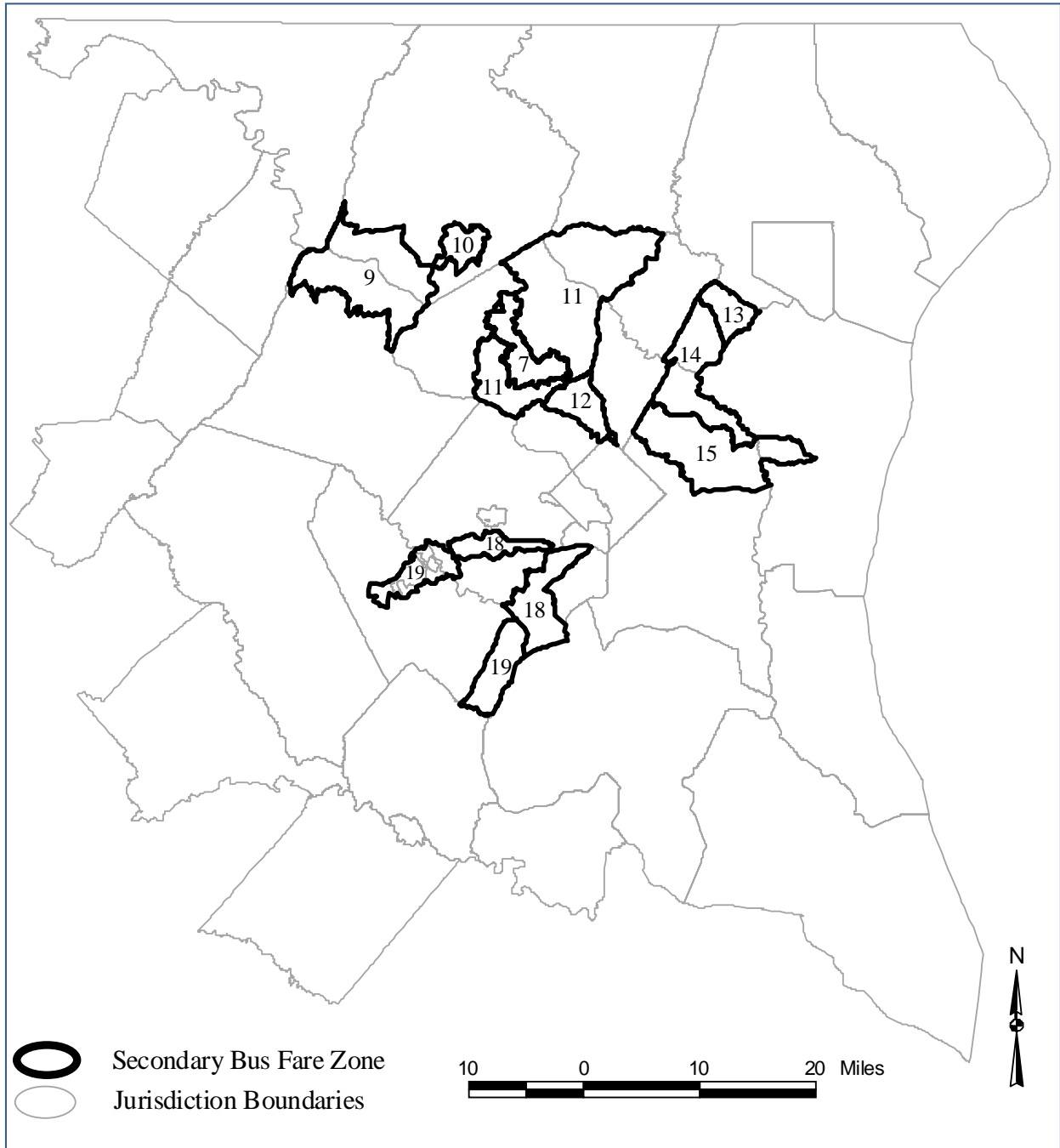
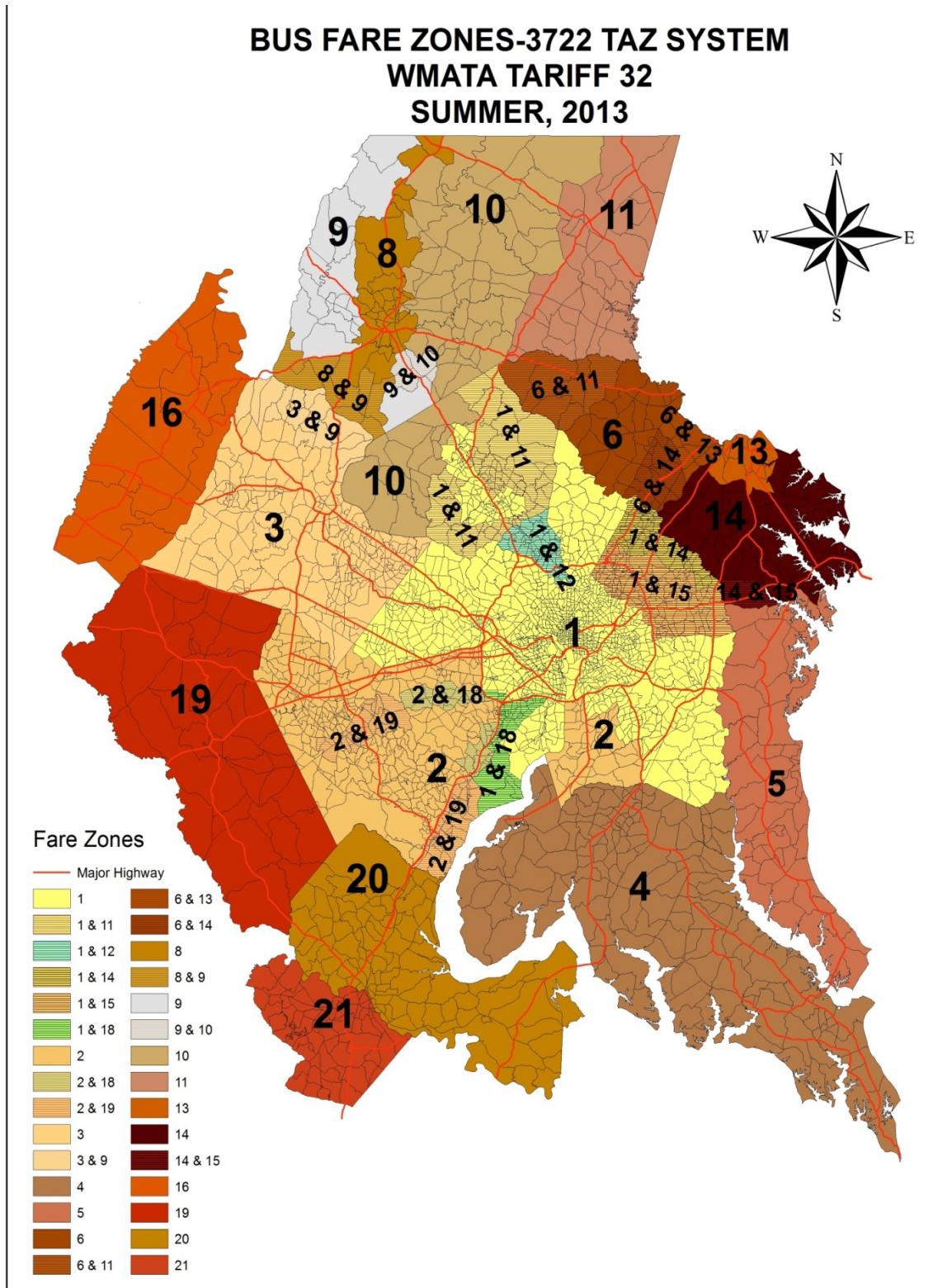

Figure 3-30 Combine bus fare zones (primary overlaid with secondary)



When a TAZ is identified as being in more than one bus fare zone, the fare is calculated using the average fare for both of the zones. Additionally, each Metrorail station must be associated with a bus fare zone. These associations between bus fare zones and TAZs, and between bus fare zones and Metrorail stations, are stored in the TAZ bus fare zone file (TAZFRZN.ASC), whose file format can be seen in Table 3-35.

**Table 3-35 File format: File relating bus fare zones to TAZs and Metrorail stations (TAZFRZN.ASC)**

Columns	Format	Field Description
<i>Zonal data (All lines in the file)</i>		
1-8	I4	TAZ Number (1-3,675) and Metrorail Station No. (1-150)
9-16	I4	1 <sup>st</sup> Bus fare zone 1 (currently numbered 1 to 21)
17-24	I4	2 <sup>nd</sup> Bus fare zone 2 (currently numbered 1 to 21)
<i>Metrorail station data (first 150 lines of the file only)</i>		
41-48	I4	1 <sup>st</sup> Bus Fare Zone (currently numbered 1 to 21)
49-56	I4	2 <sup>nd</sup> Bus Fare Zone (currently numbered 1 to 21)
57-64	I8	Jurisdiction code
65-72	I8	P discount
73-80	I8	A discount

The “bus” fare matrix is a 21-by-21 matrix that represents the average non-Metrorail-transit fares from one “bus” fare zone to another. In theory, there can be a separate bus fare zone for peak and off peak travel. In practice, COG/TPB staff has adopted the practice of using only one bus fare matrix, since there is typically little time-of-day variation in the non-Metrorail transit fares. The current bus fare matrix is shown in Table 3-36. This table also provides names for the bus fare zones.

**Table 3-36 AM Peak and Off-Peak Bus Fare Matrix between MWCOG Fare Zones (Expressed in 2014 cents)**

		WMATA			Calvert											MARC Rail					
		Express &			and		NOT USED									Brunswick			VRE Zones	VRE Zones	
		Internal		Charles &	Southern	Howard	Corridor			MARC Rail	MARC Rail		MARC Rail	MARC Rail	MARC Rail	(W. VA	VRE Zones		5 & 6 (PW	7 & 8	VRE Zone
	WMATA	Metrobus	Loudoun	St. Mary's	AA Comm	Comm.	Cities	Frederick		Brunswick	Brunswick	MARC Rail	Penn/	Penn/	Penn/	and Clark	1 & 2	VRE Zones	& FAUQ	(Staff. &	9 (Spots.
	Regular	Fare	Comm.	Comm.	Bus	Bus	Transitway	Internal		(Mont.	(Mid.	Brunswick	Camden	Camden	Camden	Auto	(Inside	3 & 4 (FFX	Auto	KG Auto	&
	Service	Service	Bus	Bus (MTA)	(MTA)	(MTA)	(Mont. Co.)	Bus		(Frederick)	(R8)	(Inner)	(Outer)	(Mid)	(Inner)	Connect	Beltway)	and PW)	Connect)	Connect)	Fred'brg)
Fare Zone	1	2	3	4	5	6	7	8	9	10	11	12	13	14	15	16	17	18	19	20	21
1	175	488	800	347	328	299	414	398	427	341	284	227	341	284	227	511	382	466	549	632	695
2	488	153	1288	835	816	787	902	886	915	829	772	715	829	772	715	999	658	210	130	407	470
3	800	1288	100	1147	1128	1099	1214	1198	1227	1141	1084	1027	1141	1084	1027	1311	1182	1266	1349	1432	1495
4	347	835	1147	100	675	646	761	745	774	688	631	574	688	631	574	858	729	813	896	979	1042
5	328	816	1128	675	357	627	742	726	755	669	612	555	669	612	555	839	710	794	877	960	1023
6	299	787	1099	646	627	299	713	697	726	640	583	526	640	583	526	810	681	765	848	931	994
7	414	902	1214	761	742	713	130	671	557	471	130	414	755	698	641	925	796	880	963	1046	1109
8	398	886	1198	745	726	697	671	114	114	541	541	541	739	682	625	513	780	864	947	1030	1093
9	427	915	1227	774	755	726	557	114	400	427	427	427	768	711	654	399	809	893	976	1059	1122
10	341	829	1141	688	669	640	471	541	427	341	341	341	682	625	568	341	723	807	890	973	1036
11	284	772	1084	631	612	583	130	541	427	341	284	284	625	568	511	511	666	750	833	916	979
12	227	715	1027	574	555	526	414	541	427	341	284	227	568	511	454	511	609	693	776	859	922
13	341	829	1141	688	669	640	755	739	768	682	625	568	341	341	341	852	723	807	890	973	1036
14	284	772	1084	631	612	583	698	682	711	625	568	511	341	284	284	795	666	750	833	916	979
15	227	715	1027	574	555	526	641	625	654	568	511	454	341	284	227	738	609	693	776	859	922
16	511	999	1311	858	839	810	925	513	399	341	511	511	852	795	738	400	893	977	1060	1143	1206
17	382	658	1182	729	710	681	796	780	809	723	666	609	723	666	609	893	382	445	528	611	674
18	466	210	1266	813	794	765	880	864	893	807	750	693	807	750	693	977	445	222	277	361	424
19	549	130	1349	896	877	848	963	947	976	890	833	776	890	833	776	1060	528	277	215	277	340
20	632	407	1432	979	960	931	1046	1030	1059	973	916	859	973	916	859	1143	611	361	277	222	256
21	695	470	1495	1042	1023	994	1109	1093	1122	1036	979	922	1036	979	922	1206	674	424	340	256	215

= Shows changes from the 2014 CLRP

Ref: I:\ateam\docum\FY16\2015CLRP\_Network\_Report\NW\_Report\_Tables\Bus Fare Matrix 2015.xls

Source: WMATA Tariff #33v2, effective July 1, 2014.

In addition to MFARE1 and MFARE2, there are two other Cube Voyager scripts that are used in fare development: Prefarv23.s, Metrorail\_Skims.s. The entire automated fare development process, consisting of all four programs is shown in Figure 3-31).

**Figure 3-31 Process for developing zone-to-zone transit fares**

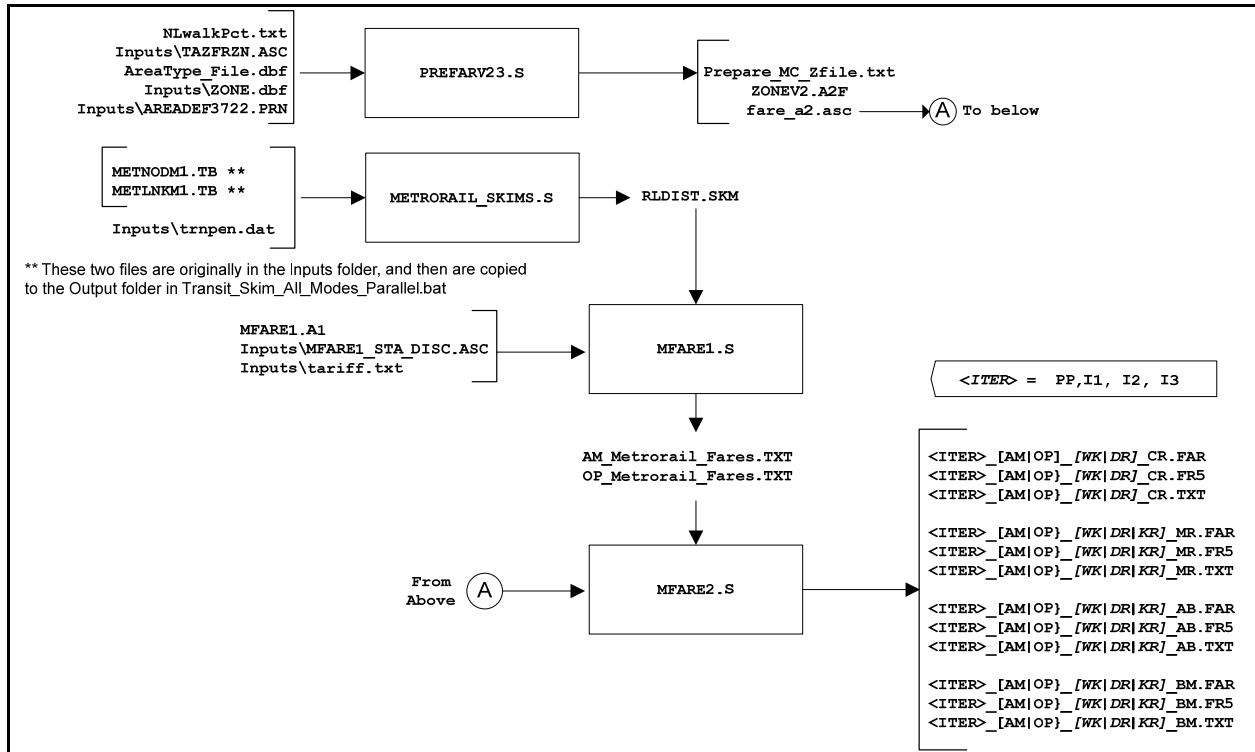

Source: Page A-12 of the User's Guide for the MWCOG/NC RTPB Travel Forecasting Model, Version 2.3, Build 57a. October 19, 2015

Ref: "I:\ateam\docum\fy14\2013CLRP\_Network\_Report\Ver2.3.52\_flowchart\_v2\_transit\_fares.vsd"

Ultimately, twenty-two fare matrices are developed by sub-mode, time period, and access type:

- Four sub-modes (Bus Only Metrorail only, Metrorail/ Bus, and Commuter Rail) by;
- Two time periods (AM, off-peak), by;
- Three access types (Walk, PNR, and KNR).

Since commuter rail access is distinguished by walk and auto access only (i.e., no differentiation between KNR and PNR), 22 matrices are developed (instead of the 24 implied above).

Table 3-37 lists the main transit fare input files. Chapter 18 of the Version 2.3.57a Travel Model User's Guide, dated October 19, 2015, also discusses the fare development process.

**Table 3-37 Listing of Transit Fare Input Files**

Filename	Description	Type	Source
tazfrzn.asc	Fare Zone File	Text	Analyst-generated
areadef3722.prn	Input TAZ-Mode choice district equivalence	Text	Analyst-generated
trnpen.dat	Metrorail network turn penalty file	Text	Analyst-generated
metlnkm1.tb	Metrorail links	Text	Geodatabase
metnodm1.tb	Metrorail nodes	Text	Geodatabase
mfare1_Sta_Disc.ASC	Metrorail Station fare discount array in cents	Text	Analyst-generated
tariff.txt	WMATA Transit fare (tariff) policy	Text	Analyst-generated
mfare1.a1	Metrorail station XYs scaled to 1/100ths of miles	Text	Geodatabase
BUSFARAM.ASC	AM bus fare matrix	Text	Analyst-generated
BUSFAROP.ASC	Off-peak bus fare matrix (same as AM)	Text	Analyst-generated

Ref: "\\cogfs002\ntp\$\ateam\docum\fy14\2013CLRP\_Network\_Report\v23\_inputs\_v10.xlsx"





## Chapter 4 COG/TPB Multi-Year, Multi-Modal Geodatabase

The network link and node inputs to the TPB travel model are maintained and managed in a multi-year, multi-modal spatial database, implemented as an ArcGIS geodatabase. The geodatabase interacts with a customized editing program, known as COGTools,<sup>31</sup> that runs within ArcGIS (Version 9.3). The program enables highway and network elements in the database to be viewed and edited interactively. This chapter provides some background on the geodatabase (GDB) design, structure and operation. The chapter also addresses how TPB staff utilizes digital, machine-readable transit information that is now publicly available to update and refresh the regional transit networks each year.

### 4.1 Geodatabase Overview and Editor

The TPB's transportation network geodatabase (GDB) serves as a central repository for highway and transit node and link data. It is currently prepared in Microsoft Access format as a personal geodatabase and stores network data in a multi-modal (highway and transit) and a multi-year framework. The geodatabase includes spatial/geographic information that allows network elements to be viewed and edited in the ArcGIS environment. The GDB also includes link attribute data that is required by the travel model. The use of a structured, time-series network database offers several key advantages that did not exist previously:

- Consistency in node and link geometry is enforced over time-series networks. Consistency in link attribute coding over time is also enforced.
- Transit network elements are integrated with highway elements in a relational database. Before the GDB existed, transit features were developed as independent text files that referenced the highway node system. The GDB combines transit and highway features so that they may be viewed (or mapped) as a complete system. The use of related tables has also enabled the dynamic linking of transit edits to occur as a result of highway editing.
- Consistency and accuracy of link screenline and jurisdiction codes are enforced over time. Before the GDB existed, screenline codes and jurisdiction codes were manually coded on highway links and subject to error and inconsistent coding from year to year. Using the GDB, screenlines and jurisdictional boundaries are represented as physical entities. The GDB then uses these physical entities and spatial operations to dynamically assign the appropriate jurisdiction and screenline code to each relevant link, thus reducing the likelihood of manual coding errors.
- The use of a geo-referenced database has greatly facilitated the incorporation of external data from partner agencies into the network development process. Most of the traffic counts, highway inventory data, observed speed data and transit routing information exists in some type of geo-referenced format.

---

<sup>31</sup> Li, Q., & Yin, J. (2013). COGTOOLS Draft User Guide, Revision 3.0. Washington, D.C.: Metropolitan Washington Council of Governments, National Capital Region Transportation Planning Board.

Some of the shortcomings of the current GDB approach include the following:

- Each network scenario is represented by a network year. This is generally not a problem, since the network year and network scenario are the same thing, but it means that one cannot easily represent two network scenarios that would occur in the same year.
- Edits to the highway network are reflected in the transit network, but only in a limited capacity.
- Although highway networks can be generated for any year between the base and horizon year, transit networks can be generated for only the designated milestone years.

The last two of these shortcomings are discussed in more detail later in the chapter.

TPB staff produces a new version of the multi-year GDB each year, such that it reflects latest version of the CLRP and TIP. The GDB is not developed from “scratch,” but rather, is typically developed using the GDB produced from the prior fiscal year (and the prior CLRP) as a starting point. A macro-scale view of the relationship between the GDB and the TPB travel model is shown in Figure 4-1. The figure indicates that the GDB development occurs in the ArcGIS environment.

**Figure 4-1 Relationship Between the GDB and the Cube Voyager Modeling Process**

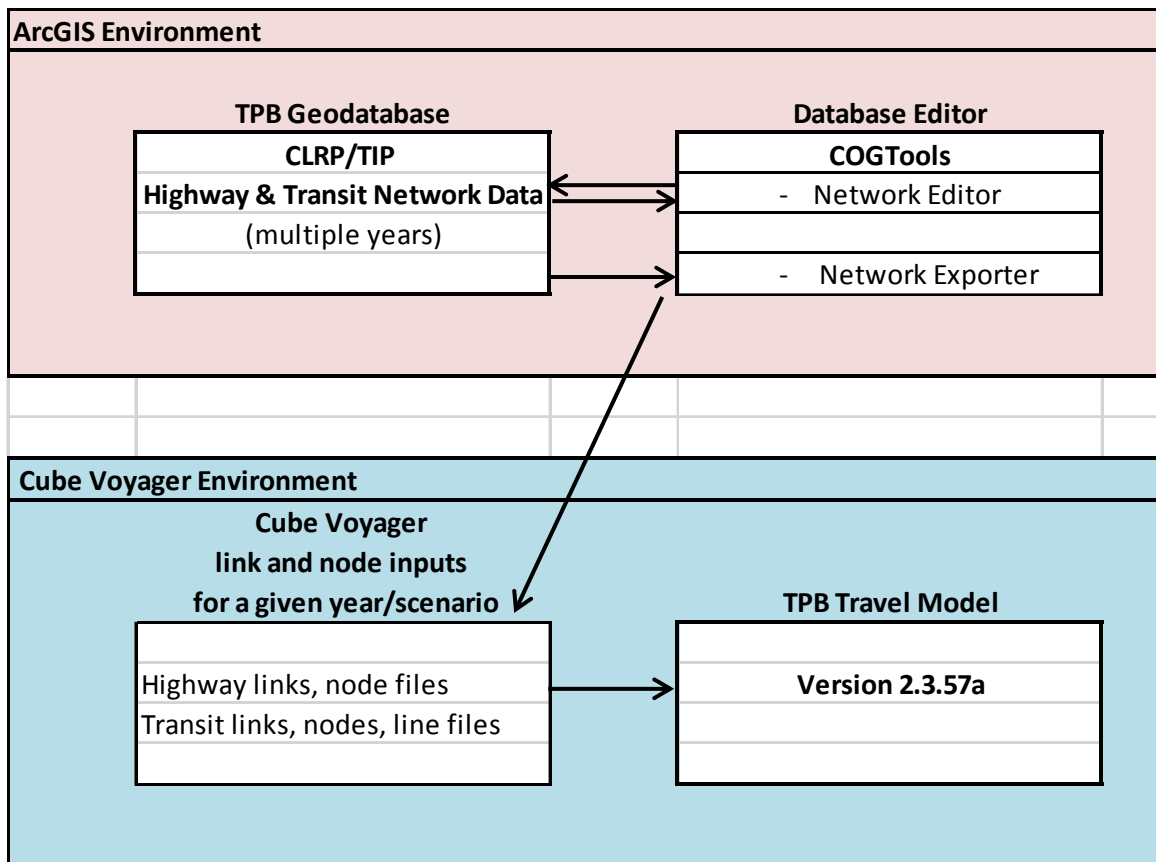

Ref: "I:\ateam\docum\FY16\2015CLRP\_Network\_Report\NW\_Report\_Tables\chapter4\_overview\_process.xlsx"

As shown in Figure 4-1, the GDB is maintained in ArcGIS and is not an integrated component of the travel modeling environment, which makes use of Citilabs Cube software and is normally launched from a Windows command prompt. The GDB interacts with a customized and interactive program editor named COGTools. The editor is applied as an added “tool bar” within the standard ArcGIS graphical user interface. The COGTools application includes two primary functions: 1) the ability to edit (add, delete or modify) network elements within the GDB and 2) the ability to export year-specific files from the GDB into to Cube Voyager-format files that are read directly into the travel model. The COGTools application also enables customized viewing and mapping of the highway and transit features in the GDB.

Before the current Esri geodatabase/COGTools approach, TPB staff used a “master” network stored in ArcInfo to manage the highway networks. In 2004, TPB staff invented a way to perform batch updates on link attributes such as facility type and number of lanes. This process was known as “TIPUP,” i.e., TIP update process. In 2009, this process was revised and re-named “PrepTIP,” i.e., prepare TIP batch update program.<sup>32</sup> Later, this TIPUP/PrepTIP process was updated to work with the geodatabase. TPB staff developed a suite of custom-designed, web-based forms that are tied to a back-end database, constructed by COG’s website contractor. TPB staff extracts the data using SQL Server Management Studio (personal correspondence, A. Austin, 1/27/16). Next the data is imported it into Microsoft Access to create our TIP and other reports. A few years ago, TPB staff reviewed some commercially available options, but they were mostly geared towards ranking and prioritizing projects, which was not what was needed for COG’s multi-jurisdiction/three-state situation. Note that the current process is not documented.

Following the batch update, manual edits are typically implemented to fine-tune network updates using the COGTools toolbar. Highway editing functions include the ability to:

- Add new facilities: Two approaches
  - Copy the link from a HERE/NAVTEQ street centerline file and add it to the geodatabase
  - Manually draw the link on the screen via a mouse or other similar pointing device
- Split highway links (insert a node within an existing highway link)
- Delete highway links
- Edit highway link attributes

The toolbar also include the following transit editing capabilities:

- Add a transit route
- Copy a transit route
- Delete a transit route
- Modify an existing transit route alignment (represented as a series of nodes)
- Edit transit route attributes

---

<sup>32</sup> Robert Snead, Charlene Howard, and Jane Posey, “Highway Network Database Batch Updates: PrepTIP Program,” Memorandum, March 11, 2009.

The COGTools design dynamically implements transit network changes in response to highway edits, albeit in a limited capacity. For example, when a highway network link is split, the affected transit route(s) are dynamically modified to include the added node within the existing route string.<sup>33</sup> However, if a highway network link is deleted, the affected transit route(s) are not modified, but the user is prompted to manually reconfigure the transit route. Also, only existing transit years in the geodatabase at the time of the highway edit are affected by transit edits. The transit editing tool is designed to identify transit routing errors, including discontinuities in the node string and cases where the transit route is coded in a manner that is inconsistent with the highway link directionality.

The current COGTools application treats highway network editing in a multi-year context. Highway and transit network edits are implemented with attention to a specific “year” attribute that exists on each link. The 2015 CLRP highway networks were prepared, for milestone years: 2015, 2017, 2020, 2025, 2030, and 2040. The COGTools editor allows for the generation of highway networks for *any year* between the base year and horizon year, respecting the edits implemented for each milestone year. Highway edits implemented for a given year, say 2020, will carry forth among networks for all years hence, including both milestone years and intermediate years. Transit networks, unlike highway networks, are developed individually for specific milestone years, so the database lacks the ability to propagate changes from one transit network to the next. However, all the transit years that are developed are stored together in the GDB.

The COGTools toolbar also allows for exporting year-specific files from the GDB to input files that are directly used by the travel model. The exporting process is performed separately for highway files and transit files. The highway export may be performed for any year and two formats may be selected:

- 1) *Cube Voyager input file* (link.dbf and node.dbf), or
- 2) *Personal geodatabase* (link and node feature classes).

The first format is designed to export network link and node files, in DBF file format, for any year specified by the user (i.e., any milestone or non-milestone year). The files exported comply with the input file format required by the Version 2.3.57a Travel Model. The second format may be used to export highway network line and point feature classes from the geodatabase and build a highway network (\*.net) in Cube Base, using the GIS tools module in Cube Base (“Build highway network from a feature class / shapefile”).

The highway exporting function includes the following features:

- It assigns link distances that reflect HERE/NAVTEQ centerline “true shape” lengths. Link distances are converted from feet to whole miles with an explicit decimal.
- It assigns jurisdiction codes to the highway network links based on the jurisdictional boundary shapes. Jurisdictional boundaries are included as a feature class in the

---

<sup>33</sup> This capability is also available in the Citilabs Cube Base graphical network editor, provided the user has both the highway and transit networks open at the same time.

network geodatabase. Highway links are associated with jurisdictions based on the midpoint of the link relative to jurisdictional boundaries.

- It assigns screenline codes to all highway network links that intersect the screenline feature class/layer that is contained in the network geodatabase.

The transit exporting function generates the full complement of year-specific transit link, node and route/line files for each transit year specifically included in the database. These are compliant with TPB's Version 2.3.57a travel model specifications.

## **4.2 Geodatabase Tables Overview**

A more detailed view of the tables that exist within the GDB structure is shown in Figure 4-2. The GDB is a collection of related MS Access tables that are of two general types: geometric network tables and logical network tables. The geometric network consists of two "feature class" tables: a network links table and a network nodes table. The two tables contain basic attributes of links and nodes in the transportation network, and geographic information that is necessary for displaying network features on a map. The network links attributes are shown in Table 4-1. The network node table attributes are shown in Table 4-2.

**Figure 4-2 TPB Geodatabase Structure**

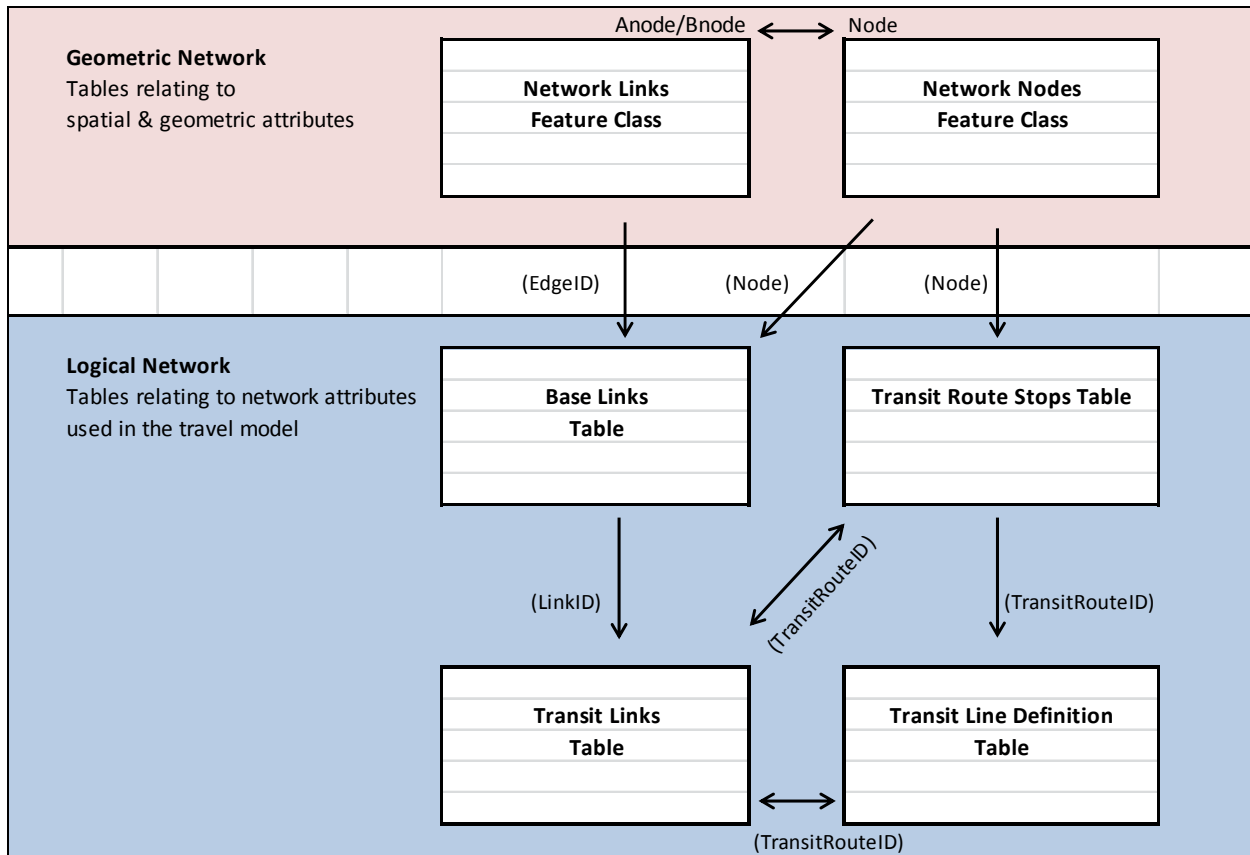

Ref: "I:\ateam\docum\FY16\2015CLRP\_Network\_Report\NW\_Report\_Tables\chapter4\_overview\_process.xlsx"

In contrast, the logical network is a group of tables that contain travel model-related attributes associated with the links and nodes. The logical network consists of four tables:

1. Base Links: Highway and transit network link attributes (see Table 4-3).
2. Transit Links: Transit network-related links (see Table 4-4).
3. Transit Route Stops: Transit route alignments, expressed as a network node sequence (see Table 4-5).
4. Transit Line Definition: The transit line attributes (see Table 4-6).

The highway network is composed of geometric elements from the network links and network node tables and logical network elements from the Baselinks table. The EdgeID variable in the network links table is a unique number that uniquely identifies each physical (geometric) link. It does not vary by direction or network year. As shown in Figure 4-2, the EdgeID is a primary key field that relates the geometric and logical highway networks. The relationship between the geometric network and the logical network is one to many (1:N). That is, each record/link in the geometric network (Network Link

feature class table) may correspond to zero, one, or many records/links in the logical network (Base Links table). Records/links in the logical network represent different network years.

In the logical network, LinkID is a unique number assigned to identify links by direction. It is a primary key variable that relates the logical network base links table and transit links table. The relationship between logical links and transit links is also one to many (1:N). That is, each logical network link may correspond to zero, one, or many transit links.

In the geometric network, the Network Nodes feature class mainly provides the geographic location of transportation facilities, such as transit stations, bus stops, park-and-ride lots, intersections, and zone centroids. Node is the unique numerical ID that relates the geometric network and the logical network, i.e., the nodes feature class table and the base links table.

**Table 4-1 Network Links Feature Class table with "Link Type" codes (1-16) description**

Field Name	Data Type	Description
OBJECTID	Long Integer	Geodatabase record identifier
Shape	N/A	Geodatabase geometry field
EdgeID	Long Integer	Geometry network link identifier
LinkType	Long Integer	Link type code: 1. Highway Link 2. Bus Link 3. TAZ Connector 4. Metrorail Link 5. Commuter Rail Link 6. Light Rail Link 7. Light Rail to Bus 8. Metro Station to Bus Stop 9. Commuter Station to Bus Stop 10. Metro PNR to Station 11. Commuter PNR to Station 12. Bus PNR to Bus Stop 13. Light PNR to Station 14. BRT/Street Link 15. BRT/Street PNR to Station 16. BRT/Street to Bus
ANode	Long Integer	A Node
BNode	Long Integer	B Node
FunctionClass	Long Integer	Link facility type code (0 - 6) 0/centroids, 1/Freeways, 2/Major Art., 3/Minor Art, 4/ Collector, 5/ Expressway, 6/ Ramp
Oneway	Integer	One-way or two-way link code: 1= two-way and 2= one-way
RampFlag	Text	(Not Used)
RouteID	Long Integer	(Not Used)
RouteName	Text	Facility name
UpdateBy	Text	Person's name updating the geodatabase
Screen	Long Integer	Screenline Code (1-38)
JUR	Integer	Jurisdiction code (0 -23): 0/dc, 1/mtg, 2/pg, 3/alr/, 4/alx,5, ffx, 6/ldn, 7/ pw, 8/(unused), 9/ frd, 10/how, 11/aa, 12/chs, 13/(unused), 14/car, 15/cal, 16/stm, 17/ kg, 18/fbg, 19/stf, 20/spts, 21/fau, 22/clk, 23/jef
Length	Double	Link Length in feet
Shape_Length	Double	ArcGIS auto-generated geometry length "true shape" in feet

Ref: "I:\ateam\docum\FY16\2015CLRP\_Network\_Report\NW\_Report\_Tables\gdb\_tables.xlsx"



**Table 4-2 Network Nodes Feature Class table with "Node Type" codes (1-13) description**

Field Name	Data Type	Description
OBJECTID	Long Integer	Geodatabase record identifier
Shape	N/A	Geodatabase geometry field
Node	Long Integer	Node numbers
NodeType	Long Integer	Node type code: 1= Highway Node 2= Bus Node 3= TAZ Centroid 4= Metrorail Node 5= Commuter Rail Node 6= Light Rail Node 7= Light Rail Parking Lot Node 8= Metro Parking Lot Node 9= Commuter Parking Lot Node 10= Bus PNR Node 11=BRT Street Node 12= BRT Street PNR 13= Station Dummy Centroid Node
Jur	Text	Jurisdiction code (0 - 23) <i>0/dc, 1/mtg, 2/pg, 3/alr/, 4/alx,5, ffx, 6/ldn, 7/ pw, 8/(unused), 9/ frd, 10/how, 11/aa, 12/chs, 13/(unused), 14/car, 15/cal, 16/stm, 17/ kg, 18/fbg, 19/stf, 20/spts, 21/fau, 22/clk, 23/jef</i>
UpdatedBy	Text	(Not Used)
X_COORD	Double	X coordinate of a node (MD State Plane, NAD83, feet)
Y_COORD	Double	Y coordinate of a node (MD State Plane, NAD83, feet)
Name	Text	TransitStop/Station Name
NetYear	Long Integer	The year the network node becomes active in the database

Ref: "I:\ateam\docum\FY16\2015CLRP\_Network\_Report\NW\_Report\_Tables\gdb\_tables.xlsx"

**Table 4-3 Base Links Table with "Mode" codes (1-16) description**

Field Name	Data Type	Description
OBJECTID	Long Integer	Geodatabase record identifier
LinkID	Long Integer	Logical network link Identifier
EdgeID	Long Integer	Geometry network link identifier
ANode	Long Integer	A Node
BNode	Long Integer	B Node
NDPR2	Text	Combination of Anode and Bnode (Not Used)
BaseYear*	Long Integer	Year 2000 or Year 2001
TravelDirection	Text	(Not Used)
Distance	Double	Link distance in miles (X.XX)
LinkType	Long Integer	Link type code (1-16)
Mode	Long Integer	Mode Code (1-16): 1= Local Metrobus 2= Express Metrobus 3= Metrorail 4= Commuter Rail 5= Light Rail 6= Other primary - Local bus 7= Other primary - Express bus 8= Other secondary - Local bus 9= Other secondary – Express bus 10= Bus Rapid Transit or Streetcar 11= Drive Access link 12= Bus-to-rail Transfer link 13= Walking link 14= (Not Used) 15= PNR-to-Rail station/Bus stop 16= Zonal Access or Egress
TOLL	Integer	Toll value in current year dollars
TollGrp	Long Integer	Toll Group code (1- 9999)
FType	Long Integer	Link facility type code (0 - 6) <i>0/centroids, 1/Freeways, 2/Major Art., 3/Minor Art, 4/ Collector, 5/ Expressway, 6/ Ramp</i>
LType	Text	Link type: <i>H=Highway links, T=Transit only links, and Z=TAZ</i>
AType	Long Integer	Area type code (1-6)
<Period> Lane	Long Integer	<Period> number of lanes
<Period> Limit	Long Integer	<Period> limit code (0 - 9)
Screen	Long Integer	Screenline code
NetYear	Long Integer	The year the network link becomes active in the database
ProjectID	Text	Project identifier
ZoneID	Long Integer	TAZ centroid identifier (1-3,722)
Status	Long Integer	Link status code: <i>1= Active and 2= Retired</i>
COGStatus	Text	(Not Used)
UpdateDate	Text	The date and time of link attributes update
Jur	Long Integer	Jurisdiction code (0 - 23) <i>0/dc, 1/mtg, 2/pg, 3/alr/, 4/alx,5, ffx, 6/dn, 7/ pw, 8/(unused), 9/frd, 10/how, 11/aa, 12/chs, 13/(unused), 14/car, 15/cal, 16/stm, 17/ kg, 18/fbg, 19/stf, 20/spts, 21/fau, 22/clk, 23/jef</i>
Count	Long Integer	(Not Used)
Speed	Double	(Not Used)
<b>Key</b>		
<Period> =	AM	AM peak period (6:00 9:59 AM)
	PM	PM peak period (3:00 - 7:00 PM)
	OP	Off-peak period (10:00 Am - 2:59 PM)
BaseYear*	2000	Links entered into the databasae by DCI when first developed
	2001	Links subsequently entered into the databasae by DTP staff

#### 4.2.1 Transit Network Tables

In the logical network, the transit network is represented by the following three tables:

1. Transit Links: Maintains the attributes of the transit network links.
2. Transit Route Stops: Consists of all transit connection points including bus stops, transit stations, and park-and-ride lots.
3. Transit Lines Definition: Contains year-specific transit data for each transit route.

The TransitRouteID variable is a primary key in the “Transit Line Definition” table and a foreign key in the “Transit Links” table and “Transit Route Stops” table. Thus, as shown in Figure 4-2, it links these three tables together. Attributes maintained in the Transit Links, Transit Route Stops, and Transit Lines Definition tables are shown in Table 4-4, Table 4-6, and Table 4-5, respectively.

**Table 4-4 Transit Links Table**

Field Name	Data Type	Description
ObjectID	Long Integer	Geodatabase record identifier
LinkID	Double	Logical network link identifier
TransitRouteID	Long Integer	Transit Route identifier
ANode	Double	A Node
BNode	Double	B Node
LinkSequence	Double	Sequence number of links that form a transit route
Scenario	Text	Project identifier
TransitYear	Double	Specific year of the transit route
SYear	Double	Year project is open for use
Operation	Double	Operation time code: 1= AM peak and 2= off-peak

Ref: "I:\ateam\docum\FY16\2015CLRP\_Network\_Report\NW\_Report\_Tables\gdb\_tables.xlsx"

**Table 4-5 Transit Route Stops Table**

Field Name	Data Type	Description
ObjectID	Long Integer	Geodatabase record identifier
TransitRouteID	Long Integer	Transit Route identifier
Node	Long Integer	List of nodes used by a transit route
NodeSequence	Long Integer	Sequence number of nodes on a specific transit route
Operation	Long Integer	Transit operation period code: 1= AM peak (7:00AM - 7:59 AM) and 2= off-peak (10:00AM-2:59PM)
StopFlag	Integer	Transit stop or non-stop code: 0= Stop and 1= Non-Stop
SourceYear	Long Integer	Base year from which transit route is derived
SYear	Long Integer	Year project is open for use
Scenario	Text	Project identifier
TransitYear	Long Integer	Specific year of the transit route

**Table 4-6 Transit Lines Definition Table**

Field Name	Data Type	Description
ObjectID	Long Integer	Geodatabase record identifier
TransitRouteID	Long Integer	Transit Route identifier
TransitRouteName	Text	Transit Route name
OriginNode	Long Integer	Origin-of-transit-route stop node identifier
DestinationNode	Long Integer	End-of-transit-route stop node identifier
OriginNodeName	Text	Origin transit line station name e.g. Shady Grove Station
DestiNodeName	Text	End-of-the line station name e.g. Glenmont Station
Oneway	Long Integer	One-way or two-way route code: 1= two-way and 2= one-way
Mode	Long Integer	Mode Code: 1= Local Metrobus 2= Express Metrobus 3= Metro Rail 4= Commuter Rail 5= Light Rail 6= Other primary - Local bus 7= Other primary - Express bus 8= Other secondary - Local bus 9= Other secondary – Express bus 10= Bus Rapid Transit or Streetcar 11= Drive Access link 12= Bus-to-rail Transfer link 13= Walking link 14= (Not Used) 15= PNR-to-Rail station/Bus stop 16= Zonal Access or Egress
Headway	Double	Transit vehicle headway (in mins.)
Runtime	Long Integer	Transit route running time (in mins.)
Operation	Long Integer	Transit operation period code: 1= AM peak (7:00 AM -7:59 AM) and 2= off-peak (10 AM-2:59 PM)
SourceYear	Long Integer	Base year from which transit route is derived
Scenario	Text	Project identifier
TransitYear	Long Integer	Specific year of the transit route
SYear	Long Integer	Year project is open for use
RunSpeed	Long Integer	(Not Used)
LineDistance	Long Integer	(Not Used)
Operator	Text	Transit operator / owner name, e.g. WMATA

Ref: "I:\ateam\docum\FY16\2015CLRP\_Network\_Report\NW\_Report\_Tables\gdb\_tables.xlsx"

### 4.3 General Transit Feed Specification (GTFS) Data

One of the standard procedures in the annual network development process is an update of the base-year transit network line files. The base-year transit network is the starting point for developing all the future-year transit networks. The update generally involves:

- 1) Ensuring that the transit lines reflect the most up-to-date run times and service frequencies.
- 2) Checking on whether or not individual transit lines have been added or removed.

In the past, the update was done using the paper route schedules published by the transit operators. In the late 1990s, the larger transit operators, such as WMATA and Ride-On, provided some digital, machine-readable schedule data that could be used to calculate average run times and frequencies (headways) for each of the two time-of-day periods (peak and off peak).<sup>34 35</sup> In 2005, Google and Portland's TriMet transit agency developed an electronic data format for incorporating transit data into online maps. The format was initially known as "Google Transit Feed Specification" (GTFS). Over the next few years, this standard became the default format for sharing public transit scheduling information, and later, the name was changed to "General Transit Feed Specification" (also GTFS). A GTFS feed is a collection of comma-separated (CSV) files that represents a public transit system's schedules and transit route itineraries. Each file contains a particular aspect of transit service, including stops, routes, trips, and other schedule data. The GTFS specification is defined by the series of files shown in Table 4-7.

Currently, COG staff makes use of both the machine-readable, digital data from GTFS and paper schedules (or PDF files from transit operator websites), when the GTFS data is not available. Given the manual effort involved, the transit line updating process has generally been one of the more onerous tasks in the network development area.

---

<sup>34</sup> Mark S. Moran, "Using Electronic Files from WMATA to Calculate Average Headways and Run Times for 1998 WMATA Bus Service," Internal Report (Washington, D.C.: Metropolitan Washington Council of Governments, February 18, 1999).

<sup>35</sup> Mark S. Moran, "Fall 1999 Ride On Bus Schedule Data: Using SAS to 1) Calculate Average Headways and Run Times and 2) Determine Which Routes Are Eligible for Coding as Two-Way Routes," Internal Report (Washington, D.C.: Metropolitan Washington Council of Governments, October 20, 1999), Box: Old project files, ca. 1995.

**Table 4-7 GTFS files**

Filename		
<u>agency.txt</u>	Required	One or more transit agencies that provide the data in this feed.
<u>stops.txt</u>	Required	Individual locations where vehicles pick up or drop off passengers.
<u>routes.txt</u>	Required	Transit routes. A route is a group of trips that are displayed to riders as a single service.
<u>trips.txt</u>	Required	Trips for each route. A trip is a sequence of two or more stops that occurs at specific time.
<u>stop_times.txt</u>	Required	Times that a vehicle arrives at and departs from individual stops for each trip.
<u>calendar.txt</u>	Required	Dates for service IDs using a weekly schedule. Specify when service starts and ends, as well as days of the week where service is available.
<u>calendar_dates.txt</u>	Optional	Exceptions for the service IDs defined in the calendar.txt file. If calendar_dates.txt includes ALL dates of service, this file may be specified instead of calendar.txt.
<u>fare_attributes.txt</u>	Optional	Fare information for a transit organization's routes.
<u>fare_rules.txt</u>	Optional	Rules for applying fare information for a transit organization's routes.
<u>shapes.txt</u>	Optional	Rules for drawing lines on a map to represent a transit organization's routes.
<u>frequencies.txt</u>	Optional	Headway (time between trips) for routes with variable frequency of service.
<u>transfers.txt</u>	Optional	Rules for making connections at transfer points between routes.
<u>feed_info.txt</u>	Optional	Additional information about the feed itself, including publisher, version, and expiration information.

GTFS information in the Washington, D.C. region is available for about 87% of the existing transit routes. As shown in Table 4-8, 15 of the 27 transit service providers included in the regional transit network currently post GTFS information.

**Table 4-8 Availability of GTFS data for transit operators in the Washington, D.C. area**

Seq. No.	Transit Providers	GTFS Data	Paper Schedule
1	WMATA	x	
2	Arlington County	x	
3	Bethesda Circulator		X
4	City of Alexandria	x	
5	Calvert County		X
6	Charles County		X
7	Fairfax City	X	
8	Fairfax County	x	
9	Falls Church	x	
10	Frederick County	x	

<b>Seq. No.</b>	<b>Transit Providers</b>	<b>GTFS Data</b>	<b>Paper Schedule</b>
11	Fredericksburg Feeder Bus to VRE		X
12	Greater Springfield Transit		X
13	Howard County	x	
14	City of Laurel	x	
15	Lee Coaches Commuter Bus		X
16	Loudoun County	x	
17	Maryland MTA	x	
18	Montgomery County	x	
19	National Coach Commuter Bus (Fredericksburg, Spotsylvania & Stafford Counties)		X
20	OMNI-LINK (Prince William County)	x	
21	OMNI-RIDE (Prince William County Commuter Bus)	x	
22	Prince George's County	x	
23	Quicks Commuter Bus (Fredericksburg, Spotsylvania & Stafford Counties)		X
24	Rex Bus		X
25	St. Mary's County		X
26	Tyson's Circulator		X
27	Washington Flyer- Dulles/WFC		X
	Total	15	12

TPB staff downloads GTFS data directly from the primary transit providers or from the GTFS Data Exchange website (<http://www.gtfs-data-exchange.com/>) each fall. Once GTFS data are ready, TPB staff has developed an automated database procedure to convert these text files into Microsoft Access database tables and compute average transit route run times and average route headways by time-of-day period. The automated database procedure also extracts geometric (route itinerary) information. The procedure for processing GTFS data is shown in Figure 4-3.

Figure 4-3 Process for combining GTFS data into the COG Geodatabase

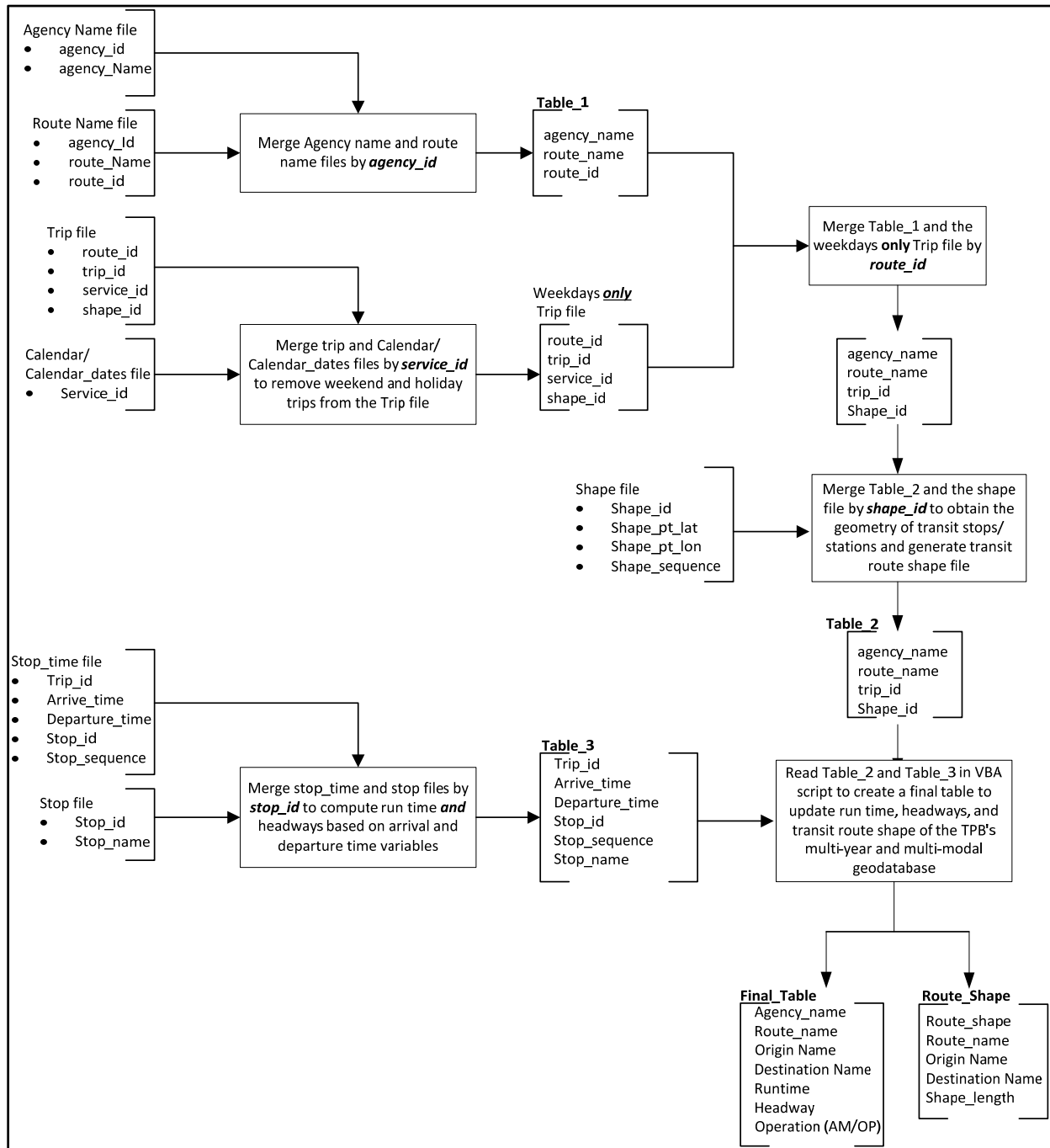

Ref: "I:\ateam\docum\FY16\2015CLRP\_Network\_Report\GTFS\_Data\_Process\_Flowchart.docx"

After the GTFS data are added to the GDB, transit service from providers which do not use GTFS is coded into the GDB using schedule information from each provider's website. This completes the base-year transit network files upon which all forecast-year transit network files are built.