

Item #4
Commuter Connections
Subcommittee Meeting
May 18, 2010

2010
CONGESTION MANAGEMENT PROCESS (CMP)
TECHNICAL REPORT

DRAFT

April 30, 2010

Please submit your comments and/or questions by **May 28** to COG/TPB staff
Wenjing Pu at wpu@mwcog.org, 202-962-3329 (Phone), or 202-962-3202 (Fax)

National Capital Region Transportation Planning Board
Metropolitan Washington Council of Governments

The preparation of this report was financially aided through grants from the District of Columbia Department of Transportation; Maryland Department of Transportation; Virginia Department of Transportation; U.S. Department of Transportation, Federal Highway Administration; and the U.S. Department of Transportation, Federal Transit Administration, under the Federal Transit Act. The material herein does not necessarily reflect the views of the sponsoring agencies.

TITLE: 2010 Congestion Management Process (CMP) Technical Report (DRAFT)	Date: May 2010
	Number of Pages: 237
AUTHORS: Wenjing Pu, Metropolitan Washington Council of Governments Andrew J. Meese, AICP, Metropolitan Washington Council of Governments	
AGENCY: The Metropolitan Washington Council of Governments (COG) is the regional organization of the Washington area's major local governments and their governing officials. COG works toward solutions to such regional problems as growth, transportation, the environment, economic development, and public safety. The National Capital Region Transportation Planning Board (TPB) conducts the continuing, comprehensive transportation planning process for the National Capital Region under the authority of the Federal-Aid Highway Act of 1962, as amended, in cooperation with the states and local governments.	
ABSTRACT: This report provides technical details and documents the Congestion Management Process in the National Capital Region. It contains updated congestion information and congestion management strategies on the region's transportation systems, as well as the process integrating the Congestion Management Process into the region's Financially Constrained Long-Range Transportation Plan.	
ORDER COPIES FROM: Metropolitan Information Center Metropolitan Washington Council of Governments 777 North Capitol Street, NE, Suite 300 Washington, D.C., 20002-4290 (202) 962-3256 Electronic copy of this report can be found on the MWCOG website: [URL to be added]	

COG/TPB Staff

Wenjing Pu
Transportation Planner

Andrew J. Meese
Systems Management Planning Director

* * *

Technical Oversight

Transportation Planning Board Technical Committee
with
Management, Operations, and Intelligent Transportation Systems (MOITS) Policy Task Force
and MOITS Technical Subcommittee
Travel Management Subcommittee
Commuter Connections Subcommittee
Travel Forecasting Subcommittee

Acknowledgements

[to be added]

TABLE OF CONTENTS

EXECUTIVE SUMMARY	7
<i>Background.....</i>	<i>7</i>
<i>Components of the CMP.....</i>	<i>7</i>
<i>Congestion on Freeways.....</i>	<i>7</i>
Congestion Monitoring	7
State of Congestion	9
Top Bottlenecks	10
Future Congestion	12
Travel Time Reliability	12
<i>Congestion on Arterials.....</i>	<i>12</i>
Congestion Monitoring	12
State of Congestion	12
Traffic Signal Timing.....	13
<i>Congestion on Transit and Other Systems.....</i>	<i>13</i>
Transit	13
Park-and-Ride Facilities.....	14
Airport Access.....	14
Freight.....	14
<i>National Comparison of the Washington Region’s Congestion.....</i>	<i>15</i>
<i>Congestion Management Strategies</i>	<i>15</i>
Demand Management Strategies.....	15
Operational Management Strategies	16
Capacity Increase Projects	16
<i>Assessment of Congestion Management Strategies</i>	<i>16</i>
Assessment of Implemented Strategies.....	16
Assessment of Potential Strategies.....	17
<i>Compiling Project-Specific Congestion Management Information.....</i>	<i>18</i>
<i>Congestion Management as a Process in the CLRP.....</i>	<i>19</i>
<i>Key Findings of the 2010 CMP Technical Report.....</i>	<i>19</i>
<i>Recommendations for the Congestion Management Process.....</i>	<i>20</i>
MAIN REPORT	23
1. INTRODUCTION	23
1.1 Need for a CMP Technical Report.....	23
1.2 The Institutional Context of the CMP in the Washington Region	24
1.3 Coverage Area of the CMP.....	25
1.4 Components of the CMP.....	26
1.5 Highlights of the 2010 Update of the CMP Technical Report.....	26
2. STATE OF CONGESTION.....	29
2.1 Congestion of the Metropolitan Area’s Major Highways.....	29
2.1.1 TPB Freeway Congestion Monitoring	29
2.1.2 TPB Arterial Congestion Monitoring.....	41
2.1.3 I-95 Corridor Coalition Traffic Monitoring	48
2.2 Safety and Congestion	65
2.2.1 Overview	65
2.2.2 Traffic Safety Facts	66
2.2.3 Incident-Related and Non-Recurring Congestion	67
2.3 Congestion on the Metropolitan Area’s Transit Systems.....	68
2.3.1 Impacts of Highway Congestion on Transit Systems.....	68
2.3.2 Congestion within Transit Facilities or Systems.....	68

2.4	<i>Park-and-Ride Facilities</i>	70
2.5	<i>Airport Access</i>	72
2.6	<i>Freight Movement and Congestion</i>	73
2.7	<i>Other Congestion Monitoring and Data Consolidation Activities</i>	76
2.7.1	Cordon Counts	76
2.7.2	Household Travel Surveys	78
2.7.3	Special Surveys and Studies [To Be Updated].....	79
2.7.4	The Regional Transportation Data Clearinghouse	81
2.7.5	FHWA TTID Program Traffic Monitoring	82
2.8	<i>National Comparison of the Washington Region’s Congestion</i>	82
2.9	<i>Performance and Forecasting Analysis of the 2009 Financially Constrained Long-Range Transportation Plan (CLRP)</i>	84
3.	CONSIDERATION AND IMPLEMENTATION OF CONGESTION MANAGEMENT STRATEGIES	89
3.1	<i>Overview of Demand Management and Supply Management</i>	89
3.2	<i>Demand Management Strategies</i>	89
3.2.1	Commuter Connections Program	89
3.2.2	Local and Other Transportation Demand Management and Traffic Management Activities	94
3.2.3	Transit Systems	105
3.2.4	Pedestrian and Bicycle Transportation.....	106
3.2.5	Car Sharing	108
3.2.6	Land Use Strategies in the Washington Region [To Be Updated]	108
3.3	<i>Operational Management Strategies</i>	112
3.3.1	High-Occupancy Vehicle (HOV) Facilities	112
3.3.2	Variably Priced Lanes/Systems [To Be Updated].....	116
3.3.3	Traffic Management.....	118
3.4	<i>Additional System Capacity</i>	124
3.4.1	Documentation of Congestion Management for Additional System Capacity.....	124
3.4.2	Where Additional System Capacity Is Needed and How the Additional System Capacity Will be Managed Efficiently	124
3.5	<i>Project-Related Congestion Management [To Be Updated]</i>	125
3.5.1	Woodrow Wilson Bridge	125
3.5.2	I-95/I-495 Springfield Interchange.....	126
3.5.3	11th Street Bridges.....	127
3.5.4	South Capitol Street Project.....	127
3.5.5	Northern Virginia Congestion Management Program During Construction.....	127
4.	STUDIES OF CONGESTION MANAGEMENT STRATEGIES	129
4.1	<i>Review of Performance Measures</i>	129
4.1.1	Introduction to Performance Measures	129
4.1.2	How Performance Measures/Indicators Were Selected	129
4.1.3	Selected CMP Performance Measures	130
4.2	<i>Review of Congestion Management Strategies</i>	133
4.2.1	Introduction.....	133
4.2.2	Descriptions of Strategies	134
4.3	<i>Examples of Strategies Studies</i>	137
4.3.1	Analysis of Transportation Emissions Reduction Measures (TERMs).....	137
4.3.2	Regional Mobility and Accessibility Scenario Study – Phase I	138
4.3.3	Regional Mobility and Accessibility Scenario Study – Phase II.....	140
4.3.4	MATOC Benefit-Cost Analysis	141
4.3.5	MOITS Strategic Plan	141
5.	HOW RESULTS OF THE CMP ARE INTEGRATED INTO THE CLRP	142
5.1	<i>Components of the CMP Are Integrated in the CLRP</i>	142

5.2 Demand Management in the CLRP	143
5.3 Operational Management in the CLRP	143
5.4 Capacity Increases in the CLRP and Their CMP Components	144
6. CONCLUSIONS.....	145
6.1 Key Findings of the 2010 CMP Technical Report	145
6.2 Recommendations for the Congestion Management Process	146
APPENDICES.....	148
Appendix A – Significant Changes from 2005 to 2008 Freeway Aerial Surveys	149
Appendix B – Results of FY 2008 and FY 2009 Arterial Studies	164
Appendix C – Travel Time Index of the I-95 Corridor Coalition Vehicle Probe Project Covered Highways in the TPB Member Jurisdictions	177
Appendix D – Planning Time Index of the I-95 Corridor Coalition Vehicle Probe Project Covered Highways in the TPB Member Jurisdictions	191
Appendix E – Buffer Time Index of the I-95 Corridor Coalition Vehicle Probe Project Covered Highways in the TPB Member Jurisdictions	205
Appendix F – SHA Ridesharing Facility Statistics.....	219
Appendix G – 2006 Central Employment Area Cordon Count Graphic	220
Appendix H – 2003 DC Cordon Count Study Graphic	221
Appendix I – Summary of Daily Impact Results for Individual TERMS (7/05– 6/08) and Comparison to Goals	222
Appendix J – Peak Direction Travel Time Summary for HOV and non-HOV Lanes.....	223
Appendix K – Sample CMP Documentation Form	224
Appendix L – Review of Congestion Management Strategies	226

EXECUTIVE SUMMARY

Background

A Congestion Management Process (CMP) is a requirement in metropolitan transportation planning from both the 2005 federal SAFETEA-LU transportation legislation and its supporting metropolitan planning regulations. These regulations were a basis for the CMP components that are wholly incorporated in the region's Constrained Long-Range Plan (CLRP) for transportation. The CMP component of the CLRP constitutes the region's official CMP, and serve to satisfy the SAFETEA-LU requirement of having a regional CMP.

This CMP Technical Report serves as a background document to the official CLRP/CMP, providing detailed information on data, strategies, and regional programs involved in congestion management. This 2010 CMP Technical Report is an updated version of the previously published 2008 CMP Technical Report.

Components of the CMP

The National Capital Region's Congestion Management Process has four components as described in the CLRP:

- Monitor and evaluate transportation system performance
- Define and analyze strategies
- Implement strategies and assess
- Compile project-specific congestion management information

This report documents and provides technical details of the four components of the CMP. It compiles information from a wide range of metropolitan transportation planning activities, as well as providing some additional CMP specific analyses, particularly travel time reliability and non-recurring congestion analyses.

Congestion on Freeways

CONGESTION MONITORING

The National Capital Region's freeway monitoring program is mainly based upon a comprehensive aerial photography survey of the region's freeway system conducted by Skycomp, Inc. AM and PM peak periods congestion is monitored once every three years since 1993 and the most recent survey was conducted in [Spring 2008](#).

In addition to the aerial photography program, since July 1, 2008, a number of the region's freeways (198 centerline miles, as shown in [Figure 1](#)) have also been covered by and data made available through the [I-95 Corridor Coalition's Vehicle Probe Project](#). The two most significant advantages of this new innovative data source are that it provides continuous (24/7/365) monitoring, and that it reports segment-based speeds and travel times, which are more accurate

STATE OF CONGESTION

From 2005 to 2008, vehicle miles of travel (VMT) fell 3.1 percent nationally and in DC, Maryland and Virginia. This was the first time since the Skycomp aerial surveys began in 1993 that VMT had dropped since the previous survey. Accordingly, total lane miles with LOS F congestion in the AM and PM peak periods² dropped by 24 percent from 2005 to 2008, almost back to 2002 levels, as shown on the left in **Figure 2**.

Figure 2: Year-to-Year Congestion Variation

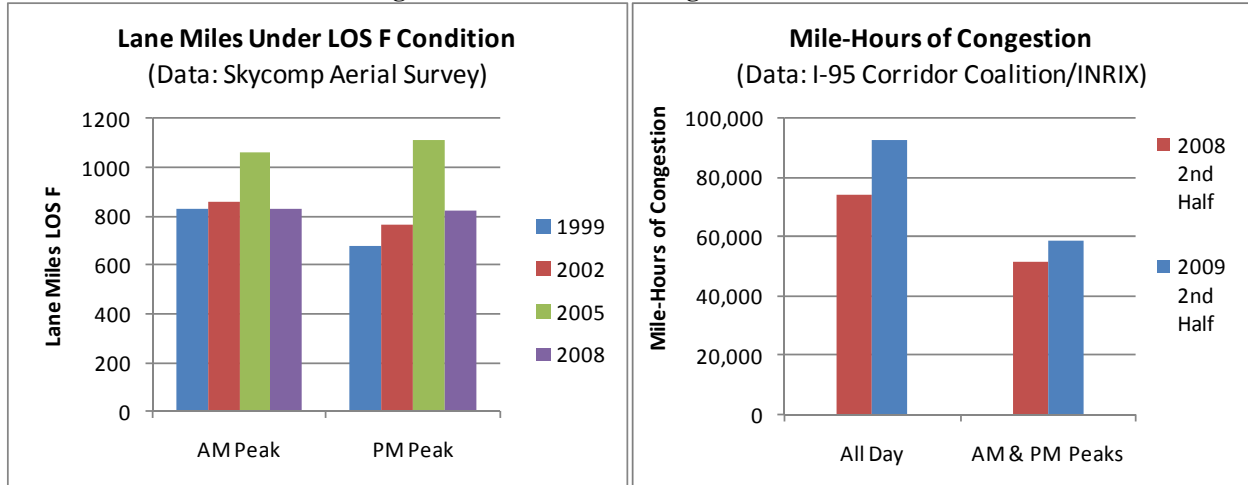

Since then, evidence has been found that the congestion trend has started increasing again from the second half of 2008 to the second half of 2009. The I-95 Corridor Coalition/INRIX data observed a 14 percent increase of mile-hours of congestion for AM and PM peak periods and 24 percent increase for all day³ – faster increase in non-rush hours – as shown on the right in **Figure 2 and Figure 3**. Non-holiday workday peak periods congestion accounted for about 60-70 percent of all day all time congestion in both years.

Figure 3: Month-to-Month Congestion Variation

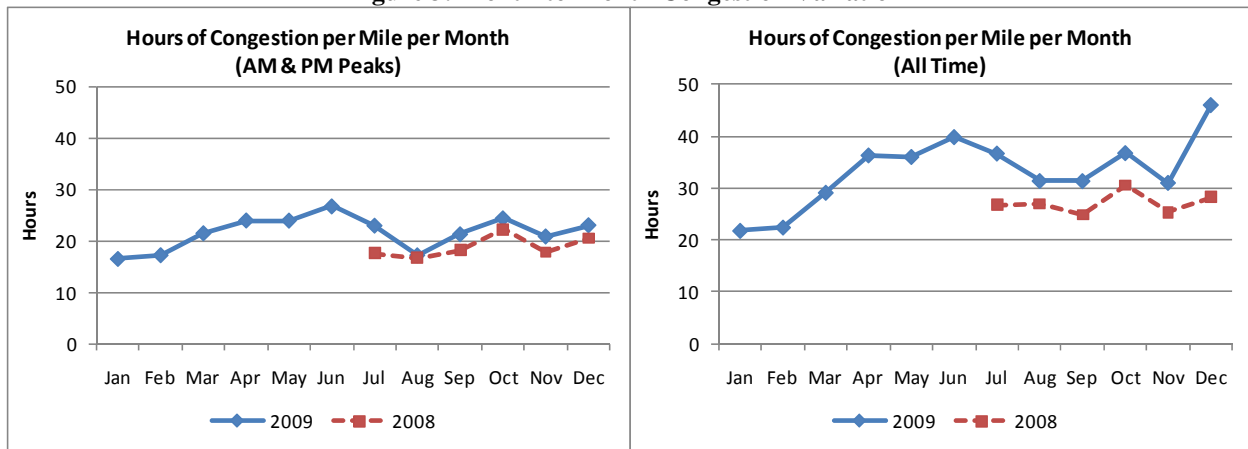

² The AM peak was 6:00-9:00 AM outside the Capital Beltway and 6:30-9:30 AM inside the Capital Beltway. The PM peak was 4:00-7:00 PM inside the Capital Beltway and 4:30-7:30 PM outside the Capital Beltway.

³ “Congestion” is considered if speed is not higher than 50 percent of free-flow speed. “AM & PM Peaks” cover 4 hours in the morning (6:00-10:00 AM) and 4 hours in the afternoon (3:00-7:00 PM) for non-holiday workdays, and “All Day” covers 24 hours a day and all days. Note the Coalition’s data do not cover I-270 and freeways in Frederick County, Maryland.

Congestion varies month to month, as illustrated by hours of congestion per mile for all the I-95 Corridor Coalition/INRIX covered freeways in the region (Figure 3). In the first half of 2009, congestion generally kept increasing from the least in January to the worst in June; in the second half, there were some fluctuations with July, October and December generally having worse congestion than August, September and November. The sharp jump in December 2009 “All Time” congestion was largely attributed to the December 19 (Saturday) snow storm that affected the following week’s travel.

Congestion also varies among different time of day and day of week, as illustrated by travel time index – the ratio of actual travel time over free flow travel time – in Figure 4 using all 2009 INRIX data. Tuesday mornings and Friday afternoons were the busiest AM and PM peak periods. Friday 4:00-5:00 PM remained the most congested hour of the week and Tuesday 8:00-9:00 AM remained the most congested morning rush hour. For the same workday, the morning peak hour was less congested than the evening peak hour. Friday evening peak hour (4:00-5:00 PM) was one hour earlier than the peak hour (5:00-6:00 PM) observed in the other four workdays. Finally, Saturday had more traffic than Sunday, but both weekend days were generally less congested than workdays, especially during peak periods.

Figure 4: Time of Day and Day of Week Congestion Variation

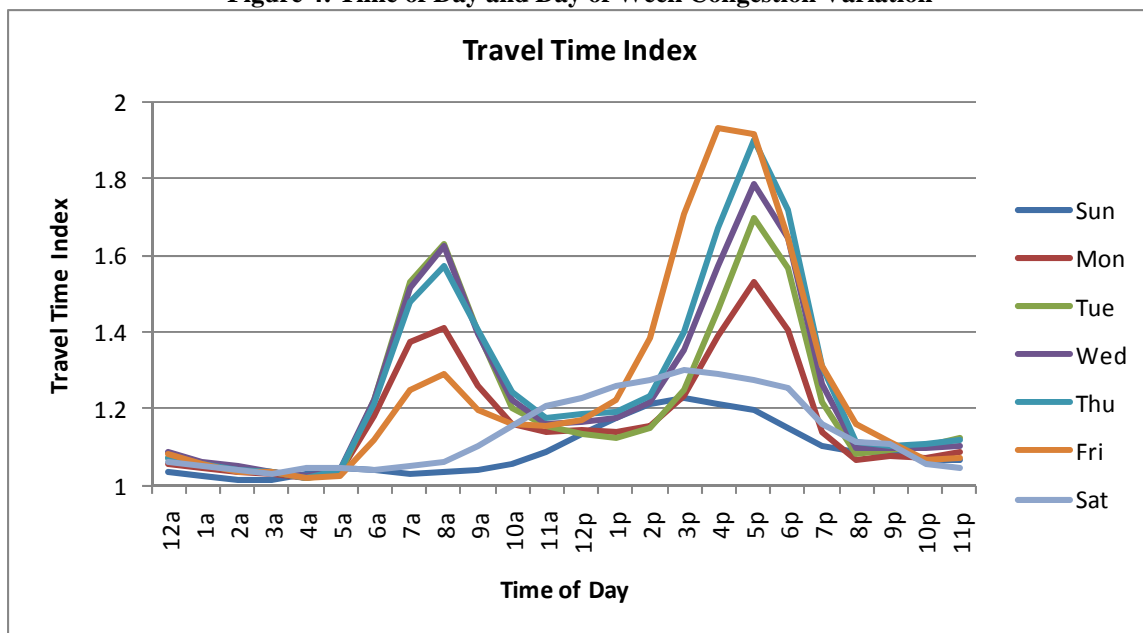

TOP BOTTLENECKS

Based on the number of vehicles per lane per mile (i.e., density of traffic flow), the Spring 2008 Skycomp survey identified the top ten most congested locations in the region, as listed in Table 1. Based on travel time index (the ratio of actual travel time over free flow travel time) and the number of congested hours, the I-95 Corridor Coalition/INRIX data also identified the top 25 most congested bottlenecks for the INRIX data covered freeways in the region. Seven of the 25 top bottlenecks are already listed by the Skycomp survey, and the rest of 18 bottlenecks are provided in Table 2 and merit further investigation for improvements.

Table 1: Top Ten Most Congested Locations Identified by Skycomp Spring 2008 Survey

Rank	Road/Direction	Segment/Interchange	Density	Speed Range (MPH)
1	I-395 SB	4th St -- US-1	115	10-15
2	11th St Bridge WB	I-295 -- Southeast Fwy	110	10-15
3	I-395 NB	11th St --Pennsylvania Ave	105	12-20
4	I-495 OL	MD-650 --US-29	100-105	12-20
5A	I-495 IL	VA-193 -- GW Pkwy	100	14-20
5B	I-395 NB	US-1 -- 12th St	100	14-21
5C	I-66 HOV EB	VA-243 -- I-495	100	14-22
5D	I-66 EB	VA-267 -- Westmoreland St	100	14-23
5E	I-495 IL	MD-187 -- MD-355	100	14-24
5F	I-95 NB	VA-644 -- I-495	100	14-25

Table 2: Additional (to the Skycomp Survey) Most Congested Locations Identified by INRIX 2009 Data

Rank	Road/Direction	Segment/Interchange	Length (miles)	Hours of Congestion in A Week	Average Speed when Congested (mph)
1	I-95 HOV SB	VA-234/EXIT 152 -- I-95 MERGE	0.68	31	18
3	I-95 SB	VA-234/DUMFRIES RD/EXIT 152	0.63	32	20
4	I-95 NB	VA 3000/EXIT 158 -- VA-642/EXIT 163	5.49	35	22
5	I-66 WB	VA-234/PR WM PKWY/EXIT 44	0.41	27	17
6	MD-295 NB	I-495 -- POWDER MILL RD	4.18	30	21
7	I-95/I-395 SB	I-495 -- VA-7100/EXIT 166	5.29	28	20
8	I-95 SB	US-1/EXIT 161 -- VA-123/EXIT 160	1.60	32	23
11	I-95 SB	VA-619/JOPLIN RD/EXIT 150	1.90	27	21
12	I-66 EB	VA-243/EXIT 62 -- I-495/EXIT 64	3.11	22	17
14	I-395 HOV NB	EADS ST -- MEMORIAL BRIDGE	1.58	27	20
15	I-495 IL	US-50/ARLINGTON BLVD/EXIT 50	0.67	26	22
16	I-495 IL	VA-267/EXIT 45	0.51	20	17
18	I-66 WB	VADEN DR/EXIT 62	0.67	24	22
19	VA-267 EB	I-66	1.94	20	18
20	I-95 SB	DALE BLVD/EB EXIT 156	1.99	18	18
22	I-495 OL	VA-123/EXIT 11	0.70	20	19
24	I-495 IL	CABIN JOHN PKWY -- MD-190	0.46	16	16
25	I-95 HOV NB	VA-7900/EXIT 169	0.44	20	23

FUTURE CONGESTION

The CLRP [travel demand modeling forecasts](#) provide information on future congestion locations. Portions of I-495 in Maryland and Virginia (mostly south Beltway) experiencing generally free-flow conditions in 2008 evening peak period would experience more moderate congestion in 2030. In addition, some areas with moderate congestion, such as on a portion of I-66 and Dulles Toll Road in Virginia, I-95 and MD-295 in Maryland, would experience severe congestion in the future. While it is evident that congestion may be getting worse in some areas by 2030, this is not true for all areas. Improvement is also evident, such as around the I-95 high occupancy/toll (HOT) lanes in Virginia and I-270 in Maryland.

The existing conditions and future forecasts provides an overall picture of current and future congestion in the region, and helps set the stage for agencies to consider and implement CMP strategies, including those integrated into capacity-increasing roadway projects.

TRAVEL TIME RELIABILITY

Leveraged by the I-95 Corridor Coalition/INRIX data, travel time reliability has been examined in the CMP for the first time. Travel time reliability is a consistency or dependability in travel times, as measured from day to day or across different times of day⁴. It considers both recurring congestion and non-recurring congestion and provides travelers the amount of time needed to be budgeted to ensure on-time arrivals most of the time. In line with the increase of congestion, travel time reliability deteriorated 13 percent for both peak periods and all day from the second half of 2008 (with its historically high fuel prices contributing to reduced congestion) to the second half of 2009.

Congestion on Arterials

CONGESTION MONITORING

The TPB's arterial monitoring program is carried out by staff using global positioning system-equipped floating vehicles⁵. 57 major arterial routes totaling 429 miles in the region are currently monitored on a three-year cycle with each year monitoring about one third of them (e.g., FY⁶ 2003 routes repeated in FY 2006, and FY 2009, etc.). Field data collections are usually conducted during Fall and Spring and final results are presented at the end of a fiscal year (June).

STATE OF CONGESTION

The triennial arterial monitoring cycles started in FY2000, thus approximate comparisons can be made among the three years surveying approximately the same set of arterials, e.g., routes studied in FY 2001, FY 2004 and FY 2007 can be compared, and so forth.

⁴ Federal Highway Administration, *Travel Time Reliability Measures*, http://ops.fhwa.dot.gov/perf_measurement/reliability_measures/index.htm

⁵ Although the I-95 Corridor Coalition/INRIX also monitors a portion of arterials in the region (194 centerline miles), the data has not yet been validated for 2009.

⁶ A TPB Fiscal Year (FY) starts on July 1 and ends on June 30 of the next year, e.g., FY 2010 is from 7/1/2009 – 6/30/2010.

The studies consider LOS E and F as “congested” conditions and calculate the percentage of miles under congestion for different time periods of a normal workday (Tuesday through Thursday). According to the percentages of congested miles, congestion on studied arterials tended to become worse over years in the PM peak period (4:00-7:00 PM), especially during the PM peak hour (5:00-6:00 PM), while kept unchanged or relieved in the PM off-peak period (1:00-4:00 PM & 7:00-8:00 PM).

TRAFFIC SIGNAL TIMING

Delays occurred at signalized intersections accounted for a significant portion of overall arterial and urban street delays. Improving traffic signal timing has been identified as a CLRP priority area.

The TPB has conducted two surveys of the status of signal optimization in [2005](#) and [2009](#). The 2009 survey found that of the total 5,400 signalized intersections in the region, 80 percent were computer optimized (56%) or checked or adjusted (24%). If a weighted average methodology was used to describe the results, giving half weights to non-computer methods, then 68 percent of signals were “optimized”. This percentage is the same as what was found in 2005 but better than the 2002 result, 45 percent.

Even though the percentage of optimized signals kept unchanged from 2005 to 2009, the region may have better results than that may indicate because: 1) the most critical signals in many cases were being checked and optimized even more frequently than once every three years; 2) all major agencies (with more than 50 signals) reported that they had optimized or checked significant numbers of their signals within the reporting period – no major agency reported not optimizing or checking; and 3) there were anecdotal reports of more resources annually being put into optimization in recent years than in previous years – this will be beneficial if continued.

Congestion on Transit and Other Systems

TRANSIT

The National Capital Region possesses a multimodal and diverse transit system, including Metrorail, commuter rail and a variety of bus operations. Congestion on the transit system is always one of the concerns of the CMP.

Congestion on the region’s highway system often has an impact on transit systems, such as rail and bus. The identified congested locations on highways, especially those on the Washington Metropolitan Area Transit Authority’s (WMATA) [Priority Corridor Network](#), are usually also bottlenecks for bus transit. Relieving highway congestion will directly have a positive impact on bus operations.

Congestion can also be an issue within transit. If the demand for buses, rail and train is high and the capacity cannot keep up with that demand, then transit becomes overcrowded. Congestion exists within certain transit stations, especially multimodal transit centers, e.g. Union Station. The [2008 Metrorail Station Access & Capacity Study](#) found that 19 Metrorail stations need to

expand their capacity in order to satisfy the demand imposed by existing large ridership and/or future ridership increases.

PARK-AND-RIDE FACILITIES

The National Capital Region has over 300 park-and-ride lots where commuters can conveniently join up with carpools, vanpools, or connect to public transit. According to the region's [Commuter Connections](#) program, about one third of Park & Ride Lots have commuter bus service available; approximately one third of the Park & Ride Lots have rail service available, including Metro, MARC, VRE and Baltimore Light Rail; parking is free at 90% of the Park & Ride Lots; and about 25% of the Park & Ride Lots have bicycle parking facilities.

The [2008 Metrorail Station Access & Capacity Study](#) found Metro presently owns and operates 58,186 parking spaces. On an average weekday, almost all of those spaces are occupied, especially stations at East Falls Church, Van Dorn Street, Naylor Road and Branch Ave. Only a handful of stations—White Flint, Wheaton, College Park-U of MD, Prince George's Plaza, and Minnesota Ave—have a substantial amount of daily unused available capacity.

AIRPORT ACCESS

The transportation linkage between airports and local activities is a critical component of the transportation system. The Washington region has two major airports – Ronald Reagan Washington National Airport (DCA) in Arlington, VA, and Washington Dulles International Airport (IAD) in Loudoun County, VA. The region is also served by the nearby Baltimore/Washington International Thurgood Marshall Airport (BWI). According to the most recent TPB [Air Passenger Survey](#), the majority (94%) of those traveling to the region's airports does so via the highway network (i.e. personal cars, rental cars, taxis, buses). Therefore, understanding ground airport access is important to congestion management.

The TPB regularly carries out Regional Airport Ground Access Travel Time Studies ([1995, 2003](#)) and provides relevant information to congestion management. Comparing the 2003 ground access travel time data to that of 1995, it was found travel time overall was increasing slightly, with more increase in the AM peak period than in the PM peak period.

FREIGHT

The National Capital Region has a responsive freight system to support the vitality of economy and quality of life. This region features a consumer and service-based economy and approximately three quarters of freight traveling to, from, or within the region is transported by truck⁷. The interaction between freight movement and passenger travel is high. The following five worst truck bottlenecks⁸ are also among the most congested locations for all traffic.

- I- 95 at VA-7100, Virginia
- I- 95 at VA-234, Virginia

⁷ . *Enhancing Consideration of Freight in Regional Transportation Planning*, Cambridge Systematics, Inc., 2007. <http://www.mwcog.org/uploads/committee-documents/bF5fW1pX20080222142629.pdf>

⁸ I-95 Corridor Coalition, *Mid-Atlantic Truck Operations study – Final Report*. Cambridge Systematics, Inc. October 2009. http://www.i95coalition.net/i95/Portals/0/Public_Files/pm/reports/DFR1_MATOps_Truck%20Operations%20V3.pdf

- I-95 at I- 495, Maryland
- I- 495 at American Legion Bridge, Virginia
- I-495 at I-66, Virginia

National Comparison of the Washington Region's Congestion

The Washington region is among the several most congested metropolitan areas in the nation. Based on the ratio of actual travel time over free flow travel time (or travel time index), the region ranked 4th in Texas Transportation Institute's [2007 Urban Mobility Report](#), and 3rd in [INRIX's 2009 National Traffic Scorecard](#). According to the Urban Mobility Report, annual delay per traveler in the region increased from 16 hours in 1982 to 62 hours in 2007, the fastest increase in the nation. The report also ranks savings generated by travel demand management strategies and operational solutions to congestion problems: the Washington region ranked 5th in terms of savings created by public transportation improvements and 7th in terms of savings created by operational treatment.

Congestion Management Strategies

The CMP has been playing an important role in developing strategies, including strategies in association with capacity-expanding projects, to combat congestion or mitigate the impact of congestion. The CLRP and TPB member agencies have pursued many alternatives to capacity increases, with considerations of these strategies informed by the CMP. Implemented or continuing strategies include demand management strategies and operational management strategies.

DEMAND MANAGEMENT STRATEGIES

Demand Management aims at influencing travelers' behavior for the purpose of redistributing or reducing travel demand. Examples of TPB's demand management strategies include:

- Commuter Connections Program – Including strategies such as Telework, Employer Outreach, Guaranteed Ride Home, Live Near Your Work, Carpooling, Vanpooling, Ridematching Services, Car Free Day, and Bike To Work Day.
- Promotion of local travel demand management – Local demand management strategies are documented in the main body of the CMP Technical Report.
- Public transportation improvements – The Washington region continues to support a robust transit system as a major alternative to driving alone.
- Pedestrian and bicycle transportation enhancements as promoted and tracked through the Bicycle and Pedestrian Planning program – The number of bicycle and pedestrian facilities in the region has increased in recent years; the District of Columbia bikesharing program was one of the first of its kind in North America.
- Land use strategies – Including those promoted by the Transportation-Land Use Connections (TLC) Program.

OPERATIONAL MANAGEMENT STRATEGIES

Operational management focuses on improvements made to the existing transportation system to keep it functioning effectively. Examples of TPB's operational management strategies include:

- High Occupancy Vehicle (HOV) facilities – Existing HOV facilities include I-66, I-95/I-395, I-270, US-50 and the Dulles Toll Road.
- Variably-Priced Lane Facilities – Facilities that are planned or currently under construction include the Maryland Intercounty Connector (ICC) (all lanes will be tolled as a variable-rate express toll facility), the Northern Virginia Capital Beltway High Occupancy Toll (HOT) lanes, and the Northern Virginia I-95/I-395 HOT lanes.
- Incident Management – Notably the Metropolitan Transportation Operations Coordination (MATOC) program, whose development the TPB helped shepherd, uses real-time transportation systems monitoring and information sharing to help mitigate the impacts of non-recurring congestion.
- Intelligent Transportation Systems are considered, particularly through the Management, Operations, and Intelligent Transportation Systems (MOITS) program and committees. Examples include traffic signal optimization, safety service patrols, and traveler information.

CAPACITY INCREASE PROJECTS

Federal law and regulations list capacity increases as another possible component of operational management strategies, for consideration in cases of elimination of bottlenecks, safety improvements and/or traffic operational improvements. These capacity increase projects are documented in CLRP or TIP.

There have been relatively few capacity increase projects in recent years, however. This region has an emphasis on demand and operational management strategies, such as transit improvements, the Commuter Connections program and the Management, Operations and Intelligent Transportation Systems (MOITS) program.

Assessment of Congestion Management Strategies

ASSESSMENT OF IMPLEMENTED STRATEGIES

The TPB assesses the implemented congestion management strategies in a variety of ways. Many strategies have specific assessments and the overall effectiveness of all strategies is repeatedly evaluated by congestion monitoring and analysis.

Specific assessments (of individual or several strategies):

- A variety of surveys within the Commuter Connections Program are regularly conducted to provide firsthand data inputs for the assessments, including the Guaranteed Ride Home Customer Satisfaction Survey, Commuter Connections Applicant Placement Rate Survey, State of the Commute Survey, Employee Commute Surveys, Carshare Survey, Vanpool

Driver Survey, Employer Telework Assistance Follow-up Survey, and the Bike-to-Work Day Participant Survey.

- In conjunction with the regional air quality process, vehicle trips reduced, vehicle miles of travel (VMT) reduced and environmental benefits are assessed in the Transportation Emission Reduction Measure (TERM) Evaluations.
- Public transportation improvements, pedestrian and bicycle transportation improvements, and land use strategies are assessed in Regional Household Travel Surveys, Regional Bus Surveys, Regional Activity Centers and Regional Activity Clusters Studies, the Regional Travel Trends Report, and Cordon Counts.
- The region's HOV facilities are monitored by the TPB's HOV monitoring and surveys.
- Status of traffic signal timing is assessed by Management, Operations and Intelligent Transportation Systems (MOITS) program's traffic signal timing surveys.
- The Metropolitan Area Transportation Operations Coordination (MATOC) program is assessed by a benefit-cost study.

Overall assessments (of all implemented strategies):

- The TPB's aerial photography survey of the region's freeway system congestion conditions (every three years for AM and PM peak periods and every five years for weekend and off-peak period).
- The TPB's arterial floating car travel time and speed studies (every year a sample of major arterials in DC, MD and VA is studied and the same sample is repeated every three years).
- In addition to the TPB's monitoring activities, the TPB also utilize other regional and national monitoring activities to complement and enhance the congestion monitoring and analysis in the National Capital Region. These utilized "outside" monitoring activities include:
 - a) I-95 Corridor Coalition/INRIX, Inc. probe-vehicle-based traffic monitoring data
 - b) The FHWA Transportation Technology Innovation and Demonstration (TTID) Program/ Traffic.com traffic monitoring
 - c) Texas Transportation Institute's Urban Mobility Report.

ASSESSMENT OF POTENTIAL STRATEGIES

The TPB also proposes and evaluates creative new options to improve future congestion and performance of the region's transportation system in the Scenario Study. The TPB launched the Regional Mobility and Accessibility Study (RMAS) in 2001 and completed phase I of the study in 2006. Five strategies and scenarios were analyzed:

- *"Higher Households in Region" Scenario:* To reduce the estimate of forecast growth in the long distance commuting trips to the to the Washington region. This scenario assumed the development of more housing in the region than is currently planned for by 2030.
- *"More Households in Inner Areas" Scenario:* To enable more workers to live closer to their jobs by assuming some shifts in future household growth from the outer suburbs of the region to the inner suburbs and core area jurisdictions.

- *“More Jobs in Outer Areas” Scenario*: To examine the impacts of shifting some of the forecast job growth from core area jurisdictions to the outer suburbs.
- *“Region Undivided Scenario”*: To look at the potential impacts of shifting some of the future household and job growth from the western portion of the region to the eastern portion.
- *“Transit Oriented Development (TOD)” Scenario*: To examine the impacts of concentrating more of the region’s future growth in areas that could be efficiently served by transit.

The Scenario Study entered into phase II in 2007 as the TPB Scenario Task Force was formed. Since then two new scenarios have been developed and are currently under study:

- *“CLRP Aspirations” Scenario*: It is an integrated land use and transportation scenario for 2030 building on the key results of the five TPB scenarios analyzed earlier. It includes a regional high-quality bus rapid transit (BRT) network operating on an extensive network of variably priced lanes.
- *“What Would It Take?” Scenario*: It starts with specific goals for reducing greenhouse gas transportation emissions for 2030 and beyond. It assesses how such goals might be achieved through different combinations of interventions that include increasing fuel efficiency, reducing the carbon-intensity of fuel, and improving travel efficiency.

Some potential operational congestion management strategies are assessed in the newly developed [Strategic Plan for the Management, Operations and Intelligent Transportation Systems \(MOITS\) Planning Program](#).

TPB also assesses special potential strategies on an as-needed basis, such as congestion pricing.

Compiling Project-Specific Congestion Management Information

Pursuant to Federal regulations, the TPB encourages consideration and inclusion of congestion management strategies in all Single Occupancy Vehicle (SOV) capacity-increasing projects. This involves compiling and analyzing information in the Call for Projects documentation forms, which are submitted from regional agencies when the CLRP is developed.

The Call for Projects documentation requests any project-specific information available on congestion that necessitates or impacts the proposed project. Agencies compile this information from various sources, including TPB-published congestion information (if available), internal or other directly measured information, or by conducting engineering estimates of the Level of Service (LOS). TPB compiles and analyzes this submitted information, along with information from other CMP sources.

Specifically for SOV capacity-increasing projects, the TPB requests documentation that the implementing agency considered all appropriate systems and demand management alternatives to the SOV capacity. In the Call for Projects documentation a special set of SOV questions is completed by implementing agencies and the TPB compiles this information.

Congestion Management as a Process in the CLRP

The four major components of the CMP as described earlier are fully integrated in the CLRP. More specifically:

In monitoring and evaluating transportation system performance, the TPB uses Skycomp aerial photography freeway monitoring and a number of other travel monitoring activities to support both the CMP and travel demand forecast model calibration, complementing operating agencies' own information, and illustrating locations of existing congestion. CLRP travel demand modeling forecasts, in turn, provide information on future congestion locations. This provides an overall picture of current and future congestion in the region, and helps set the stage for agencies to consider and implement CMP strategies, including those integrated into capacity-increasing roadway projects.

The CMP component of the CLRP defines and analyzes a wide range of potential demand management and operations management strategies for consideration. TPB, through its Technical Committee, Travel Management Subcommittee, Travel Forecasting Subcommittee, and other committees, reviews and considers both the locations of congestion and the potential strategies when developing the CLRP.

For planned (CLRP) or programmed (TIP) projects, cross-referencing the locations of planned or programmed improvements with the locations of congestion helps guide decision makers to prioritize areas for current and future projects and associated CMP strategies. Maps in the 2009 CLRP showed a high correlation between the locations of planned or programmed projects and locations where congestion is being experienced or is expected to occur.

Thus CLRP and TIP project selection is informed by the CMP, and implementation of CMP strategies is encouraged. The region relies particularly on non-capital congestion strategies in the Commuter Connections program of demand management activities, and the Management, Operations, and Intelligent Transportation Systems (MOITS) program of operations management strategies. Assessments of these programs are analyzed, along with regular updates of travel monitoring to look at trends and impacts, to feed back to future CLRP cycles.

The TPB also compiles information pertinent to specific projects in its CMP documentation process (form) within the annual CLRP Call for Projects. This further assures and documents that the planning of federally-funded SOV projects has included considerations of CMP strategy alternatives and integrated components.

Key Findings of the 2010 CMP Technical Report

1. 2008 (when fuel prices were at an all-time high) saw reductions in congestion compared to previous years, but congestion returned to higher levels by 2009.
 - a. Total freeway lane miles with level of service (LOS) F congestion in the AM and PM peak periods dropped by 24 percent from 2005 to 2008, almost back to 2002 levels.
 - b. Peak period mile-hours of congestion on the sample of the region's freeway system increased 14 percent in the second half of 2009 compared to the second

half of 2008; all time mile-hours of congestion increased 24 percent in the same time frame.

2. Congestion varies seasonally on freeways in the region: January had the least congestion and June had the worst congestion in 2009.
3. Travel time reliability has been examined in the CMP for the first time. In line with the increase of congestion, freeway travel time reliability deteriorated 13 percent from 2008 to 2009.
4. Arterial congestion tended to become worse over the years in the PM peak period (4:00-7:00 PM), especially during the PM peak hour (5:00-6:00 PM), while kept unchanged or relieved in the PM off-peak period (1:00-4:00 PM & 7:00-8:00 PM).
5. There was a region wide modal share shift from auto driver/passenger to walk, transit, bike and other modes from 1994 to 2007/2008.
6. The transit system in the Washington region serves as a major alternative to driving alone – transit mode share is among the highest several metropolitan areas in the country.
7. The Commuter Connections program remains a vital means to assist and encourage people in the Washington region to use alternatives to the single-occupant automobile.
8. Congestion management strategies of Management, Operations, and Intelligent Transportation Systems (MOITS) provide essential ways to make most of the existing transportation facilities.
9. Introduction of variably priced lanes (VPLs) remains an effective way to provide alternatives to travelers and manage congestion.
10. The Metropolitan Area Transportation Operations Coordination (MATOC) program enhances regional coordination for regional-significant incidents and the program is cost-effective with a conservative benefit to cost ratio of 10:1.

Recommendations for the Congestion Management Process

The 2010 CMP Technical Report documents the updates of the Congestion Management Process in the Washington region from mid 2008 to early 2010. Looking forward, the report leads to several important recommendations for future improvements.

1. **Continue the Commuter Connections Program.** The Commuter Connections program is a primary key strategy for demand management in the National Capital Region and it is beneficial to have a regional approach. Meanwhile, this program reduces transportation emissions and improves air quality, as identified by the TERMS evaluations.
2. **Continue the MATOC program and agency/jurisdictional transportation management activities.** The program/activities are key strategies of operational management in the National Capital Region. It addresses non-recurring congestion, improves air quality, and is cost-effective (the ratio of benefit to cost is conservatively 10:1).
3. **Capacity increasing projects should consider variable pricing and other management strategies.** Variably priced lanes (VPLs) provide a new option to avoid congestion for travelers and an effective way to manage congestion for agencies.

4. **Encourage implementation of congestion management for major construction projects.** The CMP should examine these projects and evaluate their impacts on regional congestion. Particularly, the Northern Virginia HOT lanes and the TIGER grant supported transit improvements represent examples of operational and demand management strategies respectively that can provide important contributions to the CMP.
5. **Continue and enhance the use of continuous, probe-based congestion monitoring data.** As a complementary data source to the Skycomp aerial survey, the I-95 Corridor Coalition – INRIX – University of Maryland partnership provides the CMP an innovative and profound data source for both congestion and reliability analyses. It is expected that additional coverage in Maryland, including I-270 and freeways in Frederick County, would become available in the near future. It is also possible to have continuous, probe-based data from other valid providers. Up-to-date congestion information should be provided as needed to inform decision making.
6. **Integrate probe-based congestion monitoring data and location-fixed sensor data.** The Washington region is currently covered by both the I-95 Corridor Coalition’s Vehicle Probe Project and the Federal Highway Administration’s [Transportation Technology Innovation and Demonstration \(TTID\) Program](#), the latter uses location-fixed sensors for continuous highway performance monitoring. Probe-based data are superior to location-fixed sensor data in travel time and speed information but lack of traffic volume – one of the parameters location-fixed sensors do provide. A combination of the two is expected to provide more meaningful insights to the nature and causes of congestion and unreliability.
7. **Continue travel time reliability analysis.** Travel time reliability is an important issue closely related to congestion, especially non-recurring congestion. Future CMP technical reports will expand the current segment-based reliability analysis to corridor-based analysis. Travel time reliability will also be used as one of the performance measures to assess congestion management strategies.
8. **Explore the use of INRIX and other emerging data sources to produce online quarterly snapshots of regional congestion.** More frequent updates of congestion would better inform policy makings and enhance the Congestion Management Process.

This page intentionally left blank.

MAIN REPORT

1. INTRODUCTION

1.1 Need for a CMP Technical Report

This report presents a technical review of the Congestion Management Process (CMP), as addressed by the Transportation Planning Board (TPB) of the Metropolitan Washington Council of Governments (COG).

The Safe, Accountable, Flexible, Efficient, Transportation Equity Act: A Legacy for Users (SAFETEA-LU) requires that metropolitan transportation planning processes include a Congestion Management Process (CMP). The CMP is similar to the previous requirements for a Congestion Management System (CMS), except that the change in name and acronym of CMS to CMP is intended to place a greater emphasis on the planning process and environmental review process, while maintaining and developing effective management and operation strategies. Federal regulations state that Metropolitan transportation planning areas with a population of 200,000 or more, designated as a Transportation Management Area (TMA), are required to have a CMP, and that long-range transportation plans developed after July 1, 2007 must contain a CMP component. Also, in metropolitan planning areas classified as non-attainment for ozone and Carbon Monoxide (CO) under the Clean Air Act, no single occupant vehicle (SOV) capacity expanding project can receive federal funds unless it shows that the CMP has been considered.

Federal regulations state that:

*“The transportation planning process shall address congestion management...
...through a process that provides for safe and effective integrated management and operation of the multimodal transportation system...
...based on a cooperatively developed and implemented metropolitan-wide strategy...
...of new and existing transportation facilities...
...through the use of travel demand reduction and operational management strategies.”⁹*

Additionally, the federal certification of the TPB planning process, dated March 2006, addressed CMS/CMP with the following recommendation:

The TPB should develop a comprehensive description of a regional Congestion Management System to demonstrate its application at critical stages of the metropolitan planning process, including the development of the CLRP, TIP, and the development of major projects and policies. The description should be part of the next update to the CLRP or a stand-alone document that is completed in one year from the issuance of this

⁹ “Statewide Transportation Planning; Metropolitan Transportation Planning; Final Rule,” *Federal Register*, Vol. 72, No. 30, February 14, 2007, § 450.320 (a) page 7274 – emphasis added.

report. The description can build on key elements in place, including monitoring and evaluating alternatives to new capacity (such as for the Mixing Bowl Springfield Exchange and the Woodrow Wilson Bridge) and the range of congestion related strategies (such as the Commuter Connections Program).¹⁰

The Congestion Management Process is intended to operate within or in conjunction with the planning process, which is the focal point for consideration of other factors, such as Clean Air Act requirements, transit, funding, land use scenarios, and non-motorized alternatives. The planning process also leads to decisions on which projects are programmed and implemented. The CMP will provide better information to decision-makers, such as the TPB, who consider transportation planning in our region.

This report is a step in the CMP, which is an ongoing activity. Just as there are many causes of congestion, there are also many solutions. While this report documents the region's recent CMP activities, the concept of addressing congestion and meeting regional goals will continue to be an integral part of the metropolitan planning process.

1.2 The Institutional Context of the CMP in the Washington Region

The federally designated Metropolitan Planning Organization (MPO) for the region is the National Capital Region Transportation Planning Board (TPB) at the Metropolitan Washington Council of Governments (MWCOC). The TPB is charged with producing long-range transportation plans and transportation improvement programs (TIPs) for the region, which includes the District of Columbia as well as portions of the States of Maryland and Virginia. The members of the TPB include representatives from state, county, local government agencies, as well as the Washington Metropolitan Area Transit Authority (WMATA), non-voting members of the Metropolitan Washington Airports Authority, and federal agencies.

The TPB is advised by a standing Technical Committee for transportation. The TPB Technical Committee oversees details of transportation planning and engineering studies and efforts required to support the region's transportation decision-making process. The Technical Committee has a number of standing subcommittees that focus on particular aspects of the transportation planning process, such as aviation, bicycle and pedestrian planning, regional bus planning, travel forecasting, transportation safety, transportation scenarios, and travel management.

The TPB Technical Committee is the oversight committee for the CMP, as the committee that guides long-range plan activity and oversees interaction of the various subcommittees. The Technical Committee is also advised by a number of the standing subcommittees who have knowledge about particular aspects of the CMP (for example, MOITS, Commuter Connections, and Travel Management).

¹⁰ *Transportation Planning Certification Summary Report* (March 16, 2006). Prepared by Federal Highway Administration and Federal Transit Administration. Page 10.

Previous CMS/CMP activities of the region were steered by a CMS Task Force, developed in the mid-1990s. Congestion Management System reports were developed in FY 1995 and FY 1996. However, a decision was then made to fully incorporate congestion management information into the CLRP rather than having a stand-alone document, in order to achieve continuity between the CMS and the CLRP. As such, over the past several years the CMS/CMP process has included data collection and analysis through compilation of information from implementing agencies associated with projects submitted to the CLRP and TIP, and through consideration of management and operations strategies under the Management, Operations, and Intelligent Transportation Systems (MOITS) Policy Task Force and MOITS Technical Subcommittee. The previously published 2008 CMP Technical Report represented a return to the practice of developing a separate Congestion Management document, and the current 2010 report is an updated version of the 2008 report. **Section 1.5** reviews the highlights of this update.

1.3 Coverage Area of the CMP

The Washington region CMP covers the TPB planning area (**Figure 5**).

Figure 5: TPB Member Agencies

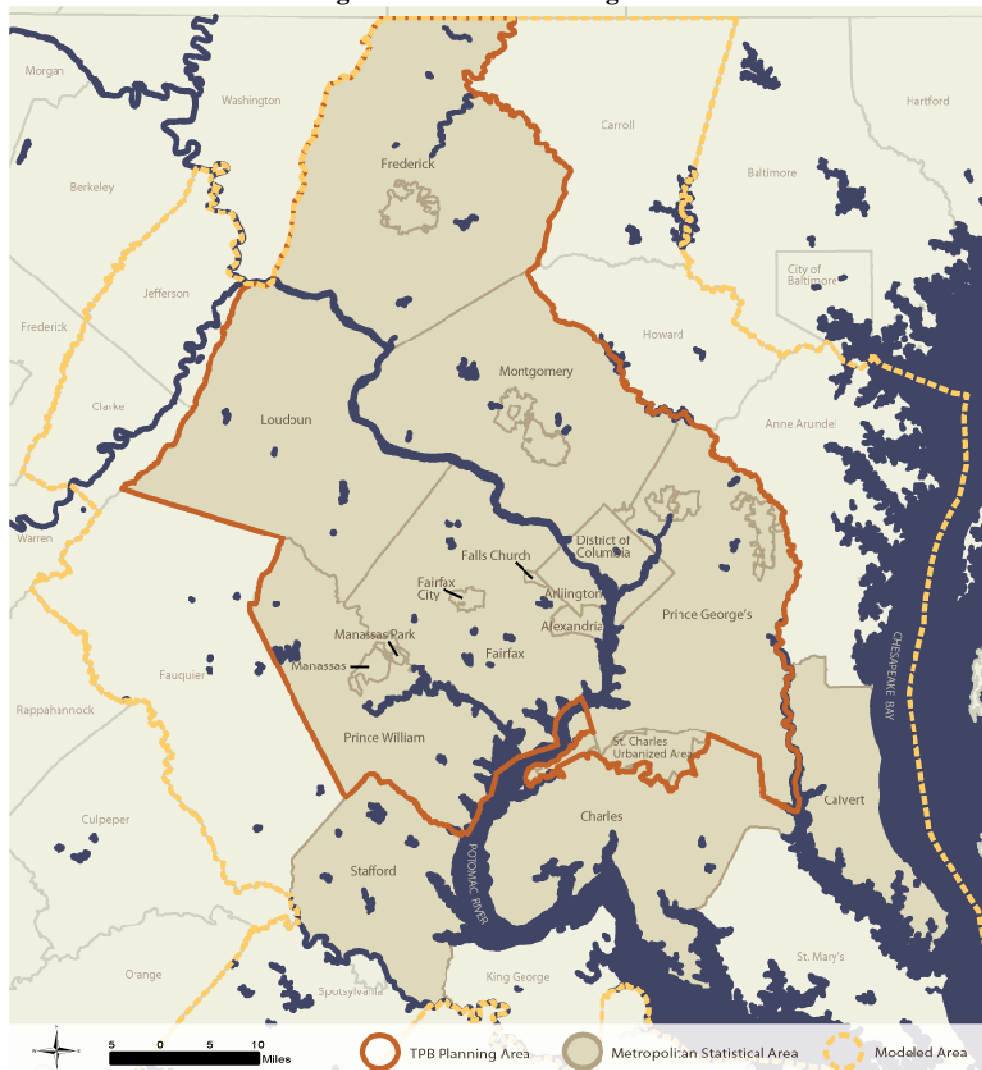

The TPB's planning area covers the District of Columbia and surrounding jurisdictions. In Maryland these jurisdictions include Frederick County, Montgomery County, and Prince George's County and the St. Charles urbanized area of Charles County, plus the cities of Bowie, College Park, Frederick, Gaithersburg, Greenbelt, Rockville, and Takoma Park. In Virginia, the planning area includes Arlington County, Fairfax County, Loudoun County, and Prince William County, and the Cities of Alexandria, Fairfax, Falls Church, Manassas, and Manassas Park.

1.4 Components of the CMP

The Congestion Management Process in the National Capital Region consists of the following four components, all of which are wholly integrated into the CLRP:

1. **Monitoring and Evaluating Transportation System Performance.** This TPB effort includes Skycomp freeway aerial photography survey, arterial monitoring program, regional transportation data clearinghouse, special studies, data collections, as well as congestion analyses leveraged by emerging data sources (e.g. I-95 Corridor Coalition/INRIX data).
2. **Defining and Analyzing Strategies.** This component involves identifying existing and potential strategies by the TPB Technical Committee, subcommittees, and staff. The TPB considers a number of demand management and operational management strategies.
3. **Implementing Strategies.** This TPB effort is to focus on compiling information on strategies that have been implemented, particularly on a region-level basis. Also, the TPB is exploring how to assess previously implemented strategies. Feedback from the process is beneficial when it comes to updating the CMP and considering additional strategies and technical methods.
4. **Compiling Project-Specific Congestion Management Information.** Pursuant to Federal regulations, the TPB encourages consideration and inclusion of congestion management strategies in all SOV capacity-increasing projects. This involves compiling and analyzing information in the Call for Projects documentation forms, which are submitted from regional agencies when the CLRP is developed.

1.5 Highlights of the 2010 Update of the CMP Technical Report

The 2010 CMP Technical Report presented more congestion facts and analyses than the previous report while still maintaining a comprehensive and updated documentation of the congestion management strategies that are considered and implemented in the National Capital Region. The highlights of the 2010 update include:

- **New data source for highway performance monitoring.** As an affiliate member of the I-95 Corridor Coalition, TPB has been recently granted access to the data produced by the Coalition's Vehicle Probe Project. Contacted with INRIX, Inc., an independent traffic information provider based primarily on GPS-equipped commercial fleets, the project

provides live traffic information as well as 5-minute aggregated archived data for the freeways and major alternate arterials along the mid-Atlantic I-95 Corridor. Within the TPB member jurisdictions, there are about 165 centerline miles of freeways and 140 centerline miles of arterials covered by this Vehicle Probe Project. The archived vehicle speed and travel time data obtained from continuous monitoring provide transportation planning agencies a whole new opportunity to improve highway performance monitoring and evaluation. The 2010 CMP Technical Report serves as the pilot of utilizing this emerging data source for highway performance monitoring and congestion analysis in this region (see [Section 2.1.3](#)).

- **Quantified congestion analysis: Travel Time Index and Mile-Hour of Congestion.** Leveraged by the I-95 Corridor Coalition / INRIX data, time-specific congestion information can be calculated. The 2010 CMP Technical Report uses Travel Time Index (the ratio of peak period travel time to free flow travel time) and Mile-Hour of Congestion to quantify congestion intensity, for each road segment as well as all the covered highways in the region as a whole (see [Sections 2.1.3.2 and 2.1.3.3](#)).
- **Travel time reliability analysis: Planning Time Index and Buffer Time Index.** Congestion, especially non-recurring congestion, is closely related to another important highway performance measure, travel time reliability. Studies have shown that travelers value travel time reliability almost equally with travel time itself. The 2010 CMP Technical Report chooses Planning Time Index (the ratio of 95th percentile travel time to free flow travel time) and Buffer Time Index (the difference between 95th percentile travel time and average travel time, normalized by normal travel time) to quantify travel time reliability, for each road segment as well as all the covered highways in the region as a whole (see [Sections 2.1.3.4, and 2.1.3.5](#)).
- **MATOC program.** The Metropolitan Area Transportation Operations Coordination (MATOC) program was officially established on July 1, 2009. The program is currently based out of the Capital Wireless Information Net (CapWIN) offices in Greenbelt, Maryland and there are two operators covering 5 days a week and 13 hours a day (6:00 AM – 7:00 PM). Operators send out an average of 20 regional incidents per month and facilitate the incident responses of different agencies/teams.
- **MOITS Strategic Plan.** The Strategic Plan for the Management, Operations, and Intelligent Transportation Systems (MOITS) planning program is being developed; a draft plan has been released to comments. This Strategic Plan defines and promotes potential regional projects or activities for the management, operations, and application of advanced technology for the region's transportation systems, as well as to advise member agencies on management, operations, and transportation technology deployments for meeting common regional goals and objectives.
- **Periodic updates.** Since the release of the 2008 CMP Technical Report, a variety of planning and program periodic updates and outside data sources have been released. This current report uses these updates to provide the most up-to-date information for the CMP. Some critical updates include, but are not limited to:

- 2009 CLRP and FY 2010-2015 TIP
- Freeway spring 2008 aerial survey results
- Arterial FY 2008 and 2009 floating car surveys results
- Round 7.2 Cooperative Forecasts of the region's demographics
- 2007/08 Household Travel Survey
- 2008 Regional Bus Survey
- WMATA 2008 Metrorail Station Access & Capacity Study
- Texas Transportation Institute 2009 Urban Mobility Report
- INRIX 2009 National Traffic Scorecard
- 2007 Washington-Baltimore Regional Air Passenger Survey
- Transportation Emission Reduction Measure (TERM) Analysis Report FY 2006-2008
- TPB Freight Subcommittee Integrated Freight Report

2. STATE OF CONGESTION

2.1 Congestion of the Metropolitan Area's Major Highways

Identifying congested locations on our major highways is important in providing a regional overview of where and why congestion is occurring. The regional planning process traditionally has two approaches for congestion monitoring on major highways: an aerial survey approach for freeways and a travel time/speed monitoring system for arterial highways. Recently, a third-party data source has been made available through the I-95 Corridor Coalition that contains 5-minute aggregated speed and travel time data for a portion of freeways and major arterials in the region. This report will utilize this new data source to provide more congestion information.

2.1.1 TPB FREEWAY CONGESTION MONITORING

Freeways comprise the critical backbone of the region's roadway system, and provide the most important indicator of our overall system. Generally they are used for longer distance travel and/or people opting for the most direct route between two points. They are different from arterials in that they have fewer access points, no at-grade intersections, more lanes, and generally can accommodate higher speeds. Because of their nature and their limited number, regional freeway congestion can be analyzed comprehensively for all freeway miles (in contrast to the numerous arterial highway segments which are monitored on a structured sample basis).

The TPB's regional freeway monitoring program is based upon comprehensive aerial photography of the region's freeways. The TPB has contracted with Skycomp, Inc. to conduct a systematic aerial study of regional freeway congestion since 1993. Peak period congestion is monitored on a once-every-three-years cycle during the AM and PM peak periods, off-peak and weekend congestion is monitored once every five years, and there are periodic incident-related monitoring efforts. It provides a wealth of information on the region's freeways, including the overall conditions of the freeways, specific congested locations, trends over time, and identification of factors associated with the congested conditions.

During a survey period, fixed-wing aircrafts follow designated flight patterns along the region's approximately 300 centerline miles of limited-access highways. Survey flights were conducted on weekdays, excluding Monday mornings, Friday evenings, and mornings after holidays, during the following time periods:

- *Morning surveying times:*
 - 6:00 AM – 9:00 AM outside the Capital Beltway;
 - 6:30 AM – 9:30 AM inside the Capital Beltway.
- *Evening surveying times:*
 - 4:00 – 7:00 PM inside the Capital Beltway
 - 4:30 – 7:30 PM outside the Capital Beltway

During the survey flights, overlapping photographic coverage was obtained of each designated highway, repeated once an hour over four morning and four evening commuter periods (this means that, altogether, there were 12 morning and 12 evening observations of each highway segment).

Data was then extracted from the aerial photographs to measure average traffic flow density by link and by time period. The density was further converted to level of service (LOS) using methods presented in the *Highway Capacity Manual 2000*. LOS “A” reflects generally free-flow conditions, and levels “E” and “F” reflects the most severe congestion with extended delays, as illustrated in the following diagram (Figure 6).

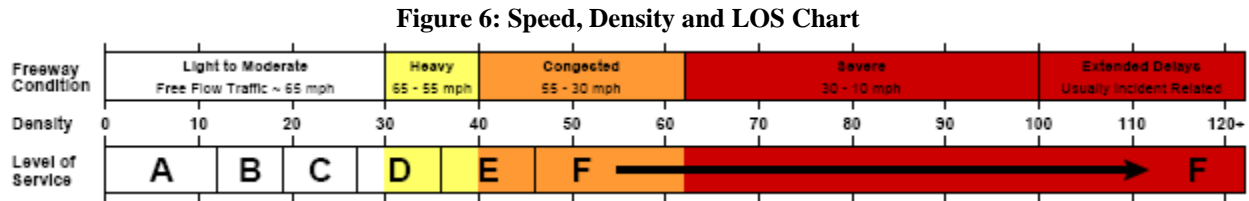

The most recent peak period survey was conducted in Spring 2008 and the final report, *Traffic Quality on the Metropolitan Washington Area Freeway System: 2008 Report*, can be downloaded from www.mwcog.org¹¹.

2.1.1.1 The Overall Congestion Picture

Figure 7 and Figure 8 below illustrate the freeway locations throughout the region with the most severe congestion in the morning and evening, respectively¹². From these figures a few different things are evident in terms of morning and evening congestion during rush hours.

The Washington region is like many other urban areas in that the region continues to grow and more people are choosing to commute longer distances to their jobs in and around the Beltway, closer to the inner core. This is one cause of congestion on some segments of I-66, I-95, and VA 267 in Virginia, I-395 and I-295 in the District of Columbia, and I-270, I-95, and MD 295 in Maryland. The same segments experience congestion in the opposite direction during the evening. “Reverse” congestion (i.e. congestion occurring from traffic moving away from the city center during peak period travel) is also occurring.

In addition to the “in-out” movement there is also an “east-west” pattern of mobility. The Washington region is divided in terms of jobs and housing, with generally more job growth on the west. As a result, many people are commuting from the eastern Maryland suburbs, to the western Maryland suburbs or across District of Columbia to the Virginia suburbs for work. Using Figure 1 as an example, I-495 both north and south of the District of Columbia experiences west-bound congestion, in addition to I-95, MD/DC 295, and I-270 leading to the Capital Beltway. Figure 2 shows evening congestion occurring in the exact opposite direction, particularly on the I-495 Inner Loop; the cause of which could be attributed to commuters returning home.

¹¹ *Traffic Quality on the Metropolitan Washington Area Freeway System: 2008 Report*. Prepared by: Skycomp, Inc. (Columbia, Maryland). <http://www.mwcog.org/uploads/pub-documents/81ZdXg20090526131814.pdf>

¹² The morning times of coverage were 6:00 – 9:00 AM outside the Capital Beltway and 6:30 – 9:30 AM inside the Capital Beltway. The evening times were 4:00 – 7:00 PM inside the Capital Beltway and 4:30 – 7:30 PM outside the Capital Beltway.

Figure 7: Morning Peak Period Regional Congestion - Spring 2008

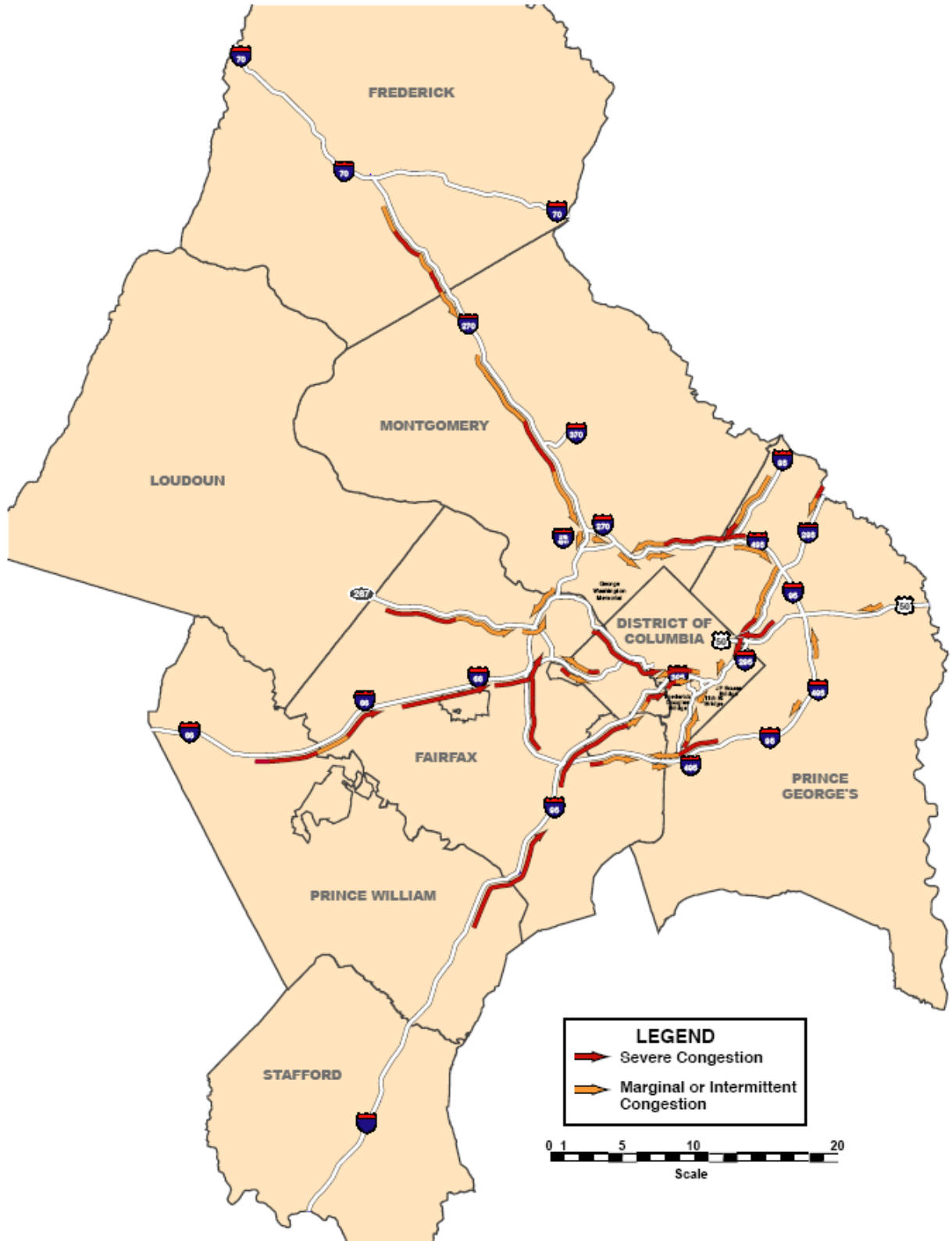
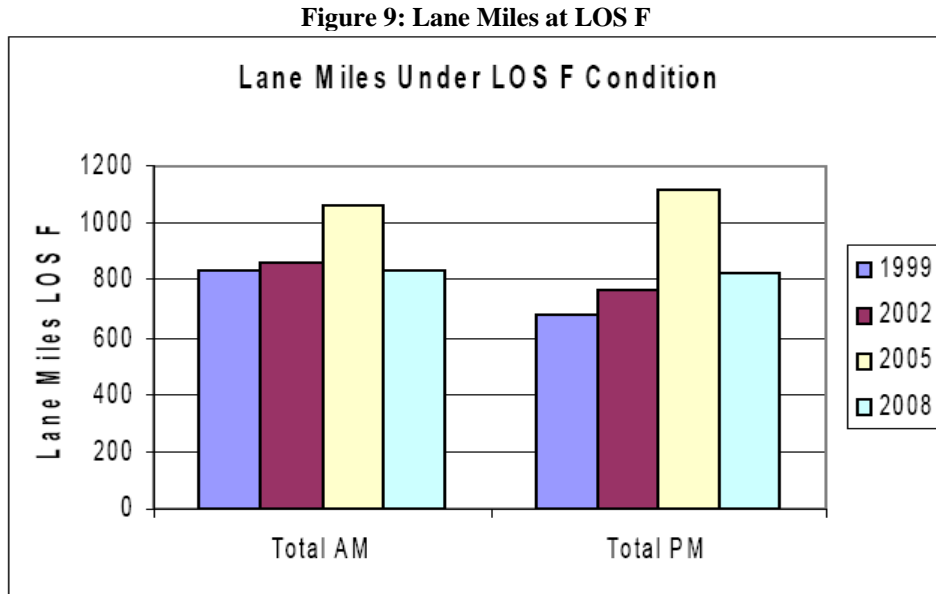

Figure 9 compares the lane miles found to be operating at LOS “F” in the last 4 surveys and a significant decrease from 2005 to 2008 was found. The number of congested lane miles in Spring 2008 reduced back to 2002 levels. This decrease could be largely explained by the economic downturn and the historically high fuel prices in 2008.



2.1.1.2 Top Ten Congested Locations from the Aerial Survey

Figure 10 maps and lists the most congested locations on the region’s freeway system. These locations were obtained by ranking the densities of all segments and picking the top ten irrespective of whether they are congested during the AM or PM peak period.

Compared to the top ten congested locations found in the 2005 survey, eight of the ten most congested locations in 2008 were new (the two exceptions were WB 11th Street Bridge and EB I-66 from VA 267 to Westmoreland St). In 2008, six of the ten most congested locations were on or adjacent to the Capital Beltway and four of them were in the center core of the freeway system: DC portion of I-395 and 11th Street Bridge. While in 2005, four were on or adjacent to the Beltway, one was outside of the Beltway, three were in the center core and two approaching the center core. More comparison of the 2005 and 2008 surveys could be found in a later section “Significant Changes from 2005 to 2008”.

The I-95 Corridor Coalition/INRIX data also identified the top 25 most congested bottlenecks for the INRIX data covered freeways in the region (Section 2.1.3). Seven of the 25 top bottlenecks are already listed by the Skycomp survey, and the rest of 18 bottlenecks are provided in Table 3 and merit further investigation for improvements.

Figure 10: Top Ten Congested Locations – Spring 2008



Top Ten Congested Segments on the Freeway System (2008)

Rank	Route	From	To	Density	Speed Range
1	SB Southwest/Southeast Fwy (5:30 to 6:30 PM)	Southwest Fwy/I-395 merge	US Route 1	115	10 to 15 MPH
2	WB 11th St Bridge (8 to 9 AM)	I-295/DC 295	Southeast Fwy	110	10 to 15 MPH
3	NB Southeast Fwy (4:30 to 6:30 PM)	11th Street	Pennsylvania Ave	105	12 to 20 MPH
4	OL I-495 (8 to 9 AM)	MD 650 (New Hampshire Ave)	US 29 (Colesville Rd)	100-105	12 to 20 MPH
5A	IL I-495 (5:30 to 6:30 PM)	VA 193 (Georgetown Pike)	George Washington Pkwy	100	14 to 20 MPH
5B	NB Southwest Fwy (4:30 to 5:30 PM)	US Route 1	Lenfant Plaza	100	14 to 20 MPH
5C	EB I-66 HOV (8 to 9 AM)	VA 243 (Nutley St)	I-495	100	14 to 20 MPH
5D	EB I-66 (6:30 to 7:30 PM)	VA 267	VA 693 (Westmoreland St)	100	14 to 20 MPH
5E	IL I-495 (5:30 to 6:30 PM)	MD 187 (Old Georgetown Rd)	MD 355 / I-270	100	14 to 20 MPH
5F	NB I-95 VA (7 to 8 AM)	VA 644 (Franconia Rd)	I-495	100	14 to 20 MPH

Table 3: Additional (to the Skycomp Survey) Most Congested Locations Identified by INRIX 2009 Data

Rank	Road/ Direction	Segment/Interchange	Length (miles)	Hours of Congestion in A Week	Average Speed when Congested (mph)
1	I-95 HOV SB	VA-234/EXIT 152 -- I-95 MERGE	0.68	31	18
3	I-95 SB	VA-234/DUMFRIES RD/EXIT 152	0.63	32	20
4	I-95 NB	VA 3000/EXIT 158 -- VA-642/EXIT 163	5.49	35	22
5	I-66 WB	VA-234/PR WM PKWY/EXIT 44	0.41	27	17
6	MD-295 NB	I-495 -- POWDER MILL RD	4.18	30	21
7	I-95/I-395 SB	I-495 -- VA-7100/EXIT 166	5.29	28	20
8	I-95 SB	US-1/EXIT 161 -- VA-123/EXIT 160	1.60	32	23
11	I-95 SB	VA-619/JOPLIN RD/EXIT 150	1.90	27	21
12	I-66 EB	VA-243/EXIT 62 -- I-495/EXIT 64	3.11	22	17
14	I-395 HOV NB	EADS ST -- MEMORIAL BRIDGE	1.58	27	20
15	I-495 IL	US-50/ARLINGTON BLVD/EXIT 50	0.67	26	22
16	I-495 IL	VA-267/EXIT 45	0.51	20	17
18	I-66 WB	VADEN DR/EXIT 62	0.67	24	22
19	VA-267 EB	I-66	1.94	20	18
20	I-95 SB	DALE BLVD/EB EXIT 156	1.99	18	18
22	I-495 OL	VA-123/EXIT 11	0.70	20	19
24	I-495 IL	CABIN JOHN PKWY -- MD-190	0.46	16	16
25	I-95 HOV NB	VA-7900/EXIT 169	0.44	20	23

2.1.1.3 Longest Delay Corridors from the Aerial Survey

Corridors with the longest delay was a new metric introduced in the 2008 survey report. The purpose of this metric was to identify corridors which might not have bottlenecks in the “Top Ten Congested Locations” but were long congested corridors. Delay was calculated by estimating the additional travel time during congested conditions over the free flow travel time. Free flow speed was assumed to be 60 mph. **Figures 11 and 12** present the top five congested corridors in the AM and PM peak period.

Figure 11: Longest Delay Corridors - Morning Peak Period (Spring 2008)

Site Name	Road Name	Time	Direction	From	To	Queue Length (miles)	Estimated Travel Time (minutes)	Estimated Speed (mph)	Estimated Delay (minutes)
Site #1	I-66	8:00 – 9:00	Eastbound	VA 234 Bypass	I-495	19.5	41	30	21
Site #2	I-495	8:00 – 9:00	Outerloop	MD 201	I-270	12	31	25	19
Site #3	I-95	7:00 – 8:00	Northbound	Dale Blvd	Lorton Rd	7	19.5	20	12.5
Site #4	I-270	8:00 – 9:00	Southbound	Clarksburg Rd	I-270 Spur	16	28.5	35	12.5
Site #5	I-395	7:30 – 8:30	Northbound	Franconia Rd	VA 7	7	18	25	11

* Free flow travel times based on speed of 60 mph

Note: Congestion on I-495 in the vicinity of the Woodrow Wilson Bridge was excluded due to ongoing construction

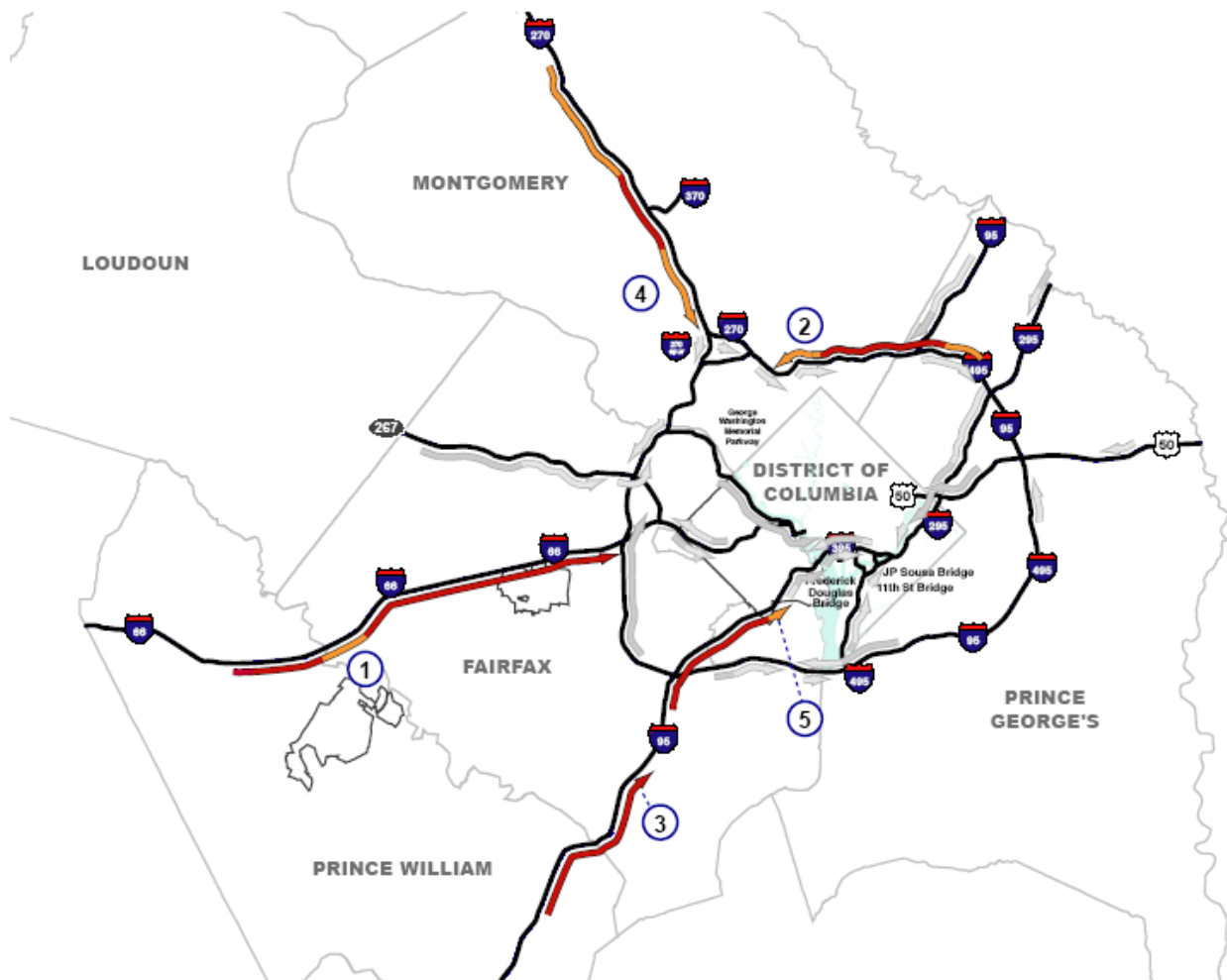
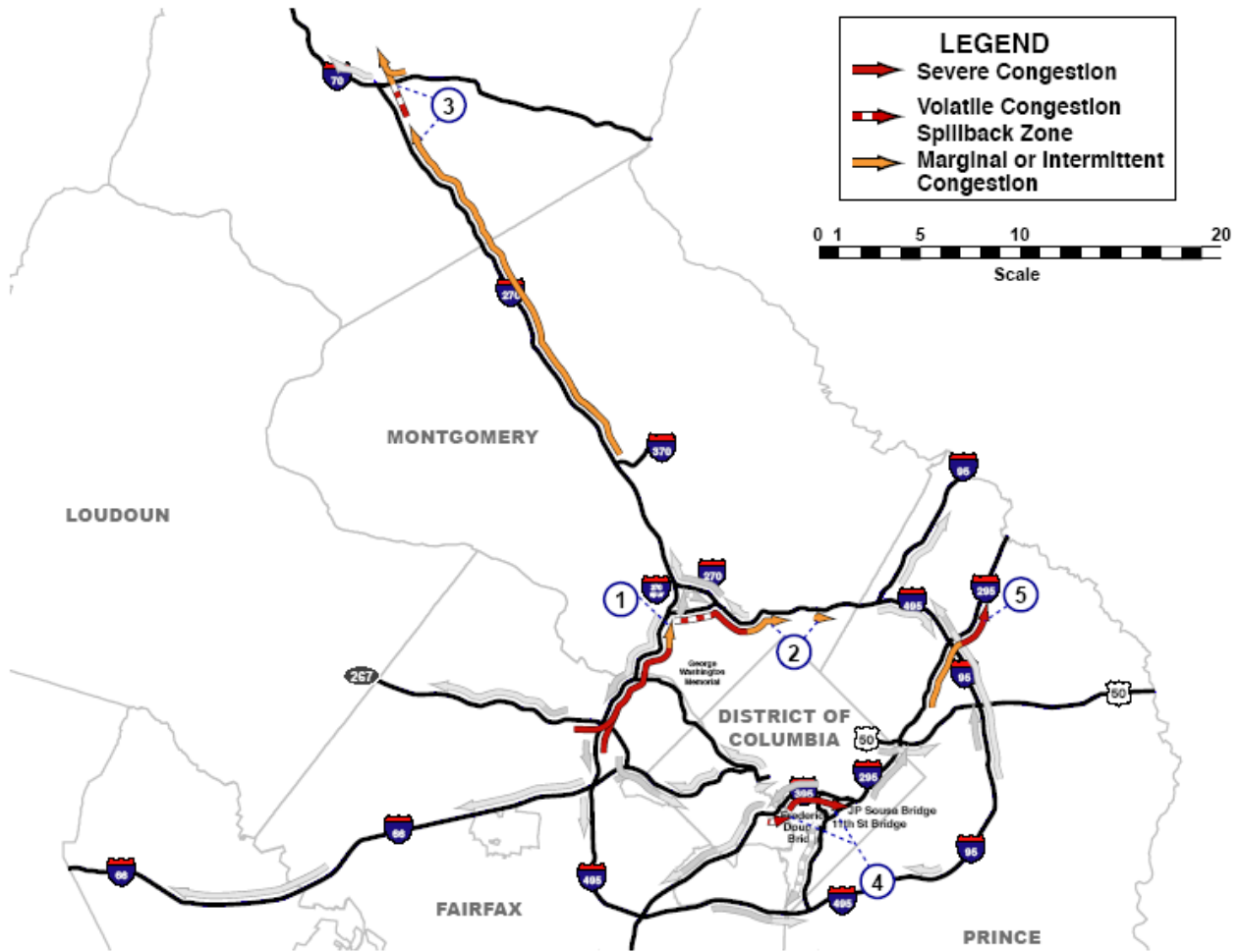

Figure 12: Longest Delay Corridors - Evening Peak Period (Spring 2008)

Site Name	Road Name	Time	Direction	From	To	Queue Length (miles)	Estimated Travel Time (minutes)	Estimated Speed (mph)	Estimated Delay (minutes)
Site #1	I-495	5:30 – 6:30	innerloop	VA 7	I-270 Spur	8	24	20	16
Site #2	I-495	4:30 – 5:30	innerloop	I-270 Spur	University Ave	10	24.5	25	14.5
Site #3	I-270	4:30 – 5:30	Northbound	I-370	I-70	23	34	40	11
Site #4	SE/SW Freeway	5:00 – 6:00	Northbound	VA 27	Pennsylvania Ave	5	15.5	20	10.5
Site #5	MD 295	4:30 – 5:30	Northbound	MD 450	MD 197	9.5	17.5	35	8

* Free flow travel times based on speed of 60 mph

Note: Congestion on I-495 in the vicinity of the Woodrow Wilson Bridge was excluded due to ongoing construction



2.1.1.4 Significant Changes from 2005 to 2008

Congestion is often location specific in nature. It is caused by bottlenecks at specific places, exacerbated by road construction or changes in nearby land use, and thus can improve or worsen quickly. Congestion generally is worsening throughout the region. However, congestion is not getting worse at every location; there are areas that have shown improvement when compared to data of previous years. Comparing the most recent survey (2008) to the previous four surveys helps identify major trends or changes in traffic conditions at specific locations. In some cases, changes could be attributed to the absence or presence of construction, or a decline in level of service can be attributed to an increase in demand. In other cases, added capacity was the reason for improved traffic flow. Still, in other cases, no specific reason could be linked to why traffic conditions improved or declined from previous years. **Figures 13 and 14** provide overview maps of significant changes in traffic congestion from 2005 to 2008. More detailed information can be found in **Appendix A: Significant Changes from 2005 to 2008 Freeway Aerial Surveys**.

Figure 13: Significant Changes (2005 – 2008) – Morning Peak Period

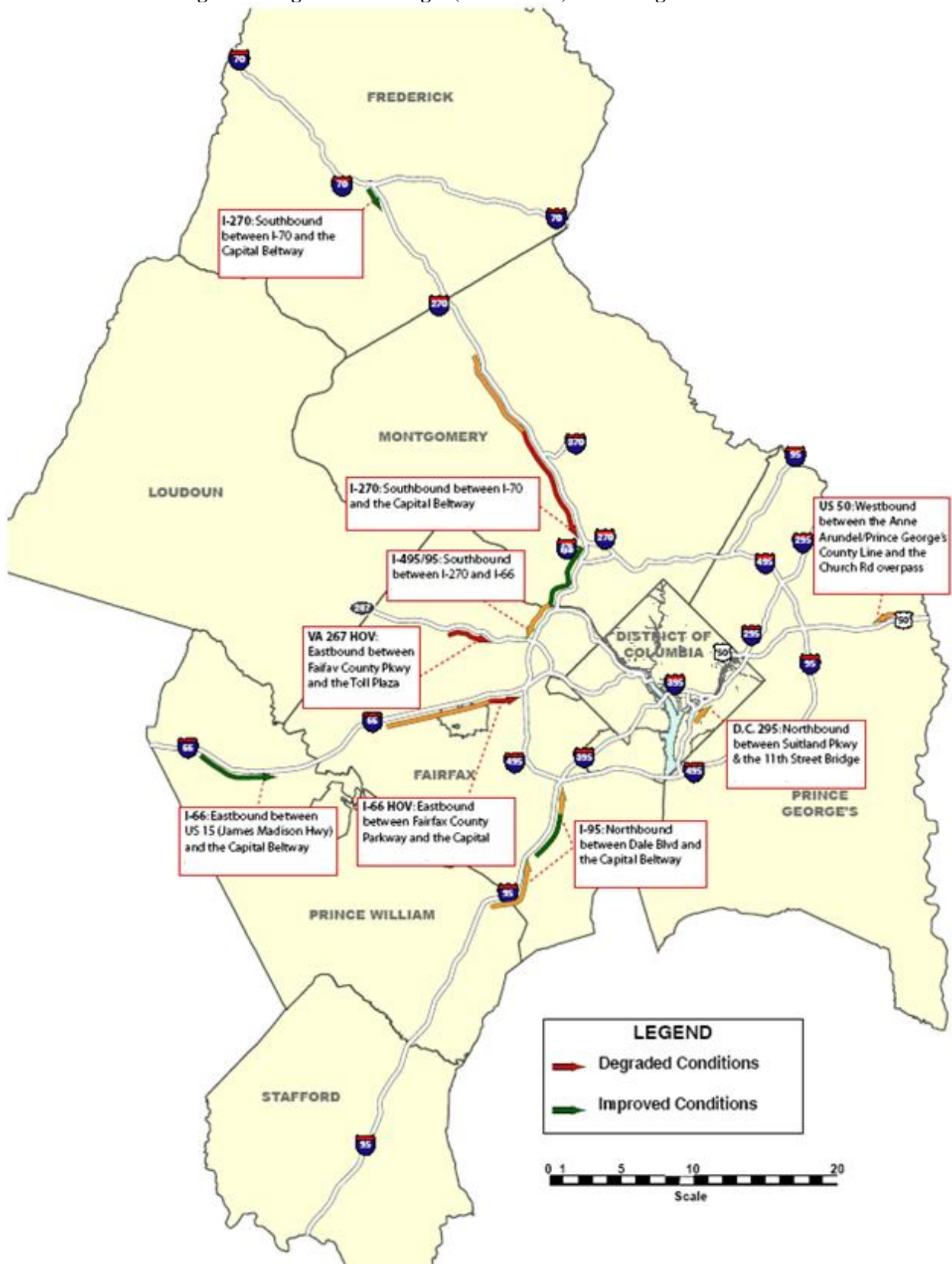
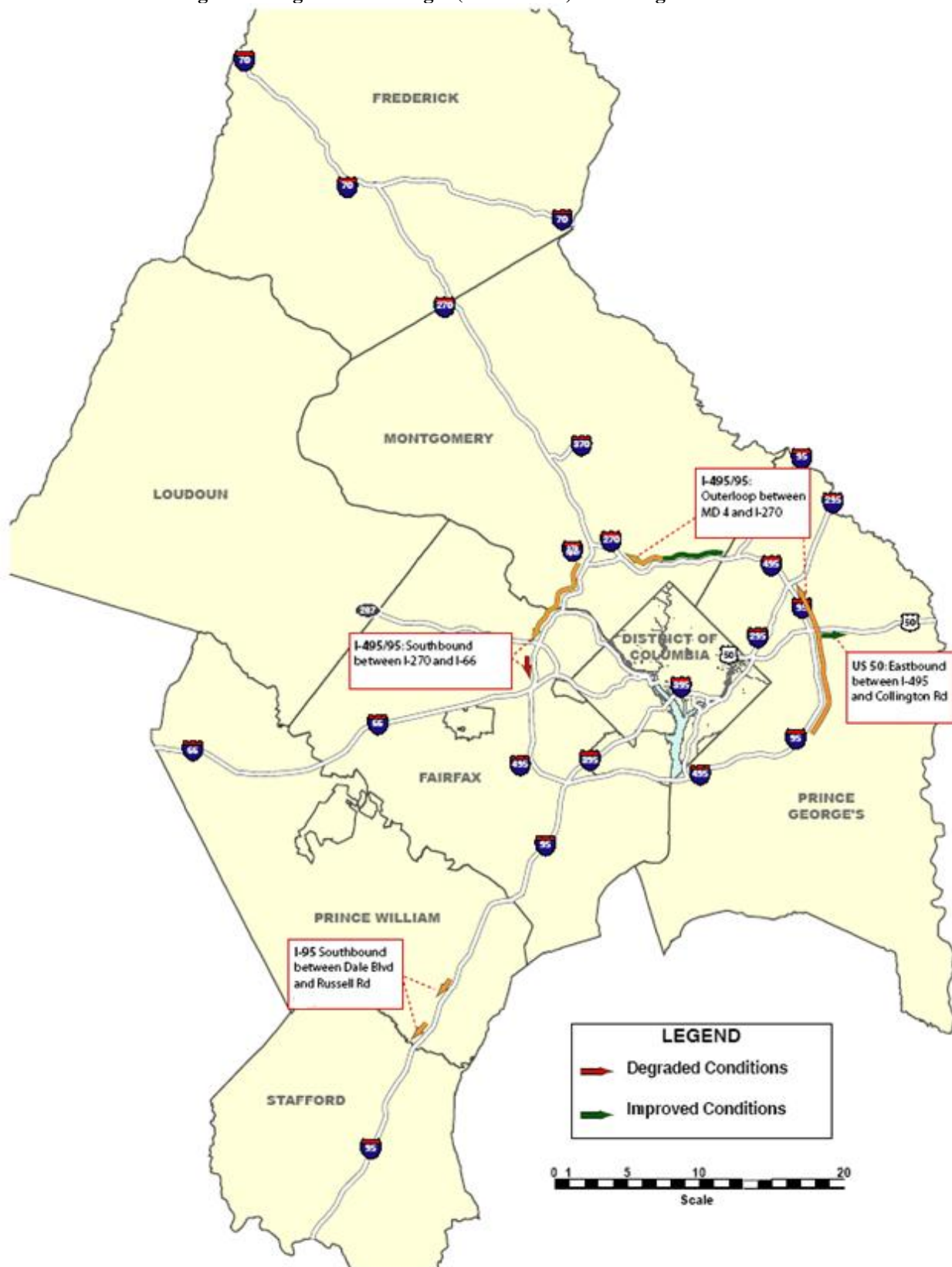

Figure 14: Significant Changes (2005 – 2008) – Evening Peak Period



2.1.1.5 Outlook for Freeway Congestion in the Region

The region has and is anticipated to continue having a vibrant economy with significant employment and population growth. This will lead to continuing freeway congestion. There are few opportunities for significant freeway capacity expansion in the region. Therefore, it remains important to address congestion through management strategies.

Strategies include the use of transit and alternative commute programs, land use development that supports the use of public transportation, congestion pricing, and many other congestion management strategies outlined in this report.

2.1.2 TPB ARTERIAL CONGESTION MONITORING

An arterial highway is defined as an urban interrupted flow roadway. Arterials are different than freeways in that they tend to have multiple ingress and egress points, intersections, fewer lanes, and lower speeds. Due to these characteristics, the congestion on arterials can be caused from reasons different than that of freeways.

Unlike for freeways, there is no comprehensive data set of roadway congestion for arterials in the region. There are a number of data sources that are informative, but data were collected different years, for different lengths of time, and using different methodologies. Therefore, for the purpose of identifying congestion on regional arterials, TPB has looked at these data sources plus has regularly undertaken specialized arterial data collection on a sample basis. The samples can then be used as a means to understand the congested conditions that may be occurring on similar arterial roadways throughout the region, as well as the ways congestion management strategies are impacting or may impact those types of congested conditions.

To identify the location, severity, and extent of congestion along selected National Highway System arterial highways in the region, a regional arterial highway performance monitoring study has been underway since FY 1999. Over the past decade staff has gathered data regarding travel time, speed, and data delay using Geographic Positioning System (GPS) technology, with data collection occurring in three-year cycles (e.g., 2002 routes repeated in 2005 and 2008). Data were collected between the hours of 1:00 PM and 8:00 PM, on Tuesdays, Wednesdays and Thursdays, avoiding public holidays or the day after a public holiday. A number of arterials were surveyed in the District of Columbia, Maryland, and Virginia, and level of service (LOS)¹³ was used to characterize the extent of congestion during the PM peak hour, PM peak period and PM off-peak period of travel¹⁴.

Each of the routes studied was driven by staff with the intent of verifying that the reference points were signalized intersections, and whether there were any turning movement restrictions at the beginning or end of each tour. The length of each segment and tour were verified. This was critical to assure the accuracy of the travel speeds that would be arrived at during the data analysis phase.

¹³ There are generally six levels of service, A through F. Level of service "A" is the best, describing primarily free-flow conditions, while level of service "F" is the worst, describing flow as unstable and significant traffic delay.

¹⁴ PM peak hour is 5:00 – 6:00 PM, PM peak period is 4:00 PM – 7:00 PM, and PM off-peak period is 1:00 – 4:00 PM and 7:00 – 8:00 PM.

Another motivation was to determine if the pre-designed tours could be driven within a 20-minute period or less. This condition would determine the number of complete bi-directional runs that could be completed in an hour. In the analysis phase, the number of runs per hour would determine if the data were statistically significant. During the verification phase, changes were made to the beginning and end of each tour, and reference points were modified as needed.

A tour is a section of a roadway, approximately 5 to 6 miles long, which can be driven in 20 minutes, but tours vary in length depending on location and travel accessibility. Staff assembled tours from the selected corridors. A segment is a section of a tour approximately a mile long, with similar operating characteristics, and with the limits made up of major intersecting roadways used to specify data collection operations within each tour.

The travel time data collected in the field were used in validating the tours and the segments. Changes were made to tours and segments where necessary. This enabled us to obtain 3 to 4 travel speed measurements during an hour using two data collection vehicles. Some corridors such as Virginia Route 7, Virginia Route 234, and 7th Street/Georgia Avenue were broken into multiple tours. Speed data were collected at the segment level, enabling us to identify potential bottlenecks along a tour.

Arterial monitoring shows some common themes and trends about general arterial congestion:

- There are competing demands of traveler mobility and accessibility to adjacent land uses affecting arterial operations.
- Growth and development can contribute to rapid worsening of congestion at specific locations.
- Intersections and driveways can cause slow-downs and backups along arterials.
- Arterials often experience spillover from freeways.
- Arterials tend to be heavily traveled in densely developed corridors.
- Traffic engineering improvements, such as extending a turn lane or traffic signal timing, can help soften the impacts of growth.
- By nature of design and other factors, arterials can be a mix of speeds, depending on things such as number of traffic signals, intersections, and lanes.
- Since the Washington region has a limited number of freeway lane miles, the region is especially dependent upon its arterial highways for mobility.
- Cars share the road with transit and delivery vehicles with frequent stops.

More detailed results of the studies can be obtained from MWCOG through request. Results of the most recent two studies (FY 2008 and FY 2009 studies) can be found in [Appendix B](#). The studies consider LOS E and F as “congested” conditions and calculate the percentage of miles under congestion for different time periods of a normal workday. According to the percentages of congested miles, congestion on studied arterials tended to become worse over years in the PM peak period (4:00-7:00 PM), especially during the PM peak hour (5:00-6:00 PM), while kept unchanged or relieved in the PM off-peak period (1:00-4:00 PM & 7:00-8:00 PM).

Although congestion occurs on arterials throughout the region, there are also common trends that are generally associated with the land uses and urban form surrounding the arterial. For the purposes of this report, we will classify these as metro core, inner suburban, and outer suburban arterials. Conditions in general for these types of roadways will be reported, and illustrative examples provided.

2.1.2.1 Arterials in the Inner Core

The characteristics of the inner core of a region, by their urban nature, can greatly impact the flow of traffic on the core's arterials:

- Pedestrian and transit access to densely populated land uses are a major focus of inner core roadways. Traffic speeds must be at a level that ensures pedestrian safety.
- The flow of traffic is more frequently interrupted by a higher concentration of signaled intersections and driveways/alleyways in the inner core.
- Intersections tend to be close together. If traffic is stopped at an intersection, sometimes backups can occur through the intersection behind it. In addition, traffic blocking an intersection could impact the flow of traffic on the cross street.
- There are not always turn lanes present, so drivers may have to wait while a car in front of them makes a turn.
- On-street parking necessitates slower traffic speeds. In addition, some inner core arterials experience worse congestion in the off-peak period because two lanes of capacity are lost due to on-street parking during the day.
- In many older areas, a grid pattern of streets allows for multiple travel routes at moderate speeds.

For example, many of these inner core characteristics play a role in the congestion on Connecticut Ave NW, between K Street NW and Nebraska Ave NW (shown in **Figure 15** in brown). When surveyed during the 2008 arterial monitoring study, the segment experienced the second lowest LOS (E) during the PM peak hour and the PM peak period. This segment of Connecticut Ave is a dense corridor of retail and commercial activity which attracts a large number of pedestrians and drivers searching for on-street parking.

Figure 15: Sample Inner Core Arterials Surveyed

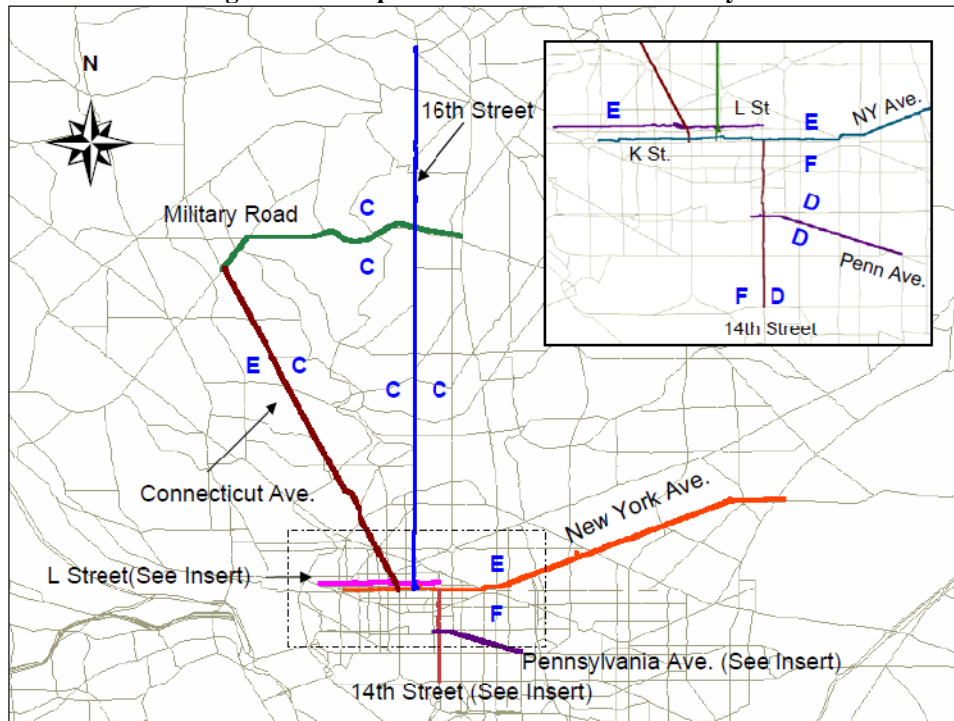

Congestion management strategies that can help manage congestion on core arterials include operations management strategies such as optimized traffic signal timing and traffic engineering improvements. Relevant demand management strategies include robust transit services in these densely populated areas, employer outreach of alternative commute programs, as well as improved pedestrian and bicycle facilities.

2.1.2.2 Arterials in the Inner Suburbs

Arterials in the inner suburbs have characteristics combined from that of the inner core and outer suburban arterials.

- Signalized intersections, especially the intersections of major arterial roadways, have capacity limitations, especially when there are high percentages of turning movements at those intersections.
- Traffic from both nearby offices and residences can cause congestion.
- There can be spillover from adjacent congested freeways.
- Strip retail and other “destination” retail activities are often located along arterials. In the inner suburbs the density of these uses is likely higher than that of the outer suburbs, and ingress/egress points are closer together. This could cause disruptions in traffic flow during peak times.
- Inner suburban areas have been experiencing welcome increases in pedestrians and transit usage in recent years, which must be considered in operations planning for arterials in these areas.

For example, these inner suburban arterial qualities are true of US 29, which extends from Arlington, VA to Centreville, VA (shown in [Figure 16](#)). Different colors represent different segments of US 29. The segment between M Street NW in DC and Harrison Street in Arlington is lined with several strip retail areas.

US 29 is also a major alternative commuting route of I-66, and it provides access to I-66 at several different locations. US 29 experiences spillover from several major freeways in the vicinity, including I-66 and the Beltway. The 2008 arterial monitoring study determined that the segments of US 29 from Park Road to M Street NW (eastbound) and from Park Road to Village Drive (westbound) experienced the worst LOS in the corridor during PM peak hour and PM peak period.

Figure 16: Inner Suburban Arterials Surveyed in VA

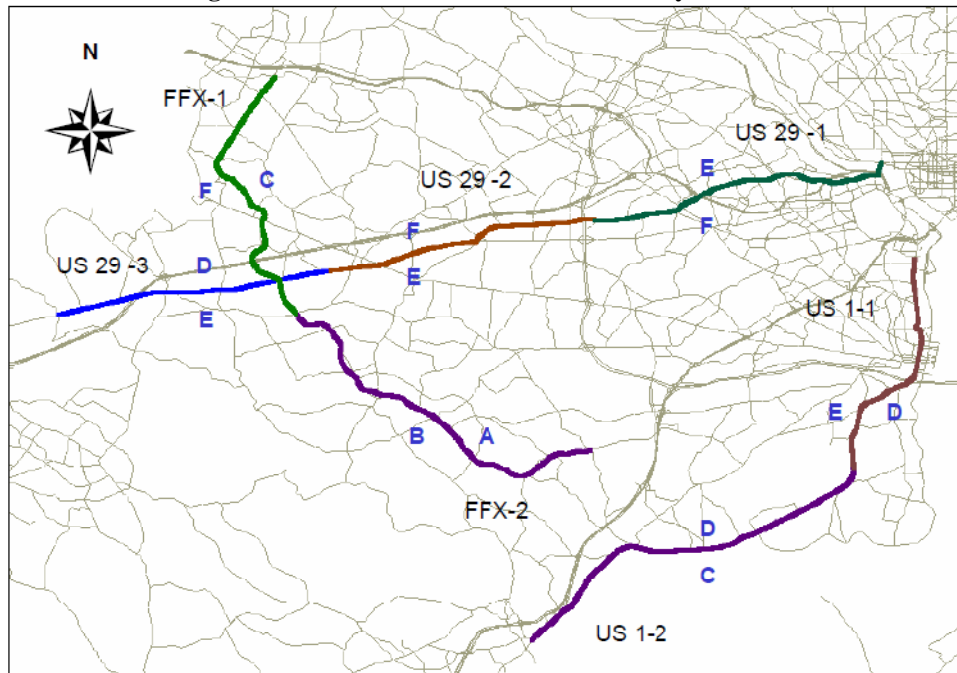

Georgia Ave, between Eastern Ave NW (DC boundary) and MD 28 also experiences situations typical of inner suburban arterials (shown in [Figure 17](#)). Georgia Ave links Aspen Hill area to Silver Spring, serving as one of the major commuting routes to and from DC for the communities between I-270 and I-95 in Montgomery County in Maryland. The southern part of the corridor connects to US 29 in Silver Spring, a major arterial cross the region. Georgia Ave also experienced spillover from the Beltway in Silver Spring. The worst LOS was observed during the FY 2008 study for the northbound segment from Eastern Ave NW to University Blvd for the PM peak hour.

Figure 17: Inner Suburban Arterials Surveyed in MD

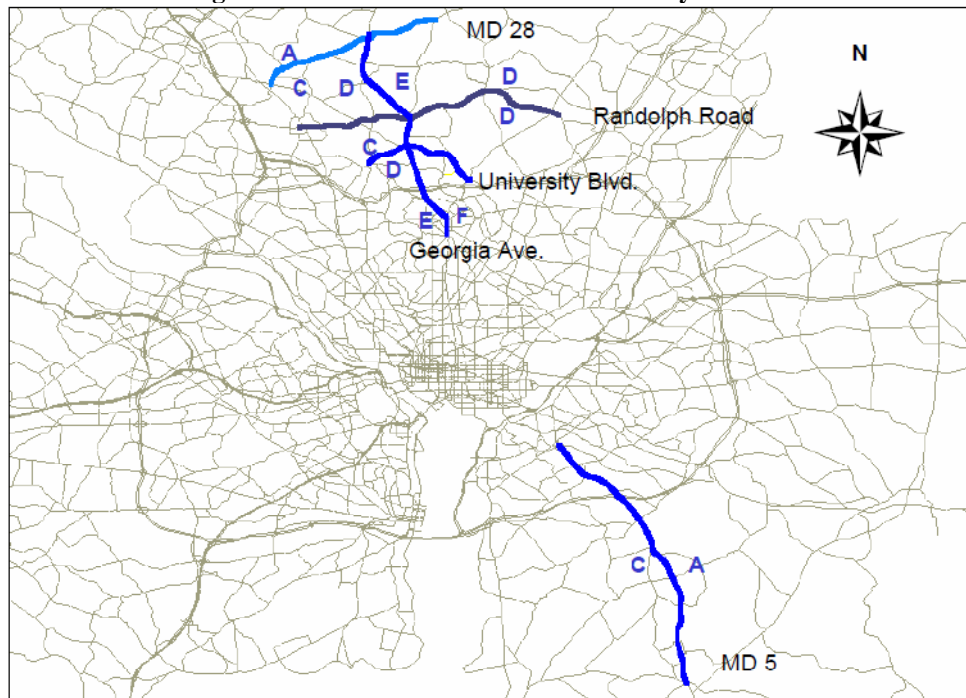

Congestion management strategies that can help inner suburban arterials include operational management strategies such as optimized traffic signals, operational management improvements on nearby freeways, and traffic engineering improvements. Often off-peak signal timing in inner suburban arterials can be worse than the peak hours, as a high number of people are moving in all directions and not with peak flow movement. Relevant demand management strategies include transit services, bus rapid transit, and Commuter Connections programs (especially employer-based programs).

2.1.2.3 Arterials in the Outer Suburbs

Arterials in the outer suburbs have their own unique characteristics:

- New development in the outer suburbs may quickly overwhelm the capacities of what were until recently lightly traveled rural roads.
- Because commute distances in the outer suburbs tend to be longer, peaking characteristics of traffic are much sharper.
- Transit services and pedestrian facilities are limited.
- Not unlike the inner suburbs, strip retail and other “destination” retail activities are likely to be located along outer suburban arterials. This could cause disruptions in traffic flow during peak times.
- Outer suburban arterials can also experience spillover from major freeways. This is especially expected during the morning and evening peak period when commuters drive to and from the inner core for work.

For example, MD144 between Waverly Road and Monocacy Boulevard in Frederick County experiences spillover from two major roadways that bypass in Frederick: I-70/I-270 and US 340/US 15 (Catoctin Mountain Highway).

The northern section of VA 7 between Georgetown Pike and VA 653 links Fairfax County to Leesburg. It is a major commuting route which connects to VA 28. The stretch of arterial from the Loudoun County line to Sterling has seen much commercial and retail development over the past several years.

Congestion management strategies that can help outer suburban arterials include operational management strategies such as bottleneck removal, dedicated turn lanes, and other traffic engineering improvements. Relevant demand management strategies include park-and-ride lots, commuter bus and rail services and Commuter Connections programs (especially employee-focused programs).

2.1.2.4 Traffic Signal Timing

Delays occurred at signalized intersections accounted for a significant portion of overall arterial and urban street delays. Improving traffic signal timing has been identified as a CLRP priority area.

The TPB has conducted two surveys of the status of signal optimization in [2005](#) and [2009](#). The 2009 survey found that of the total 5,400 signalized intersections in the region, 80 percent were computer optimized (56%) or checked or adjusted (24%). If a weighted average methodology was used to describe the results, giving half weights to non-computer methods, then 68 percent of signals were “optimized”. This percentage is the same as what was found in 2005 but better than the 2002 result, 45 percent.

Even though the percentage of optimized signals kept unchanged from 2005 to 2009, the region may have better results than that may indicate because: 1) the most critical signals in many cases were being checked and optimized even more frequently than once every three years; 2) all major agencies (with more than 50 signals) reported that they had optimized or checked significant numbers of their signals within the reporting period – no major agency reported not optimizing or checking; and 3) there were anecdotal reports of more resources annually being put into optimization in recent years than in previous years – this will be beneficial if continued.

2.1.2.5 Improving Congestion on Arterials

Adding capacity on arterials to reduce congestion is seldom feasible, as many arterials are already built to capacity with development on either side. However, as noted above, there are demand management and operational management strategies that could offer solutions. The addition of express bus or other types of public transportation along an arterial could decrease the amount of cars on the road. Pedestrian and bicycle improvements, such as the implementation of a new bike facility along the arterial can provide an alternative option for travelers. Operational improvements can include the addition of turn lanes, to reduce the amount of back-ups at an intersection, or the creation of additional lanes. Traffic signal timing optimization is also important in ensuring the appropriate movement of vehicles at intersections.

2.1.2.6 Potential for Future Data and Analysis of Arterial Congestion

The arterial congestion data available for reference by this report were limited. Data were satisfactory in addressing the core CMP requirement of understanding where and how demand and operational congestion management strategies may be applied to these congested situations, but additional or more detailed data would have been informative. For future reports, the region may explore compilation or development of alternative or emerging data sources for arterials. Examples are the I-95 Corridor Coalition/INRIX data and Bluetooth data. The INRIX data cover about 194 centerline miles of arterials in this region and third-party validations are pending. Bluetooth technology could be another opportunity for more comprehensive arterial monitoring as it could provide continuous monitoring and more probe samples.

2.1.3 I-95 CORRIDOR COALITION TRAFFIC MONITORING

2.1.3.1 A New Data Source for Highway Performance Monitoring

Since July 1, 2008, a portion of freeways and major arterials in the Metropolitan Washington Area have been monitored by the [I-95 Corridor Coalition's Vehicle Probe Project](#). The data coverage is shown in **Figure 18**. This project is a groundbreaking initiative and collaborative effort among the Coalition, University of Maryland and INRIX, Inc. providing comprehensive and continuous real-time travel information to members. The objective of this project is to acquire travel times and speeds on freeways and arterials using probe technology. While the dominant source of data is obtained from fleet systems that use GPS to monitor vehicle location, speed, and trajectory, other data sources such as sensors may also be used. The INRIX system fuses data from various sources to present a comprehensive picture of traffic flow.

As an affiliate member of the Coalition, the National Capital Region Transportation Planning Board has been granted the access to the data collected in the Vehicle Probe Project. This is an innovative data source for both highway performance monitoring and regional planning. The continuous real-time speed and travel time data have been integrated into the Regional Integrated Transportation Information System (RITIS) and intensely used by the Metropolitan Area Transportation Operations Coordination (MATOC) program. The archived data is of particular interest of the TPB and a valuable source for congestion monitoring and evaluation for the Congestion Management Process, as well as for validation of the regional travel forecasting model.

The archived data contain the following variables¹⁵:

- *TMC Code*: The TMC (Traffic Message Channel) code is an industry convention that defines a specific section of road. The attributes of each code are defined by a consortium consisting of TeleAtlas and Navteq (the two major digital map providers) that agree, then publish the location data for each code. INRIX reports at the TMC level, so each TMC code will have a unique speed value. The [I-95 project Interface Guide](#) addresses TMC codes in detail in section 4 - including how to interpret the 9 digit TMCs. TMC Code usually changes at the gore of a ramp, or at boundaries, etc.

¹⁵ I-95 Corridor Traffic Monitoring website <http://i95.inrix.com>.

Figure 18: I-95 Corridor Coalition/INRIX Data Coverage in the National Capital Region

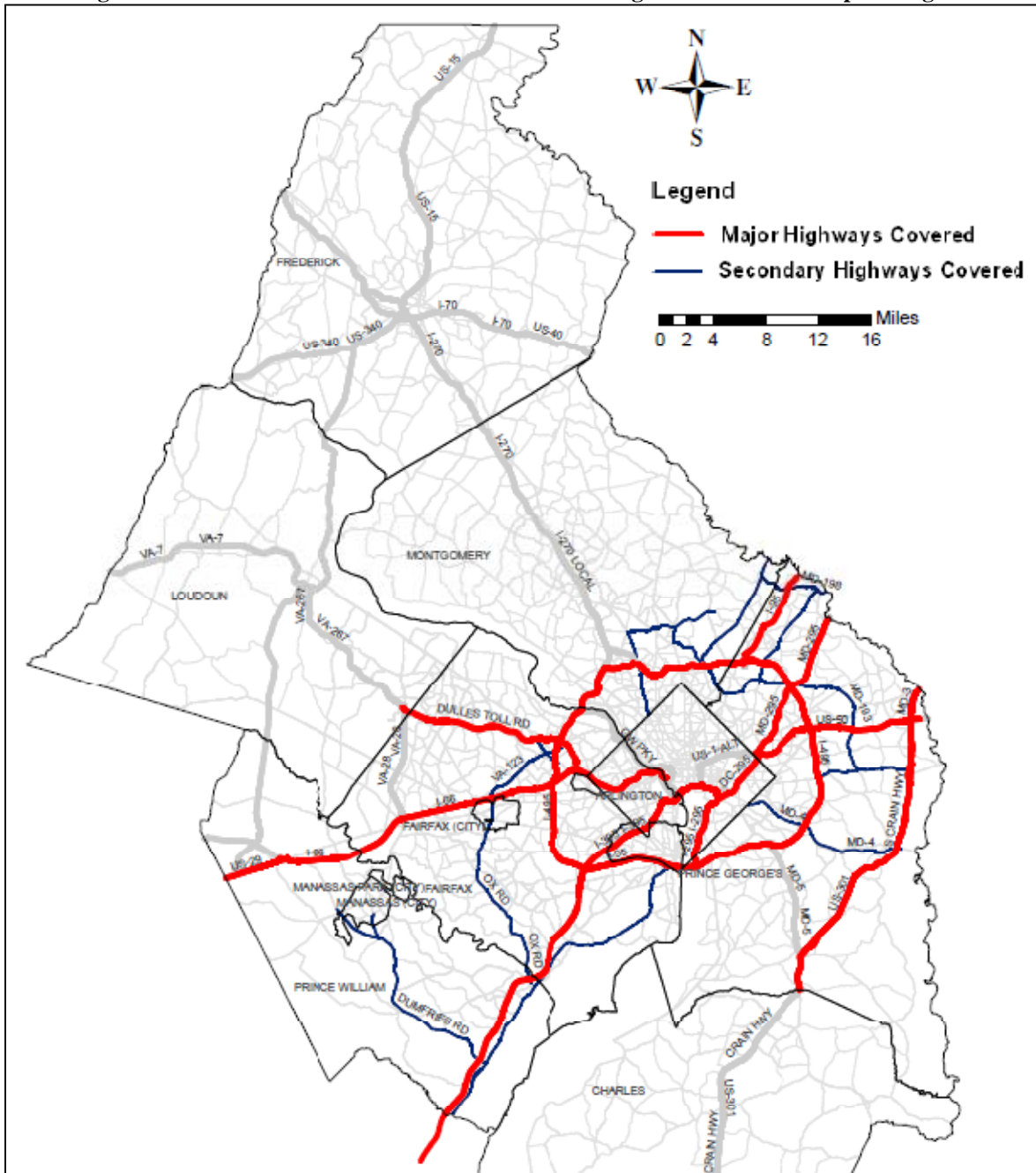

- *DTK*: Date Time Key is the number of minutes elapsed since 1/1/2001.
- *TimeUTC*: The date and time for which INRIX is conveying a speed value, in UTC (Coordinated Universal Time). This will be at five minute intervals for the period of archive data being requested. UTC is 4 hours ahead of Eastern Daylight Time and 5 hours ahead of Eastern Standard Time.
- *Speed*: The INRIX-reported speed on a specific TMC code.

- *Average Speed*: The average speed expected on a TMC code for a specific hour of day, and day of week.
- *Reference Speed*: The calculated “free flow” mean speed for the roadway segment (TMC) in miles per hour (capped at 65 miles per hour). This attribute is calculated based upon the 85th-percentile point of the observed speeds on that segment for all time periods, which establishes a reliable proxy for the speed of traffic at free-flow for that segment.
- *Score*: In many ways analogous to the C_Value on a tighter range. 30 represents pure real-time data; 20 represents a blend of real-time, predictive and/or historical data (where real-time data is weighted most heavily); and 10 represents pure historical data.
- *TravelTimeMinutes*: The travel time, in minutes that it takes to travel the entire distance defined by the TMC code based on the current speed - the length of the TMC can be found in the aforementioned TMC table.
- *C_Value*: A Confidence Value (range 0 - 100) that will help individual agencies determine whether the INRIX value meets their criteria for real-time data. It is expected that guidelines will be issued in the near-term specific to how this value can best be interpreted and used. The University of Maryland or INRIX can provide the latest C_Value guidance as to how to interpret this value. For additional information on the C_Value, see the I-95 Interface Guide

Some advantages and disadvantages of the I-95 Corridor Coalition/INRIX data are summarized as follows.

Advantages of the Archived I-95 Corridor Coalition/INRIX Data

- This data source provides **continuous (24/7/365) monitoring for every covered road segment** (called Traffic Message Channel or TMC). This enables data users to not only capture the normal (or robust) conditions of highways, as the Skycomp aerial surveys and arterial floating car travel time studies do, but also to gain insights into unusual conditions of highway congestion (e.g. incidents or inclement weather related conditions). In addition, temporal variations of highway performance can be also reflected for any predefined time periods. All of this makes it possible to look beyond traditional congestion analysis and to further carry out travel time reliability analysis for our region.
- As **probe vehicle data**, the I-95 Corridor Coalition/INRIX data overcome some typical uncertainties of location-fixed detector data in measuring vehicle speed and travel time, as revealed by numerous studies. Location fixed detector data usually have to rely on assumptions of vehicle length and/or road segment length to indirectly estimate segment vehicle speed and travel time. On the contrary, probe vehicles directly measure segment speed and travel time thus they could provide more realistic measures.
- **This data source has a geo-reference**, called Traffic Message Channel or TMC, so analysis results can be conveniently and accurately visualized on a Geographic Information System (GIS) network. The TMC is a specific application of the FM Radio

Data System (RDS) used for broadcasting real-time traffic and weather information¹⁶. The definition of TMC is based on logical breaks in facilities where one would expect the potential for differing traffic conditions, such as an interchange or major at-grade intersections. The length of TMC is usually 1-3 miles for urban freeways and 0.5-3 miles for urban arterials (3-10 miles for rural freeways and 2-5 miles for rural arterials).

Disadvantages/Caveats of the Archived I-95 Corridor Coalition/INRIX Data

- **No traffic volume or density parameters collected in the data source.** This is a typical deficiency common to almost all probe vehicle data. As a consequence, “congestion” may not be realistically reflected in a few cases. An example is low speeds are usually observed on freeways during a snowstorm but these low speeds are usually a result of slippery road surface and cautious driving behavior rather than high density of vehicles. Thus congestion analysis should pay attention to those possible interpretations of observed subnormal speeds.
- **Some technical details regarding data collection and processing remain unrevealed,** because this is a proprietary data source provided by the private sector. In order to ensure the quality of data, however, the I-95 Corridor Coalition contracts with University of Maryland to carry out ongoing third-party data validation studies. There have been two validations for freeway data in our region from 2008 to 2009, and the results indicated that the data quality satisfying the standards specified in the contracts^{17,18,19}.
- **Limited coverage in the National Capital Region.** Since the Vehicle Probe Project only covers highways determined to have a regional impact along the I-95 corridor from New Jersey to South Carolina, some very important highways in the National Capital Region are not covered by this effort, including I-270 and I-70. Nonetheless, this project does cover about 200 centerline miles of freeways and 190 centerline miles of arterials across the TPB member jurisdictions (**Figure 18**). This includes coverage made available through VDOT’s efforts: Dulles Toll Road, I-66 inside the Beltway, Virginia Route 7 and Route 123 around the Tysons Corner. The Congestion Management Process takes the advantage of this groundbreaking data source and analyzes congestion and reliability for covered highways in the region. As Maryland State Highway Administration has been seeking additional coverage beyond the “core coverage” of the Vehicle Probe Project, it is expected that more facilities in Maryland will be covered in the near future. The Congestion Management Process will conduct congestion and reliability analyses once the additional coverage is available, and the results will be presented in the next update of the CMP Technical Report.

¹⁶ For more information about the TMC, refer to the *I-95 Interface Guide*, January, 2010.

http://www.i95coalition.net/i95/Portals/0/Public_Files/uploaded/Vehicle-Probe/I95_Interface_Guide_Jan_2010.pdf

¹⁷ I-95 Corridor Coalition, I-95 Corridor Coalition Vehicle Probe Project: Validation of INRIX Data July - September 2008, Final Report. January 2009.

¹⁸ I-95 Corridor Coalition, I-95 Corridor Coalition Vehicle Probe Project: Validation of INRIX Data, Monthly Report, Virginia, June 2009.

¹⁹ I-95 Corridor Coalition, I-95 Corridor Coalition Vehicle Probe Project: Validation of INRIX Data, Monthly Report, Maryland, May 2009.

Leveraged by the archived I-95 Corridor Coalition/INRIX data, the 2010 CMP Technical Report is able to conduct qualitative travel time analysis for the covered highways in the National Capital Region. This report employs Travel Time Index and Mile-Hour of Congestion for congestion analysis and Planning Time Index and Buffer Time Index for travel time reliability analysis. These analyses use all 2009 (calendar year) data that contain hundreds of millions records, and the results are presented as follows.

2.1.3.2 Travel Time Index

Travel time index is the ratio of actual travel time over free flow travel time obtained for a roadway segment during a specific time period. The travel time index expresses the average amount of extra time it takes to travel in a predefined time period relative to free-flow travel.

A travel time index of 1.3, for example, indicates a 20-minute free-flow trip will on average take 26 minutes (1.3 times of free flow travel time) during that time period, a 6-minute (30 percent) travel time penalty. Travel time index is widely used by public agencies and private sectors, e.g., Texas Transportation Institute’s Urban Mobility Report²⁰ and INRIX’s National Traffic Scorecard²¹.

Maps of Travel Time Index

Travel time index of each road segment (TMC) for the following 13 different time periods in 2009 are visualized on the regional map, which can be found in **Appendix C**. An example of the maps is shown below for non-holiday workday morning peak period, 6:00 – 10:00 AM (**Figure 19**).

All Time:	24/7/365
Non-Holiday Workday AM Peak Period	6:00 – 10:00 AM
▪ Non-Holiday Workday AM Hour	6:00 – 7:00 AM
▪ Non-Holiday Workday AM Hour	7:00 – 8:00 AM
▪ Non-Holiday Workday AM Hour	8:00 – 9:00 AM
▪ Non-Holiday Workday AM Hour	9:00 – 10:00 AM
Non-Holiday Workday PM Peak Period	3:00 – 7:00 PM
▪ Non-Holiday Workday PM Hour	3:00 – 4:00 PM
▪ Non-Holiday Workday PM Hour	4:00 – 5:00 PM
▪ Non-Holiday Workday PM Hour	5:00 – 6:00 PM
▪ Non-Holiday Workday PM Hour	6:00 – 7:00 PM
Non-Holiday Workday Midday	10:00 AM – 3:00 PM
Weekend	10:00 AM – 7:00 PM

As mentioned earlier, not all major highways in our region is covered by the I-95 Corridor Coalition’s Vehicle Probe Project – the reason why travel time index is only shown for a portion of highways on the map. For covered highways, the map clearly identified some very congested road segments (with travel time index > 2 and shown in red) in the region during the AM peak period, including segments on I-395 northbound, inner loop from I-395 to I-66, I-66 eastbound

²⁰ Urban Mobility Report, Texas Transportation Institute: <http://mobility.tamu.edu/ums/>.

²¹ INRIX National Traffic Scorecard, INRIX, Inc. <http://scorecard.inrix.com/scorecard/>.

from Fairfax County Pkwy to the Beltway, etc. Note that the physically separated HOV lanes along I-95 and I-395 were significantly less congested than the general purpose lanes.

Figure 19: Sample Map of Travel Time Index - Workday AM Peak 6:00-10:00 AM (2009) for the I-95 Corridor Coalition Covered Highways

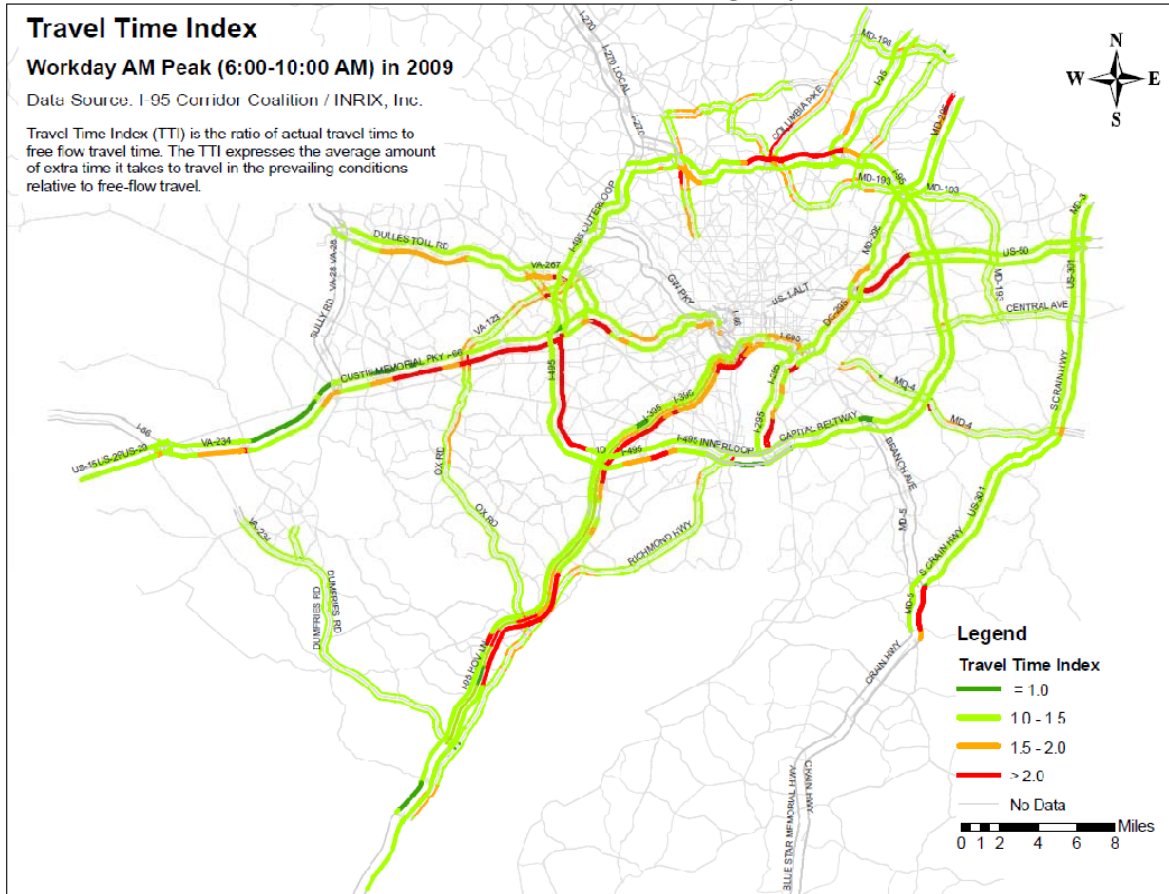

Month-to-Month Travel Time Index

Travel time index of freeway segments are used to draw a summary of all the covered freeways in the region²². This was done by weighted travel time index – the weight is segment length, i.e., the overall travel time index = sum of (segment travel time index * segment length) / total length of all segments.

Figure 20 shows the month-to-month travel time index variations of both peak periods and all day for the 12 months in 2009 and the last 6 months in 2008 (data became available in July 2008). **Figure 21** shows monthly travel time index of AM peak, PM peak and all day for all months in 2009.

²² Freeway data has been validated and the covered freeways represent the majority of the region’s freeway system. No arterial data has been validated as of April 2010 and the covered arterials only a small portion of the region’s arterials. Therefore, only freeway data were used for the “regional” summary analysis.

Figure 20: Travel Time Index in 2008 and 2009 for the I-95 Corridor Coalition Covered Freeways

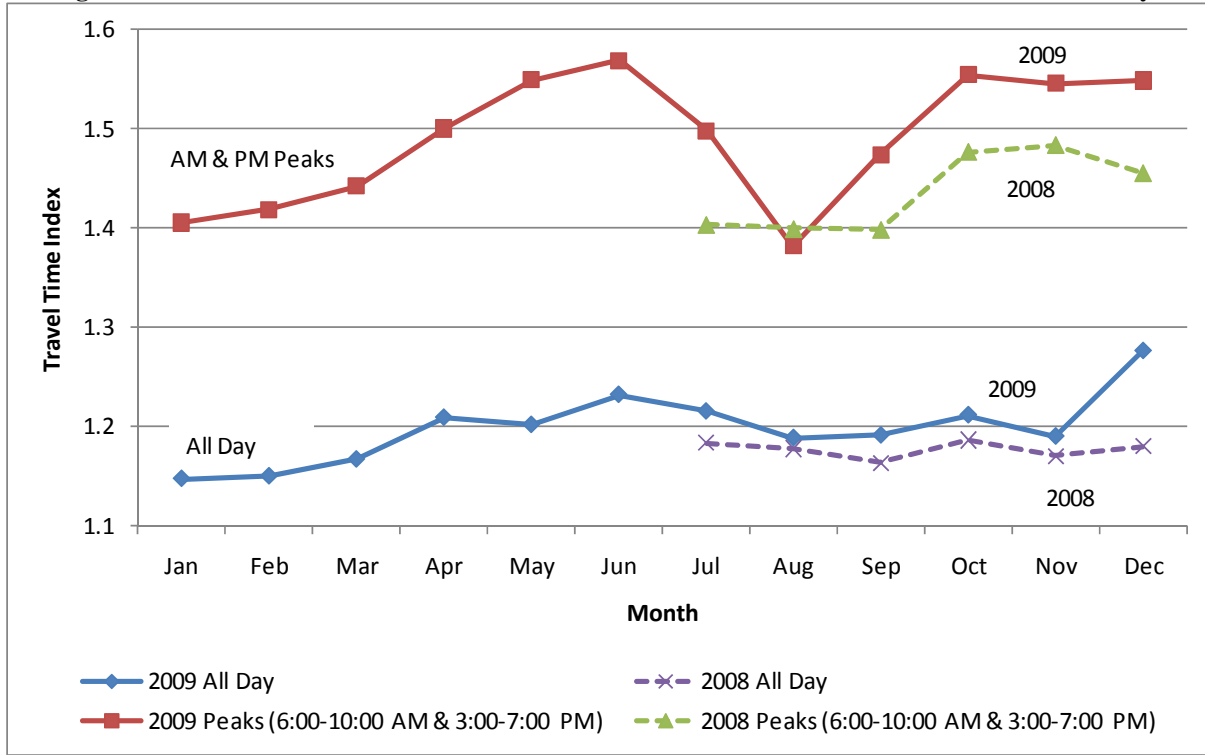
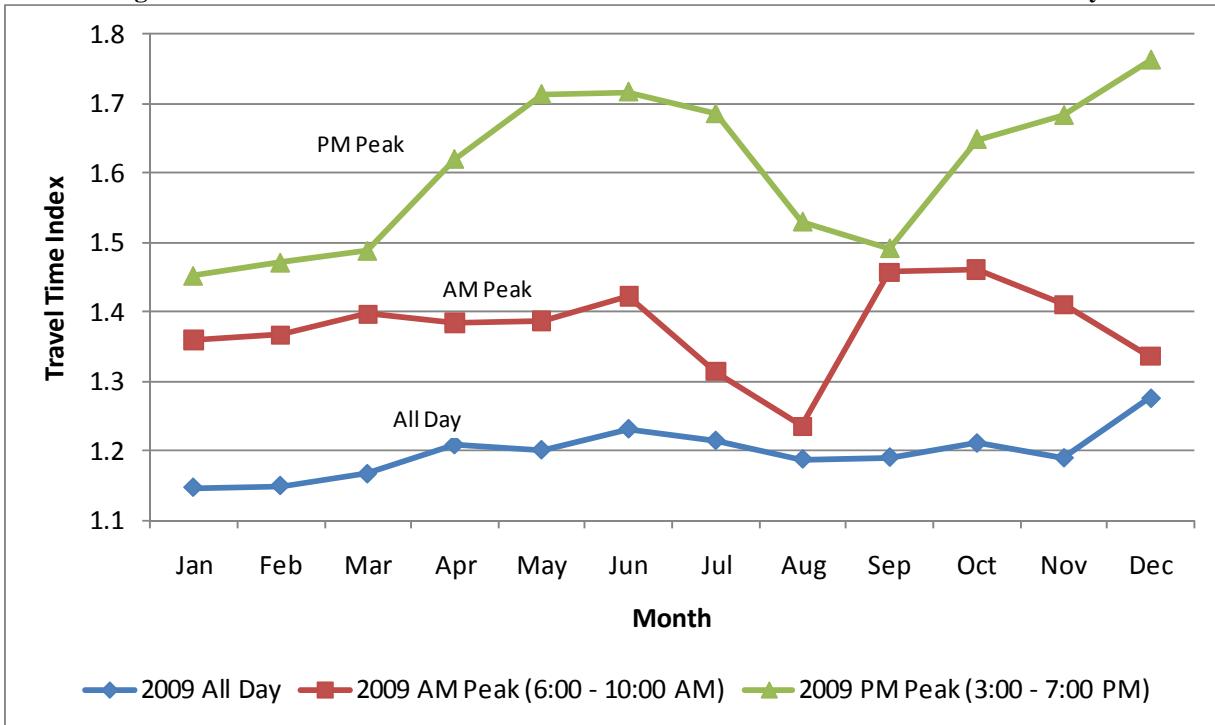

Figure 21: Travel Time Index in 2009 for the I-95 Corridor Coalition Covered Freeways



Compared to the last 6 months of 2008, each month in the second half of 2009, especially December, experienced more extra travel time on the freeways covered by the I-95 Corridor Coalition (with one exception for August peaks). A possible cause of this systematic difference would link to the improvement of the overall economic situation in the second half of 2009 from a year earlier, when the economic was experiencing the worst conditions. The sharp increase of travel time index in December 2009 for “All Day” from a year ago has another explanation, which will be explained later.

The 2009 month-to-month travel time index clearly depicts the seasonal variations of congestion on the I-95 Corridor Coalition covered freeways (Figure 21):

- PM peak had the worst congestion in a day. It kept increasing from January through June then dropping until September, and then increasing again to the end of the year.
- AM peak congestion was almost stable from January to June, and then dropped to the lowest level in the year in August.
- AM and PM peak congestion had different variations. The difference was amplified from September to December when PM congestion increasing while AM decreasing.

There is a caveat regarding the sharp increase of “All Day” travel time index from November to December in 2009. Travel time index only expresses the magnitude of extra travel time compared to free flow travel time. While extra travel time is usually a result of congestion, other causes, such as inclement weather, could also result in excess travel time. This was the case for December 2009, during which the region experienced a strong snow storm starting from December 19. Figure 22 compares travel time index values for the same weekdays of December 2008 and December 2009. The impact of the snow storm is clearly reflected in the comparison. In addition, this comparison also identifies the impact time period of this snow storm, from December 19 (Saturday) to 23 (Wednesday).

Figure 22 : Comparison of Travel Time Index in December 2008 and 2009 for the I-95 Corridor Coalition Covered Freeways

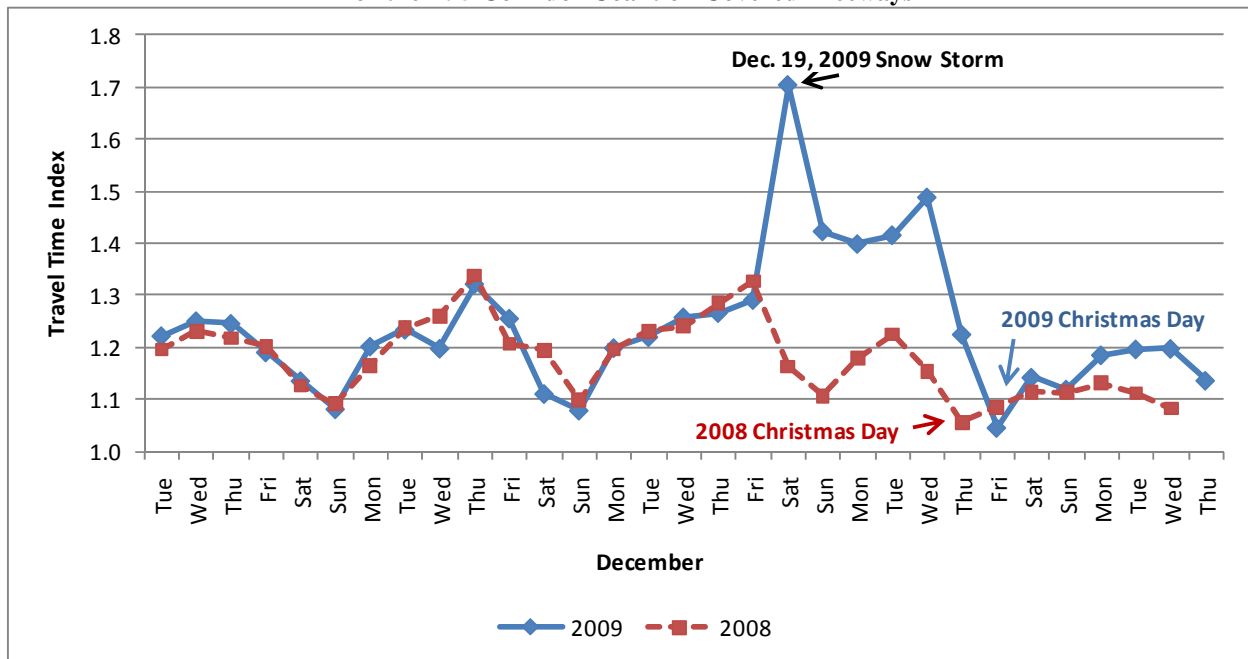

Time of Day and Day of Week Travel Time Index

Figure 23 presents travel time index by time of day (hour) and day of week for all the I-95 Corridor Coalition covered freeways within TPB member jurisdictions in 2009 (note “7a” in the figure refers to the 7:00-8:00 AM hour, and “7p” refers to the 7:00-8:00 PM hour, etc.). Some noteworthy findings include:

- Tuesday morning and Friday afternoon were the busiest AM and PM peak periods;
- Friday 4:00-5:00 PM remained the most congested hour of the week, with a travel time index of 1.93;
- Tuesday 8:00-9:00 AM remained the most congested morning rush hour, with a travel time index of 1.63;
- For the same workday, the morning peak hour was less congested than the evening peak hour;
- Friday evening peak hour (4:00-5:00 PM) was one hour earlier than the peak hour (5:00-6:00 PM) observed in the other four workdays;
- Saturday had more traffic than Sunday, but both weekend days were generally less congested than workdays, especially during peak periods.

Figure 23: Travel Time Index by Time of Day and Day of Week (2009) for the I-95 Corridor Coalition Covered Freeways

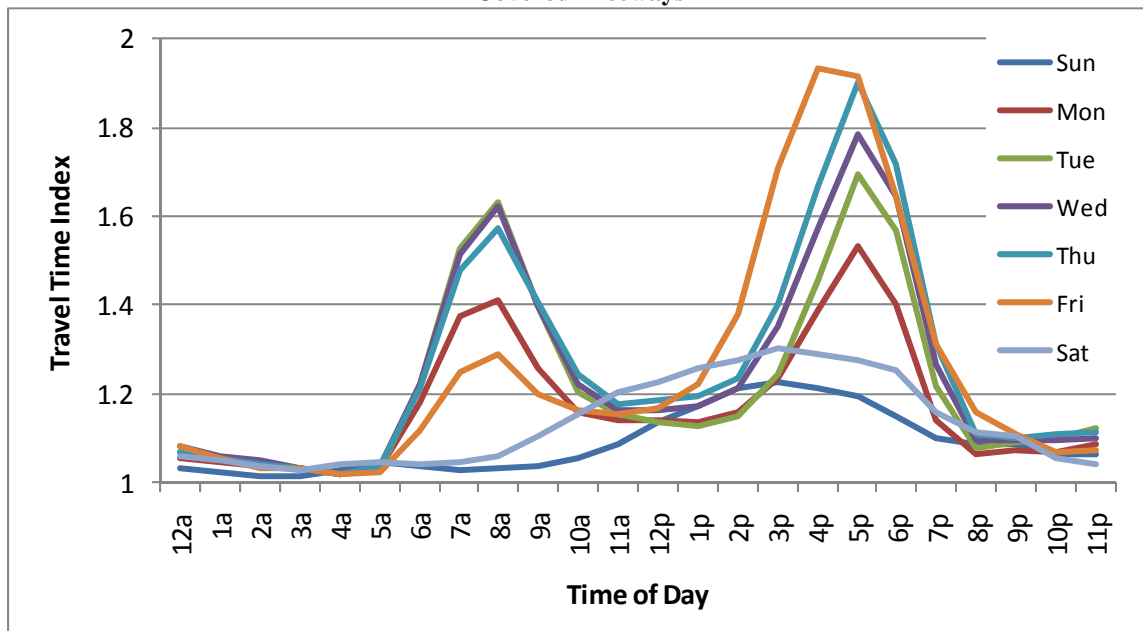

2.1.3.3 Mile-Hour of Congestion

While travel time index is a “relative” indicator of congestion intensity, mile-hour of congestion is an “absolute” gauge of congestion. We use an industry rule of thumb that considers congestion occur when speed is equal to or less than 50 percent of the free flow speed.

There was total 182,000 mile-hours of congestion in 2009 and 118,000 mile-hours of congestion for workday AM and PM peak periods – the latter accounted for 65 percent of total congestion. Comparing the second halves of 2008 and 2009, it revealed that the mile-hours of congestion of peak periods increased 14 percent and that of all day increased 24 percent – faster increase in non-rush hours – as shown in [Figure 24](#).

Figure 24: Mile-Hours of Congestion for the I-95 Corridor Coalition Covered Freeways

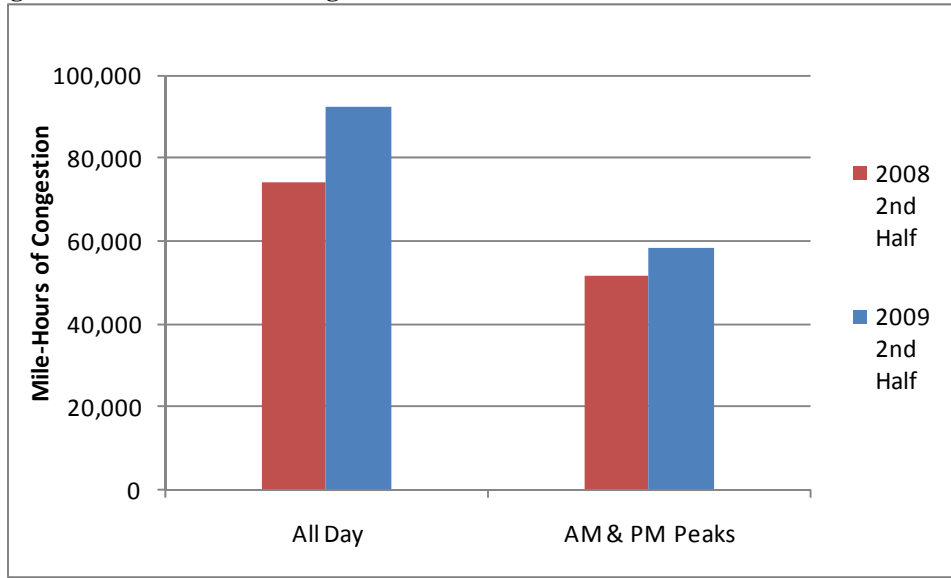

Dividing the number of mile-hours of congestion by the total length of the covered freeway segments, we obtain hours of congestion per mile. [Figure 25](#) shows the hours of congestion per mile in each month in the 18 months from July 2008 to December 2009. The variation pattern is similar to what was found in [Figure 20](#) (monthly travel time index) but with “All Day” had higher values since hours of congestion is an “absolute” measure of the extent of congestion.

Figure 25: Hours of Congestion per Mile per Month for the I-95 Corridor Coalition Covered Freeways

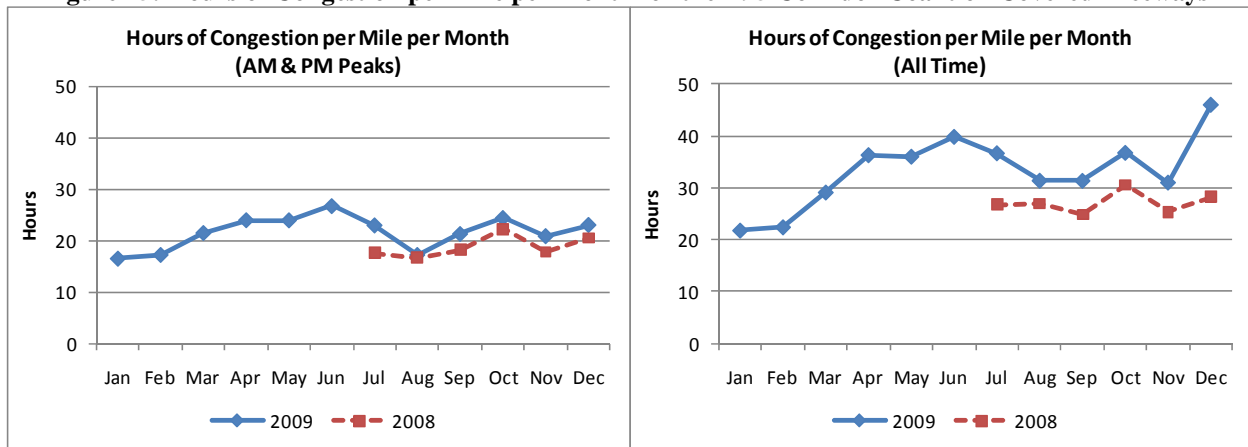

2.1.3.4 Planning Time Index

To most travelers, everyday congestion, particularly peak period congestion, is common and they often adjust their schedules or plan extra time to allow for the expected delays; what trouble travelers most are unexpected or much-worse-than-expected delays, which can be caused by incidents, inclement weather and temporal work zone, etc. Travelers thus want travel time reliability - a consistency or dependability in travel times, as measured from day to day or across different times of day²³ - to just avoid being late.

To quantify travel time reliability, this report adopts planning time index and buffer time index two measures. This section presents planning time index and the next buffer time index.

Planning time index is the ratio of 95th percentile travel time over free flow travel time. It expresses the extra time a traveler should budget in addition to free flow travel time in order to arrive on time 95 percent of the time. The difference between 95th percentile travel time and free flow travel time is called planning time.

Maps of Planning Time Index

Planning time index of each road segment (TMC) for the 13 different time periods (used for maps of travel time index) in 2009 is visualized on the regional map, which can be found in **Appendix D**. An example of the maps is shown below for non-holiday workday morning peak period, 6:00 – 10:00 AM (**Figure 26**).

Compared to travel time index, planning time index usually has higher values²⁴. This is indeed true and very reasonable, as the 95th percentile travel time usually is longer than the average travel time during the same time interval. This is why high planning time index values (> 3, shown in red) are very common in the sample map, which is for a workday morning peak period. Such planning time index values are not unique for the National Capital Region, similar values were also found elsewhere, such as the Metropolitan Atlanta area²⁵.

²³ Federal Highway Administration, *Travel Time Reliability Measures*,
http://ops.fhwa.dot.gov/perf_measurement/reliability_measures/index.htm

²⁴ Readers should be cautious, however, in interpreting the segment (TMC) – based planning time index calculated in this report. Route or corridor level of planning time index was not calculated thus one should not interpret the segment-based index as a route or corridor-based index. For example, if all the segments of a corridor have planning time index of 3 (e.g. I-66 EB from Fairfax Parkway to the Beltway in the sample map), the corridor has a large chance of having a planning time index less than 3. A simple explanation is the worst condition of each segment on the corridor does not necessarily occur at the same time. Statistically, the 95th percentile travel time of the whole corridor should be less than or, at most, equal to the sum of each segment's 95th percentile travel time. While the segment planning time index gives detailed information about each road segment's reliability performance, travelers may be more interested in route or corridor specific reliability. Future CMP analysis will look into this.

²⁵ Georgia Regional Transportation Authority, *2008 Transportation Metropolitan Atlanta Performance Report*,
http://www.grta.org/PDF_Files/2008_Transportation_MAP_Report.pdf

Figure 26: Sample Map of Planning Time Index - Workday AM Peak 6:00-10:00 AM (2009) for the I-95 Corridor Coalition Covered Highways

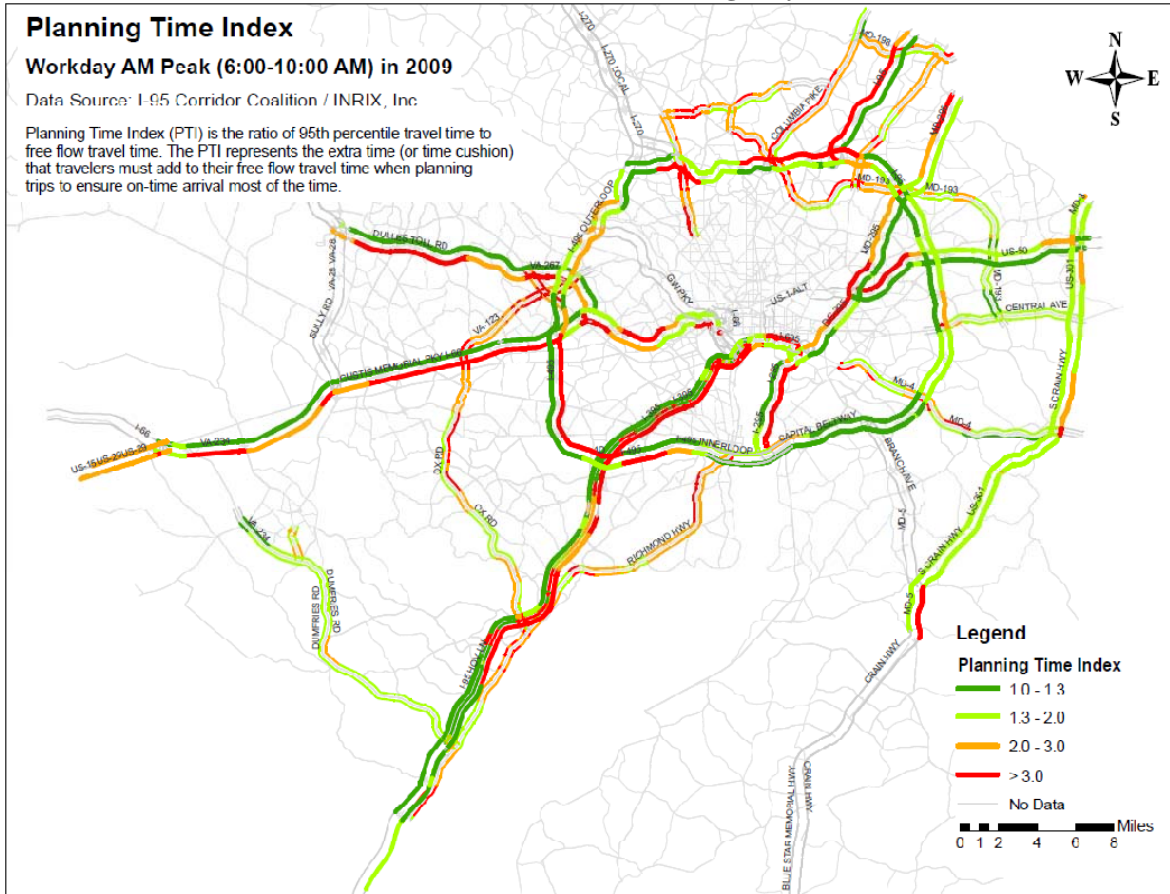

Month-to-Month Planning Time Index

Figure 27 shows the month-to-month planning time index variations of AM and PM peak periods and all day for the 12 months in 2009 and the last 6 months in 2008.

The month-to-month variation of planning time index generally follows the trend of travel time index variation. Similar to what was found in travel time index, each month in the second half of 2009, especially December, experienced much higher planning time index compared to the last six months of 2008 on the freeways covered by the I-95 Corridor Coalition. The December 19, 2009 winter storm also played a significant role for the large difference between December 2008 and 2009 planning time index values.

Figure 27: Planning Time Index by Month for the I-95 Corridor Coalition Covered Freeways

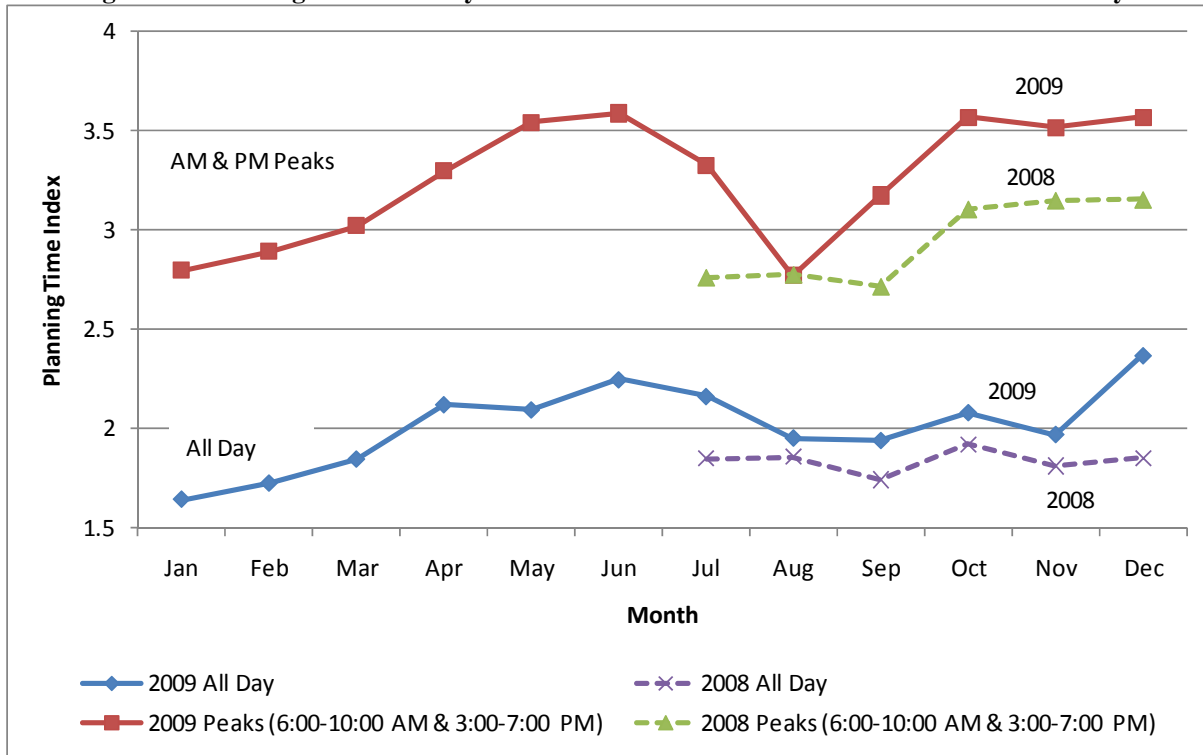

Time of Day and Day of Week Planning Time Index

Figure 28 presents planning time index by time of day (hour) and day of week for all the I-95 Corridor Coalition Vehicle Probe Project covered freeways within TPB member jurisdiction in 2009 (note “7a” in the figure refers to the 7:00-8:00 AM hour, and “7p” refers to the 7:00-8:00 PM hour, etc.). Some noteworthy findings include:

- Tuesday morning and Friday afternoon were the most unreliable AM and PM peak periods;
- Friday 5:00-6:00 PM remained the most unreliable hour of the week, with a planning time index of 4.0; This is one hour later than the peak congestion hour 4:00-5:00 PM on Friday;
- Tuesday 8:00-9:00 AM remained the most unreliable morning rush hour, with a planning time index of 3.11;
- For the same workday, the morning peak hour was less unreliable than the evening peak hour;
- Saturday travel time was generally more reliable than Sunday, and both weekend days were generally more reliable than workdays, especially during peak periods.

**Figure 28: Planning Time Index by Time of Day and Day of Week (2009)
 for the I-95 Corridor Coalition Covered Freeways**

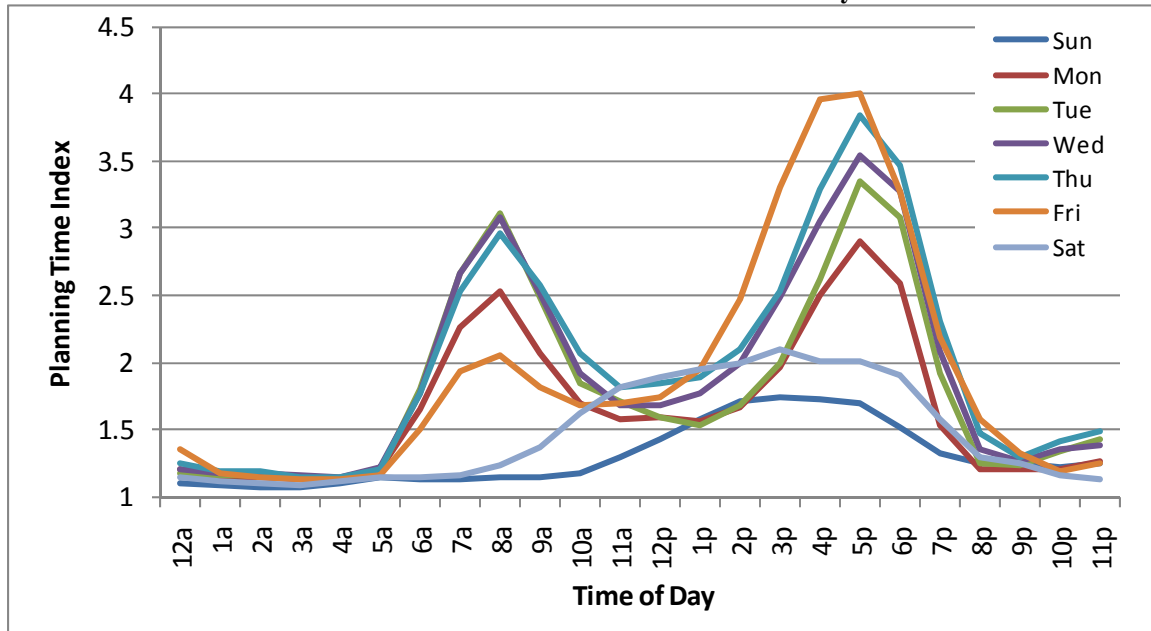

2.1.3.5 Buffer Time Index

Buffer time index is another measure of travel time reliability. It is the ratio of 95th percentile travel time over average travel time (not free flow travel time used in the planning time index) and expresses the extra time (or time cushion) that a traveler should budget in addition to the average average travel time to arrive on time 95 percent of the time.

For travelers who are familiar with everyday congestion (e.g. commuters), buffer time index would be a preferred travel time reliability measure since it is based on average travel time; for those who are not familiar with that, planning time index may be preferred as it is based on free flow travel time.

Maps of Planning Time Index

Planning time index of each road segment (TMC) for the 13 different time periods (used for maps of travel time index and planning time index) in 2009 is visualized on the regional map, which can be found in [Appendix E](#). An example of the maps is shown below for non-holiday workday morning peak period, 6:00 – 10:00 AM ([Figure 29](#)).

As expected, the spatiotemporal distribution of buffer time index has significant differences from travel time index and planning time index²⁶. Some segments usually congested had lower buffer

²⁶ Readers should be cautious again in interpreting the segment (TMC) – based buffer time index calculated in this report. Corridor or route buffer time is NOT simply the sum of segment buffer time. The former should be less or, at most (rarely), equal to the sum of the latter. The same rationale and statistic theory hold: the worst condition of each segment on the corridor does not necessarily occur at the same time, and the 95th percentile travel time of the whole

time index compared to other segments usually less congested. Some examples include: I-66 EB approaching the Beltway, I-66 EB adjacent VA-234 and the Beltway in general.

The highest buffer time indices do not necessarily equate to the locations with the highest levels of congestion – rather, they equate to the locations with the highest variability/unreliability. Segments that are “reliably bad” can have low buffer time indices.

Figure 29: Sample Map of Buffer Time Index - Workday AM Peak 6:00-10:00 AM (2009) for the I-95 Corridor Coalition Covered Highways

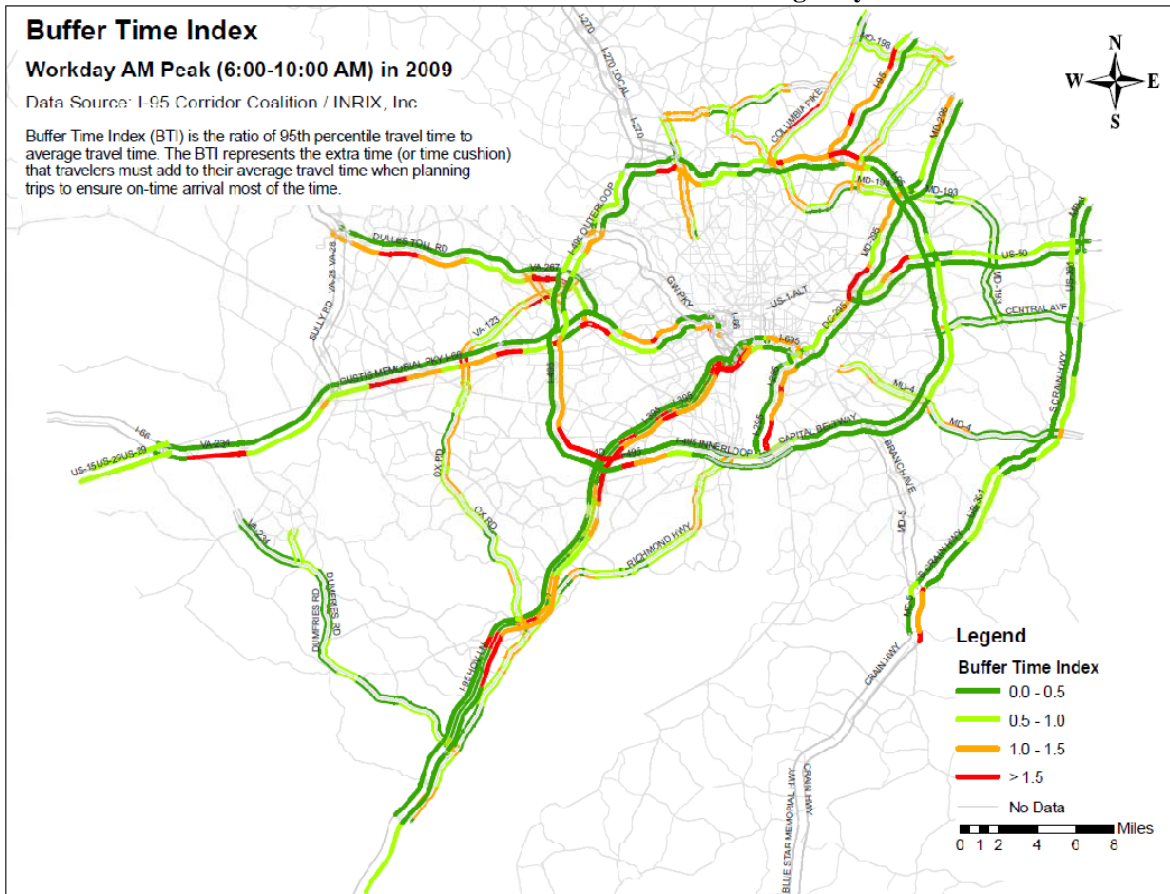

Month-to-Month Buffer Time Index

Figure 30 shows the month-to-month buffer time index variations of AM and PM peak periods and all day for the 12 months in 2009 and the last 6 months in 2008.

The month-to-month variation of buffer time index generally follows the trend of travel time index variation. Similar to what was found in travel time index, each month in the second half of 2009, especially December, experienced much higher planning time index compared to the last six months of 2008 on the freeways covered by the I-95 Corridor Coalition. The December 19,

corridor should be less than or, at most, equal to the sum of each segment’s 95th percentile travel time. Future CMP analysis will look into corridor or route buffer time index.

2009 winter storm also played a significant role for the large difference between December 2008 and 2009 planning time index values.

Figure 30: Buffer Time Index by Month for the I-95 Corridor Coalition Covered Freeways

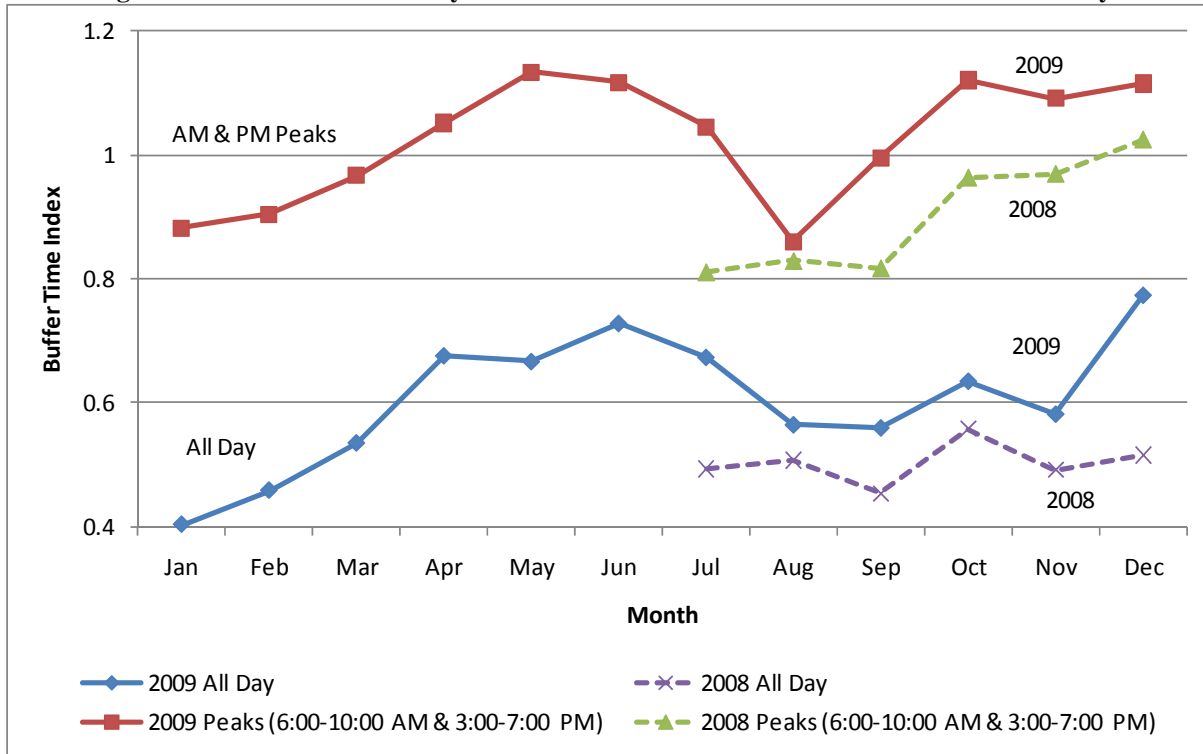

Time of Day and Day of Week Buffer Time Index

Figure 31 presents buffer time index by time of day (hour) and day of week for all the I-95 Corridor Coalition Vehicle Probe Project covered freeways within TPB member jurisdiction in 2009 (note “7a” in the figure refers to the 7:00-8:00 AM hour, and “7p” refers to the 7:00-8:00 PM hour, etc.). Some noteworthy findings include:

- Tuesday morning and Friday afternoon were the most unreliable AM and PM peak periods;
- Friday 5:00-6:00 PM remained the most unreliable hour of the week, with a buffer time index of 0.90; This is one hour later than the peak congestion hour 4:00-5:00 PM on Friday;
- Tuesday 8:00-9:00 AM remained the most unreliable morning rush hour, with a buffer time index of 0.70;
- For the same workday, the morning peak hour was less unreliable than the evening peak hour;
- Saturday travel time was generally more reliable than Sunday, and both weekend days were generally more reliable than workdays, especially during peak periods.

**Figure 31: Buffer Time Index by Time of Day and Day of Week (2009)
 for the I-95 Corridor Coalition Covered Freeways**

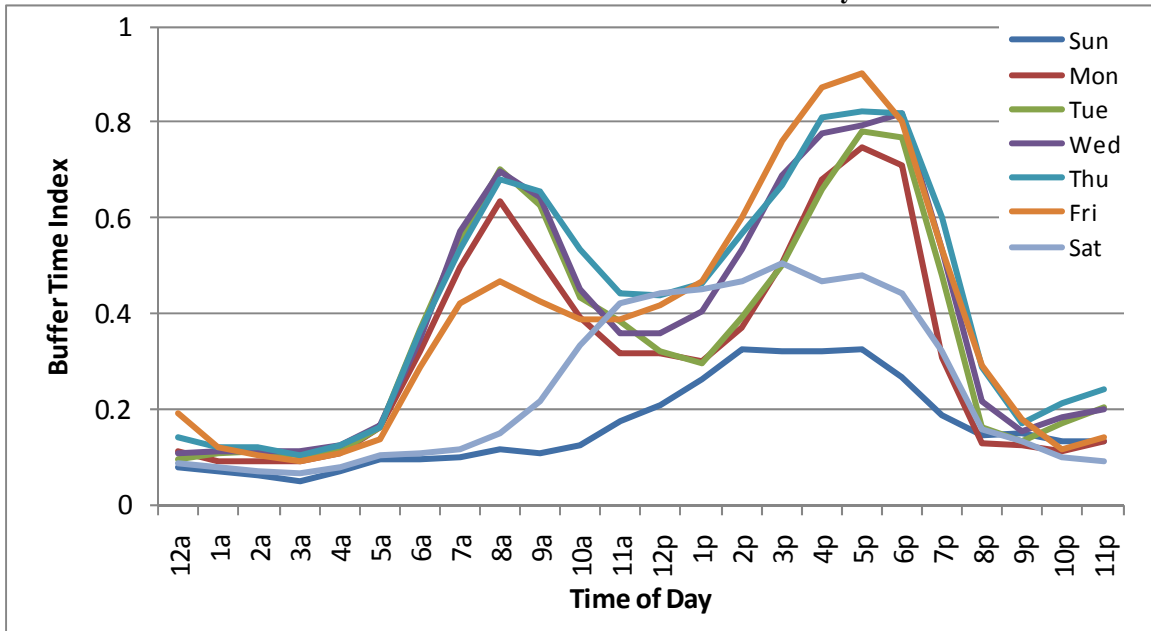

2.1.3.6 Top 25 Bottlenecks

Based on travel time index and the number of congested hours, the I-95 Corridor Coalition/INRIX data also identified the top 25 most congested bottlenecks for the INRIX data covered freeways in the region, which are listed in Table 4. Seven of the 25 top bottlenecks are already listed by the Skycomp survey, and the rest of 18 bottlenecks are provided in Table 3 in Section 2.1.1 and merit further investigation for improvements.

Table 4: Top 25 Most Congested Location for the INRIX Data Covered Freeways in the Region

Rank	Road/Direction	Segment/Interchange	Length (miles)	Hours of Congestion in A Week	Average Speed when Congested (mph)
1	I-95 HOV SB	VA-234/DUMFRIES RD/EXIT 152 -- I-95 MERGE	0.68	31	18
2	I-495 IL	MD-187/OLD GEORGETOWN RD/EXIT36 -- MD-185/CONNECTICUT AVE/E	3.37	30	16
3	I-95 SB	VA-234/DUMFRIES RD/EXIT 152	0.63	32	20
4	I-95 NB	VA 3000/PR WM PKWY/EXIT 158 -- VA-642/LORTON RD/EXIT 163	5.49	35	22
5	I-66 WB	VA-234/PR WM PKWY/EXIT 44	0.41	27	17
6	MD-295 NB	I-495/BELTWAY -- POWDER MILL RD	4.18	30	21
7	I-95/I-395 SB	I-495/BELTWAY -- VA-7100/FAIRFAX COUNTY PKWY/EXIT 166	5.29	28	20
8	I-95 SB	US-1/RICHMOND HWY/EXIT 161 -- VA-123/GORDON BLVD/EXIT 160	1.60	32	23
9	I-66 EB	VA-7/LEESBURG PIKE/EXIT 66 -- 25TH ST	2.16	29	20
10	I-495 OL	MD-650/NEW HAMPSHIRE AVE/EXIT28 -- US-29/COLESVILLE RD/EXIT 30	2.75	25	18
11	I-95 SB	VA-619/JOPLIN RD/EXIT 150	1.90	27	21
12	I-66 EB	VA-243/NUTLEY ST/EXIT 62 -- I-495/BELTWAY/EXIT 64	3.11	22	17
13	I-395 NB	VA-110/EXIT 9 -- US-1 EXIT	1.17	27	17
14	I-395 HOV NB	EADS ST -- END OF MEMORIAL BRIDGE	1.58	27	20
15	I-495 IL	US-50/ARLINGTON BLVD/EXIT 50	0.67	26	22
16	I-495 IL	VA-267/EXIT 45	0.51	20	17
17	I-395 SB	6TH ST -- 12TH ST/MAINE AVE	0.32	22	15
18	I-66 WB	VADEN DR/EXIT 62	0.67	24	22
19	VA-267 EB	I-66	1.94	20	18
20	I-95 SB	DALE BLVD/SMOKETOWN RD/EB EXIT 156	1.99	18	18
21	I-495 IL	VA-193/GEORGETOWN PIKE/EXIT 44 -- CLARA BARTON PKWY/EXIT 41	2.64	20	20
22	I-495 OL	VA-123/CHAIN BRIDGE RD/EXIT 11	0.70	20	19
23	I-395/I-95 NB	I-495 BELTWAY	1.63	17	16
24	I-495 IL	CABIN JOHN PKWY -- MD-190/RIVER RD/EXIT 39	0.46	16	16
25	I-95 HOV NB	VA-7900/FANCONIA SPRINGFIELD PKWY/EXIT 169	0.44	20	23

2.2 Safety and Congestion

2.2.1 OVERVIEW

Transportation safety is a serious concern in the Washington region. There is shown to be a strong correlation between traffic safety and traffic congestion. Incidents, including those in work zones, secondary incidents, involve adverse weather events, or bicycle and pedestrian incidents, all can contribute to non-recurring congestion. Sources indicate that approximately half of all congestion is caused by non-recurring congestion.²⁷ Raising awareness about such things as transportation safety can help address an issue at the root of incident management.

Engineering and operational management activities can help improve safety and therefore lessen the impact of crashes and other safety problems on congestion. Many transportation agencies in the region have active incident management programs that quickly respond to incidents, help reduce their duration, and lessen the likelihood of secondary accidents in traffic backups. These programs are further integrated into the Metropolitan Area Transportation Operations Coordination (MATOC) program, to undertake day-to-day, real-time multi-agency coordination

²⁷ Describing the Congestion Problem, Federal Highway Administration:
http://www.fhwa.dot.gov/congestion/describing_problem.htm.

and information sharing regarding transportation systems conditions during major incidents in the Washington region. Furthermore, transportation agencies look for ways to improve the safety of the physical roadway infrastructure, again to improve safety and therefore lessening its impacts on congestion. Such engineering improvements may include turn lanes, improvements of site lines, lighting, guardrails, and pedestrian enhancements.

The TPB is addressing transportation safety through a variety of programs and activities:

- Transportation safety is encouraged and tracked by TPB member agencies through the ***Transportation Improvement Program (TIP)***, which provides information on projects to be completed over the next six years. The TIP contains projects whose primary purpose is to enhance safety, and explains how other projects will support transportation safety.
- The ***TPB's transportation safety planning activities*** helps facilitate regional traffic data compilation, sharing this data among member agencies, and identifying regional safety problems.
- The ***Transportation Safety Subcommittee*** is a newly-formed subcommittee of the TPB Technical Committee. The Subcommittee will focus on advising staff on the federally-required transportation safety portion of the long-range transportation plan. The diversity of the Subcommittee, which is comprised of stakeholders from the State Departments of Transportation Planning, planning staff of the TPB member agencies, law enforcement officials, and public health representatives, will be essential to providing a wide-range of safety perspectives. Another key objective of the Subcommittee will be exchanging information on ongoing safety activities and best practices.
- The ***Street Smart Pedestrian and Bicycle Safety*** campaign is an annual region-wide campaign to raise public awareness on pedestrian and bicycle safety.²⁸ The campaign, created by the TPB's Bicycle and Pedestrian Subcommittee in 2002, uses methods such as radio, newspaper, and transit advertising, public awareness efforts, and law enforcement with an overall goal of changing motorist and pedestrian behavior and reducing pedestrian and bicycle deaths and injuries.

Transportation Safety remains a key focus of transportation planning in the region. The TPB's transportation safety work program acts as a home for facilitating discussion of transportation safety issues in our region, and raising awareness about those issues. Continuing safety planning activities in the Washington region will continue to be important to the CMP.

2.2.2 TRAFFIC SAFETY FACTS

The TPB Transportation Safety Subcommittee compiles, summarizes, and reports safety and other information about the region's transportation system. Some of these traffic safety facts observed from 2003 to 2007 may help in illustrating the relationship of safety and congestion.²⁹

- Traffic deaths per 100,000 population in the Washington region had slowly gone down from 2005 to 2007, reaching 8.10 in 2007, the lowest level since 2003;

²⁸ <http://www.beststreetsmart.net/>

²⁹ The Regional Transportation Safety Picture, presentation to the Transportation Safety Subcommittee meeting, 2009-06-18: <http://www.mwcog.org/uploads/committee-documents/1F5bXV9b20090618104417.pdf>.

- Traffic injuries per 100,000 population had declined a little faster than the death rate since 2003, reach its lowest level of 821 in 2007;
- Both total crashes and crashes per 100,000 population had gradually gone down since 2003, reach their lowest levels of 82,054 and 1,678 respectively in 2007;
- In terms of jurisdictional average annual traffic deaths per 100,000 population, suburban Maryland had the highest rate (10.7) from 2005 to 2007, followed by District of Columbia (8.0) and Northern Virginia (6.1);
- In terms of jurisdictional average annual traffic injuries per 100,000 population, District of Columbia had the highest rate (1,213) from 2005 to 2007, followed by suburban Maryland (875) and Northern Virginia (820);
- In terms of jurisdictional average annual crashes per 100,000 population, District of Columbia had the highest rate (8,421) from 2003 to 2007, followed by Northern Virginia (5,255) and suburban Maryland (4,740);
- Crashes involved young drivers (age < 21) and occurred at signalized intersections stood out as traffic safety issues according to 2007 crash data.

The above facts reveal that traffic safety is something that needs to be taken very seriously. The incident-related and non-recurring strategies our region undertakes not only manage congestion that commonly occurs after an incident happens, but these strategies can also prevent subsequent incidents from occurring. Our region's strategies aim at improving safety on our roadways, and ultimately contribute to making a nationwide difference.

2.2.3 INCIDENT-RELATED AND NON-RECURRING CONGESTION

Fifty percent of congestion is said to be non-recurring, which is congestion due to incidents such as crashes, disabled vehicles and special events, work zones and bad weather.³⁰ On average, there were more than 200 traffic related incidents on the region's roadways every day, the most severe of which can disrupt traffic for hours, cause secondary incidents, and overall cause major disruptions to the transportation system. Heavily-trafficked areas and construction areas are especially prone to incidents. Nonrecurring events dramatically reduce the available capacity and reliability of the entire transportation system. Travelers and shippers are especially sensitive to the unanticipated disruptions to tightly scheduled personal activities and manufacturing distribution procedures.

The Federal Highway Administration breaks down non-recurring congestion into three primary causes: 1) incidents ranging from a flat tire to an overturned hazardous material truck (25%), work zones (10%), and weather (15%).

A number of TPB's member agencies, including DDOT, MDOT, VDOT, and some local jurisdictions operate incident-management programs. These programs are further coordinated and facilitated by the Metropolitan Area Transportation Operations Coordination (MATOC) program, which has more emphasis on regional-significant incidents. The MATOC program and the local jurisdictional programs help minimize the impact the events have on the transportation network and traveler safety. If an incident disrupts traffic, it is important for congestion that

³⁰ Describing the Congestion Problem, Federal Highway Administration:
http://www.fhwa.dot.gov/congestion/describing_problem.htm.

normal flow resumes quickly. The TPB compiles and analyzes data associated with these incident management programs (see [Section 3.3.3.1](#)).

2.3 Congestion on the Metropolitan Area's Transit Systems

2.3.1 IMPACTS OF HIGHWAY CONGESTION ON TRANSIT SYSTEMS

Often the region's highway congestion will have an impact on transit systems, such as rail and bus. To some extent, transit operations are concentrated in areas of high-density land uses, where traffic congestion may be expected. Bus schedules generally are designed to anticipate and accommodate highway congestion whenever possible. However, there are instances when congestion is unpredictable and can not only impact the timing of one bus, but of the entire bus system and other transit systems the bus connects to (such as commuter rail).

One way to analyze the performance of one mode's impact on another is to identify key linkages between one or more modes of transportation. In 2008 the TPB conducted a Regional Bus Survey throughout our region. This survey found about 23% of the region's bus passengers accessed bus system via buses or autos and about 67% of all passengers had one or more transfers to reach their final destinations³¹. These passengers were subjected to the impact of highway congestion if it occurs on pertinent routes.

2.3.2 CONGESTION WITHIN TRANSIT FACILITIES OR SYSTEMS

Congestion can also be an issue within transit. If the demand for rail and buses is high and the capacity cannot keep up with that demand, then transit becomes too crowded. Just as incidents can cause non-recurring incidents on roadways, the same can occur on transit facilities. Even a minor bus or train incident can cause back-ups and delays.

In addition, certain transit facilities may experience more congestion than others. Union Station in the District of Columbia is a station that accommodates Metrorail, Metrobus, DC Circulator buses, Maryland Area Rail Commuter (MARC) trains, Virginia Railway Express (VRE) trains, and AMTRAK. With these various transit options, Union Station has become a primary connection point for commuters, and visitors.

Congestion can not only result on the transit system itself, but on station platforms and around the station. In 2008, WMATA released their findings of the Metrorail Station Access & Capacity Study³². This study found that a number of stations need to expand their capacity in order to satisfy the demand imposed by existing large ridership and/or future ridership increases, as listed in [Table 5](#).

³¹ 2008 Regional Bus Survey, Final Technical Report, <http://www.mwcog.org/uploads/committee-documents/a15aXldb20091029142551.pdf>.

³² Metrorail Station Access & Capacity Study, Washington Metropolitan Area Transit Authority (WMATA), <http://www.wmata.com/pdfs/planning/Final%20Report%20Station%20Access%20&%20Capacity%20Study%202008%20Apr.pdf>.

In 2007, an analysis was conducted by TranSystems to gauge the effect traffic congestion and passenger crowding has on WMATA bus operations.³³ The analysis found evidence that traffic congestion imposes a cost on WMATA, as the peak vehicle requirement needs to be increased to maintain a sufficient level of service on certain routes. In addition, growth in passenger demand has the same effect, since additional bus trips need to be added to certain routes to avoid overcrowding.

Table 5: Existing and Future Station Capacity Issues

Station	Mezz	Vertical		Faregate	
		2005	2030	2005	2030
Archives-Navy Memorial-Penn Quarter		○	○		
Bethesda			○		
Branch Ave		○	○		
Cleveland Park					○
Court House			○		○
Farragut North	SE	⊗	⊗		
Farragut West	W	○	○		
Foggy Bottom-GWU		○	○		
Franconia-Springfield			○		
Gallery Pl-Chinatown	N	○	⊗	○	⊗
	W				○
Judiciary Square	E		○		
L'Enfant Plaza	E	○	⊗		
	W		⊗		
Metro Center	N	○	⊗		○
	S	⊗	⊗		
	W		○		
Navy Yard*	E				○
Shady Grove		○	⊗		
Takoma				○	○
Twinbrook					○
White Flint					○
Union Station	S	○	○		
	W	○	○		

Legend

- Needs study ($0.5 \leq v/c < 0.75$)
- ⊗ Needs improvement ($v/c \geq 0.75$)

**Note: Both Navy Yard mezzanines will have unique future needs, which may not be reflected in this analysis, due to the opening of the Washington Nationals Ballpark in 2008.*

Source: WMATA, 2008, Metrorail Station Access & Capacity Study.

The Congestion Management Process (CMP) recognizes the growing concern of congestion within our regional transit systems. As more and more people are living in the outer suburbs and working far from their home, more commuters are looking to transit options instead of driving. While increase in transit use is overall a positive trend, it is important that the concern of transit congestion throughout the region be examined further.

³³ Memo: Impact of Congestion on Metrobus Operations. March 12, 2007.
<http://www.mwcog.org/uploads/committee-documents/t1daVI020070509095750.pdf>

2.4 Park-and-Ride Facilities

The Washington region has over 300 park-and-ride lots where commuters can conveniently join up with carpools, vanpools, or connect to public transit. Many of these lots are conveniently located for those that commute from the outer suburbs of Virginia or Maryland.

The following statistics provide an idea of why park-and-ride lots play such a popular role in the region's transportation system³⁴:

- About one third of Park & Ride Lots have commuter bus service available.
- Approximately one third of the Park & Ride Lots have rail service available, including Metro, MARC, VRE and Baltimore Light Rail.
- Parking is free at 90% of the Park & Ride Lots.
- About 25% of the Park & Ride Lots have bicycle parking facilities.

In addition to the above statistics, Intelligent Transportation Systems (ITS) strategies such as traveler information systems and electronic payment systems can add to the convenience of park-and-ride lots. Commuter Connections also displays a park-and-ride map on their website, which provides users with the location of lots, transit stations in the vicinity, and the location of telework centers.

Due to the popularity of park-and-ride lots, some are experiencing overcrowding, where demand exceeds supply. This tends to happen at lots at or near Metrorail and commuter rail service. Over the past several years, Maryland State Highway Administration (SHA) has taken inventory of the SHA owned and maintained ridesharing facilities in the state (**Appendix F**). Inventory was taken in Spring 2001, and again in 2005, 2006, and 2007. Average use has been gradually increasing over the years, with approximately 51% in 2001, 55% in 2005, and 57% in 2006 and 2007. SHA notes that once their park-and-ride lots fill to 80 percent capacity, locations for new lots are considered.

The most recent TPB study on the usage of park-and-ride lots was conducted in 1996. As the region continues to grow and the demand for park-and-ride lots increases, this is an area that may need to be examined more closely.

According to the recent WMATA Metrorail Station Access & Capacity Study (April 2008), Metro presently owns and operates 58,186 parking spaces. On an average weekday, almost all of those spaces are occupied. Only a handful of stations—White Flint, Wheaton, College Park-U of MD, Prince George's Plaza, and Minnesota Ave—have a substantial amount of available capacity. **Table 6** shows parking lot utilization as of October 2006.

³⁴ Source: Commuter Connections <http://www.mwcog.org/commuter2/commuter/ridesharing/prlocations.html>

Table 6: Metro Parking Lot Utilization, October 2006

Station and Region	Lot Capacity	Average Utilization ¹²	
		Mon-Thurs	Fri
<u>MONTGOMERY COUNTY</u>			
Grosvenor	1,894	103%	92%
White Flint	1,158	41%	31%
Twinbrook	1,097	84%	70%
Rockville	524	104%	101%
Shady Grove	5,467	83%	78%
Glenmont	1,781	103%	102%
Wheaton	977	63%	40%
Forest Glen	596	101%	96%
<u>PRINCE GEORGE'S COUNTY</u>			
New Carrollton	3,519	98%	88%
Landover	1,866	76%	49%
Cheverly	530	97%	84%
Addison Road-Seat Pleasant	1,268	91%	71%
Capitol Heights	372	88%	82%
Greenbelt	3,399	99%	85%
College Park-U of MD	1,870	68%	64%
Prince George's Plaza	1,068	67%	60%
West Hyattsville	453	101%	102%
Southern Ave	1,980	98%	89%
Naylor Road	368	110%	107%
Suitland	1,890	100%	91%
Branch Ave	3,072	108%	106%
Morgan Boulevard	635	95%	87%
Largo Town Center	2,200	97%	87%
<u>DISTRICT OF COLUMBIA</u>			
Deanwood	194	95%	82%
Minnesota Ave.	333	52%	44%
Rhode Island Ave.	340	95%	94%
Fort Totten	408	88%	86%
Anacostia	808	89%	71%
<u>NORTHERN VIRGINIA</u>			
Huntington	3,090	99%	93%
West Falls Church-VT/UVA	2,009	103%	89%
Dunn Loring-Merrifield	1,319	107%	105%
Vienna/Fairfax-GMU	5,849	100%	91%
Franconia-Springfield	5,069	96%	88%
Van Dorn Street	361	110%	118%
East Falls Church	422	117%	129%
System Total	58,186	94%	85%

Source: WMATA

2.5 Airport Access

The transportation linkage between airports and local activities is a critical component of the transportation system. The Washington region has two major airports – Ronald Reagan Washington National Airport (DCA) in Arlington, VA, and Washington Dulles International Airport (IAD) in Loudoun County, VA. The region is also served by the nearby Baltimore/Washington International Thurgood Marshall Airport (BWI). The majority (94%) of those traveling to the region’s airports does so via the highway network (i.e. personal cars, rental cars, taxis, buses)³⁵. Therefore, understanding ground airport access is important to congestion management for two primary reasons:

- Choice of airport to use and even the decision to fly in general can be based on the quality, cost, and travel time associated with the ground journey to the airport. Traffic conditions can have an impact on these decisions.
- Understanding airport ground access provides a basis for understanding overall congestion on major roadways at peak travel times.
 - Studying airport ground access can provide information on traffic patterns that may have not otherwise been considered, in particular the relationship between travel times and distances. For example, a study can examine and compare trips across the region (e.g. from Maryland to IAD), or shorter trips where the origin and destination are close together.
 - Passengers using the airports may be non-residents of the Washington region, so this airport access information can give us information on trips originating elsewhere.

Conclusions of the most recent TPB study on airport ground access travel time³⁶ provide relevant information to congestion management:

- Overall, during the AM and PM peak periods there was a much higher percentage of roadway segments at LOS “D” or lower than the mid-day peak period. Furthermore, roadways with LOS “A” or “B” almost doubled in the mid-day period. This reflects the common pattern morning and evening commute congestion found when surveying freeways and arterials.
- Travel time from activity centers in the inner and outer suburbs to DCA during the AM and PM is important to congestion management studies, as it is similar to flow of commuters traveling to and from the inner core for employment. It was found in the 2003 study that generally travel times are increasing and LOS is decreasing from major activity centers to DCA in the AM.
 - From Tyson’s Corner to DCA during the AM peak period, travel time almost doubled when compared to the previous 1995 study.
 - From Rockville to DCA in the AM travel time increased by nearly 50%.

³⁵ 2007 Washington-Baltimore Regional Air Passenger Survey – Final Report, September 2008.

<http://www.mwcog.org/uploads/committee-documents/IF5dXlhf20081003124339.pdf>

³⁶ Washington – Baltimore Regional Airport 2003 Ground Access Travel Time Study Update, September 2004.

<http://www.mwcog.org/uploads/committee-documents/tFlcVIY20060622150454.pdf>

- From downtown Washington, DC to DCA travel time increased only slightly, but LOS decreased, with levels “E” and “F” experienced along K Street, 4th Street, and George Washington Parkway.
- By the same token, travel times from some activity centers to IAD in the PM can provide an illustration of traffic conditions during the evening commuting period. Overall, when comparing the 2003 ground access travel time data to that of 1995, it seems that travel time is increasing slightly, but not as dramatically as was seen in the AM peak periods.

2.6 Freight Movement and Congestion

In addition to surface transportation congestion around airports and congestion's impacts on person movement, congestion in and around major metropolitan regions such as Washington has significant impacts on freight movements. Though freight movements by rail, water, and pipeline are not impacted as much as trucks are by surface transportation congestion, rail freight companies also face bottlenecks and congestion challenges in the Washington region.

Traffic congestion on the region's highways and arterials increasingly slows truck freight deliveries and impacts both shippers and consumers. Shippers are already adjusting their operations to beat congestion. Some impacts of increased congestion to the truck freight industry are:

- Shippers have less flexibility in scheduling when to deliver their shipments;
- Shippers may decide to make fewer deliveries;
- Increased costs in time and fuel result in increased costs to shippers which are passed on to consumers, and ultimately impact the economy
- Truck drivers face longer and more grueling hours for a given trip;
- Businesses (and the jobs they provide) may choose to locate in other less-congested metropolitan areas, in part because of freight movement delays.

In 2007, a freight study was conducted on behalf of the Transportation Planning Board and the region by a team of expert consultants. According to the study, approximately 222 million tons of goods worth over \$200 billion are transported to, from, or within the Washington region annually.³⁷ Approximately three-quarters of this freight movement (by weight) is by truck. An additional 314 million tons of goods were estimated pass through the region annually (through traffic). Therefore, freight movement in the Washington region is significant across the major modes (by both truck and rail) as well as both local freight movement and through movement. It is therefore critical for freight movement to have an efficient surface transportation network to move traffic in, about, and through the region.

Professional and business services (21%), trade and transportation (14%), federal (11%), and state and local government (10%) dominate the employment industries in the Washington region. These industries do not produce many consumer goods; therefore the National Capital Region is

³⁷ . *Enhancing Consideration of Freight in Regional Transportation Planning*, Cambridge Systematics, Inc., May 2007, p2-1 (GWI Analysis of Bureau of Labor Statistics and Maryland Department of Labor, Licensing, and Regulation 2005, data). <http://www.mwcog.org/uploads/committee-documents/bF5fW1pX20080222142629.pdf>

highly dependent on truck deliveries into the region, much coming from outside the region. This demand puts pressure on the regional surface transportation system as trucks maneuver the highway and arterial transportation network to make their deliveries on time. In order to make just-in-time deliveries, shippers need a moving transportation network that they can depend upon.

Future trends predict a significant growth in freight for all transportation modes. Since freight trucks operate on a much more expansive transportation network than rail, they are more flexible shippers and will continue to experience growth. By 2030 rail tonnage is projected to grow by 50% while the forecast truck tonnage growth rate is 106%. According to the national Freight Analysis Framework (FAF), the Washington metropolitan region is projected to see the amount of total tonnage moving to, from, and within the region to increase by 110% in 2030 and the growth in value to increase by 145%.³⁸ These rates are higher than those projected for the country as a whole.

The Panama Canal Expansion is anticipated to be complete in 2014. This expansion will allow larger container ships to access ports on the East Coast and the East Coast ports are gearing up in anticipation of the larger ships. This expansion will impact the freight movements on the East Coast and the Washington region is expected to carry more freight in the future over its highway and rail transportation systems.

COG/TPB has recently established a Freight Program with a Freight Subcommittee as a major component of this program. The Freight Subcommittee provides a structured voice for freight issues and concerns within the Metropolitan Washington Region. This forum gives freight stakeholders the opportunity to share freight concerns and information with the TPB and decision-makers. Activities of the Freight Subcommittee include regular meetings with special guest speakers, sites visits, and information sharing. An *Integrated Freight Report*³⁹ was recently released to enhance the integration of regional freight planning and the CLRP. Staff is also developing the National Capital Region Freight Plan, which will be published soon.

Through the Freight Program, COG/TPB also supports efforts to share information and identify solutions for multi-regional issues such as congestion, such as the I-95 Corridor Coalition's Mid-Atlantic Truck Operations study (MATOps) whose objective is to identify truck bottlenecks in the Mid-Atlantic region and assess the cost of delay, and the similar Mid-Atlantic Rail Operations study (MAROps), a study focused on improving rail movement along the I-95 corridor.

Trucks have impacts on congestion, competing for street and roadway space in congested corridors. Similarly, competition for space along streets in urban environments for goods delivery by truck is also a challenge. Discussions with freight movement stakeholders have revealed that they are already going to great lengths to conduct freight movement at off-peak hours, or to move goods by rail or pipeline to the extent possible and economically feasible. Full consideration of non-highway means of freight movement needs to be continued. However, the

³⁸ Ibid., May 2007, p2-30 (2002 FAF data).

³⁹ *Integrated Freight Report*, July 15, 2009. <http://www.mwcog.org/uploads/committee-documents/b15aX11Z20091020141036.pdf>

projected robust growth in all modes of freight movement in the future will mean that trucks will remain a major presence on the region's roadways.

The I-95 Corridor Coalition's MATOps study identified the following five worst truck bottlenecks in the region based on observed delay in 2006⁴⁰:

- 1) I-95 at VA-7100, Virginia
- 2) I-95 at VA-234, Virginia
- 3) I-95 at I-495, Maryland
- 4) I-495 at American Legion Bridge, Virginia
- 5) I-495 at I-66, Virginia

The # 3) bottleneck, I-95 at I-495 in Maryland, was also identified as the 25th worst freight bottleneck in the nation's selected 30 freight bottlenecks⁴¹. This study was conducted by the American Transportation Research Institute (ATRI) and the 30 bottlenecks were chosen by the Federal Highway Administration Office of Freight.

Several of these bottlenecks are also revealed in Virginia and Maryland Departments of Transportation traffic count data (Maryland 2008 data and Virginia 2007 data). **Figure 32** shows truck percentages of total Annual Average Daily Traffic (AADT) on the region's freeway network⁴². The percentages are truck counts averaged from both directions. The congestion on the freeways is for the morning peak period conditions from the spring 2008 TPB aerial survey.

⁴⁰ I-95 Corridor Coalition, *Mid-Atlantic Truck Operations study – Final Report*. Cambridge Systematics, Inc. October 2009. http://www.i95coalition.net/i95/Portals/0/Public_Files/pm/reports/DFR1_MATOps_Truck%20Operations%20V3.pdf

⁴¹ American Transportation Research Institute. *Freight Performance Measures Analysis of 30 Freight Bottlenecks*. March 2009.

⁴² *Integrated Freight Report*, July 2009. <http://www.mwcog.org/uploads/committee-documents/kV5aX11a20091020140842.pdf>

Figure 32: Percentages of Truck Counts on the Region’s Morning Peak Period Network

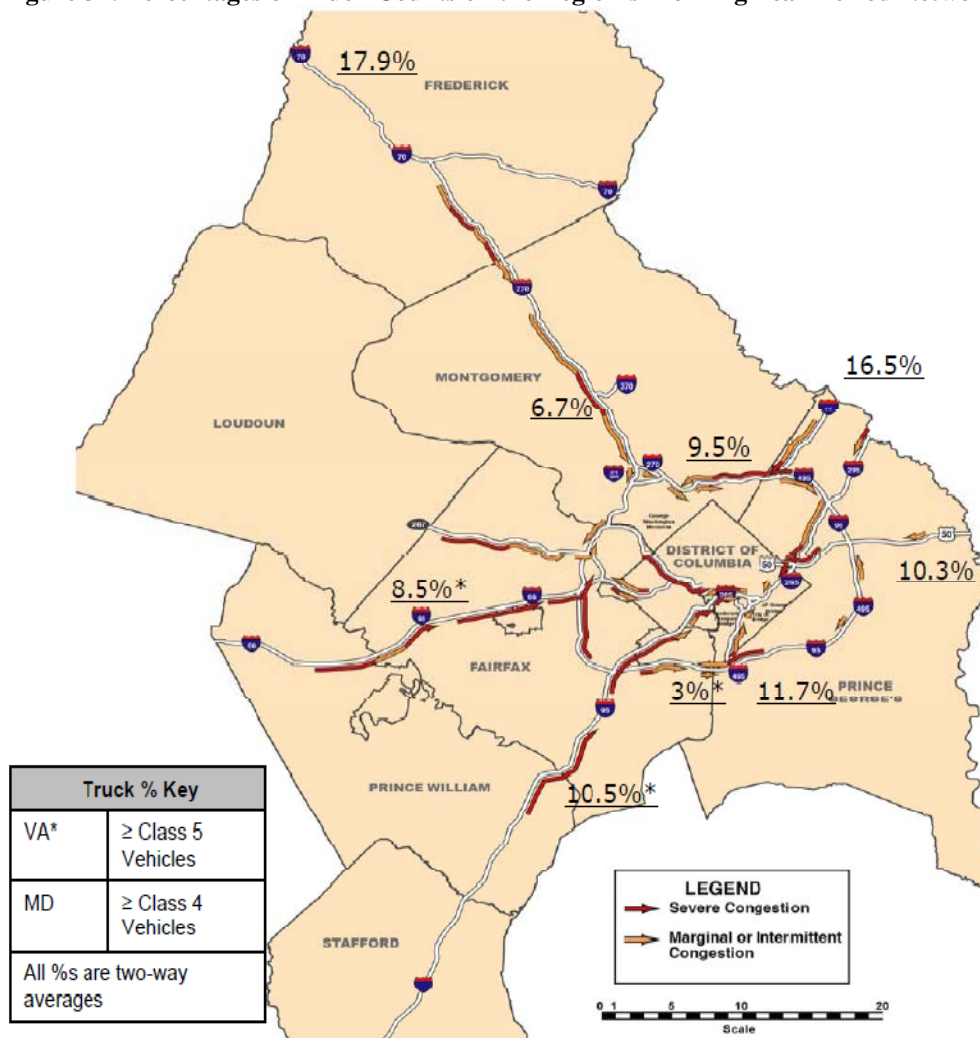

2.7 Other Congestion Monitoring and Data Consolidation Activities

In addition to the congestion monitoring activities presented above in this chapter, the following monitoring and data consolidation activities are also carried out in the Washington region.

2.7.1 CORDON COUNTS

The cordon count program originated from the desire to assess the impact of the construction of the region’s Metrorail system starting in the late 1960’s. Thus, a cordon line around the Central Business District (the “core”) was determined by the inbound point at which there were more destinations (alighting from transit buses) than origins (loadings onto transit buses). The central business district includes the downtown area of the District of Columbia, Georgetown south of "Q" Street, N.W., the U.S. Capitol, and the nearby sections of Arlington County, Virginia, including Rosslyn, the Pentagon, Pentagon City, Crystal City and Reagan National Airport. In later years, additional cordon counts were added to the program, including:

- Vehicle counts, classification, and occupancy were taken on facilities that cross the region's center core cordon.
- Monitoring of freeway routes in the region with HOV lanes.
- Other data collection projects, including counts of commercial vehicles and roadside truck surveys.

These projects help to inform the development of regional travel forecasting computer models and provide an opportunity for trend analysis.

The most recent cordon count studies and findings include:

2006 Central Employment Core Cordon Count of Vehicular and Passenger Volumes:

This study analyzed peak period vehicle and passenger volumes entering the downtown employment area of the District of Columbia and Arlington County, Virginia⁴³. The data was collected during the months of March, April, May and June 2006.

Data were collected from 5 A.M. to 10 A.M. inbound and 3 P.M. to 8 P.M. outbound across the cordon line. Supplemental two-way counts of vehicle and person movements in both monitoring periods across four central Potomac River bridges between the District of Columbia and Arlington County were also performed.

Some of the key findings from the study include:

- Total inbound travel declined in the A.M. peak period from 467,100 person trips in 2002 to 443,000 in 2006.
- In the P.M. peak period, total outbound person travel declined from about 436,400 persons in 2002 to 427,600 in 2006
- Transit's modal share of inbound peak period trips increased from approximately 40% (about 186,200 trips) in 2002 to 43% (about 191,500 trips) in 2006. By far the largest share of transit trips were served by Metrorail, approximately 32% (about 143,100 trips).
- Transit's modal share of peak-period outbound trips increased from about 39% (171,400 trips) in 2002 to about 41% (177,000 trips) in 2006. Trips on Metrorail represented about 31% (131,500) of outbound transit trips in 2006.
- In spite of gains in transit's modal share, trips by single-occupant vehicles did not decrease in modal share or absolute terms that were of statistical significance.
- The number of person trips entering the Central Employment Core by private automobiles during the A.M. peak period in 2006 has declined from 2002, and, the decline in person trips by multiple-occupant accounts for nearly that entire decline.
- Travel crossing the Arlington, Virginia sectors of the cordon line showed little change in total, but there was a decline of over 10,000 person trips by multiple-occupant vehicles.

⁴³ The full report can be found here: <http://www.mwcog.org/uploads/committee-documents/u1daXFs20070501081323.pdf>

Appendix G contains two graphs, which depict the modal share trends from 1996 to 2006, in the inbound and outbound peak periods.

2003 District of Columbia City Line Cordon Count of Peak Period Vehicular and Passenger Volumes

This study analyzed peak period vehicle and passenger volumes entering the District of Columbia in the mornings, and leaving the District of Columbia in the evenings. Traffic count and most transit count data were collected in Spring, 2003.

Data were collected from 5 A.M. to 10 A.M. inbound and 3 P.M. to 8 P.M. outbound across the cordon line. On most streets and highways crossing the cordon line along the D.C./Maryland border, the counts were taken at a point just outside of the District of Columbia border. On the bridges crossing the Potomac River, counts were taken of traffic as it crossed the river.

Results were compared against the previous D.C. City Line Cordon Count conducted in Spring 1998 (**Appendix H**). Key findings of the study concluded:

- During the three hour inbound A.M. peak period (6:30 to 9:30), person trips by all modes increased from 395,000 in 1998 to 406,000 in 2003, an increase of about 11,000. Trips on transit in this period increased by about 23,000.
- Trips by SOVs showed little change between 1998 and 2003. Similarly, inbound motor vehicle traffic during this period showed little change.
- For the full five hour A.M. inbound monitoring period (5 A.M. to 10 A.M.), person trips by all modes increased from 492,000 in 1998 to almost 524,000 in 2003. Transit increased by about 32,000 trips, and the modal share of transit increased from 28 percent in 1998 to 32 percent in 2003.
- Vehicles crossing the D.C. City Line Cordon inbound between 5 A.M. and 10 A.M. with exactly four wheels were classified as to state of registration. For the full cordon, the following percentages and volumes were observed:
 - District of Columbia: 6% (17,000)
 - Maryland: 50% (176,000)
 - Virginia: 27% (79,000)
 - All other jurisdictions (includes all other states, territories and Canadian provinces, federal government and diplomatic registration): 8% (23,000).
- In the three-hour P.M. outbound peak period (3:30 to 6:30 P.M.), the total number of person trips was statistically unchanged between 1998 and 2003. However, there were changes in modal shares that were significant. Transit trips increased by almost 24,000 trips (and an increase of 17,500 trips on Metrorail made up the bulk of the increase), while trips in vehicles with more than once person decreased by about 13,000 trips.

2.7.2 HOUSEHOLD TRAVEL SURVEYS

The Household Travel Survey is a survey of households in the Washington region and adjacent areas to gather updated information on area wide travel patterns. The survey provides information on such important determinants of travel as household demographics, income,

employment destinations, and number of vehicles available. This data helps guide future transportation planning as the area continues to grow.

The latest Household Travel Survey was conducted by TPB staff in 2007-2008, updating the last such survey which was undertaken in 1994. Data is being collected from households across the region and some preliminary results of survey data analysis include:

- The significant increase in the proportion of single person households in the region had a dramatic impact on the average number of daily trips per household.
- Per person daily trip rates decreased moderately for persons from 5 to 34.
- Per person daily trip rates increased significantly for persons 65+.
- The share of daily trips by auto driver vehicle trips decreased 2.2 percentage points, the walk share increased by 1.6 percentage points, and the transit share increased by 0.7 percentage points.
- The biggest modal shifts between auto driver vehicle trips and the transit and walk modes were seen in the 16 to 34 and the 55 to 64 age groups.
- Persons 25 to 34 more likely to live in Regional Activity Centers.

2.7.3 SPECIAL SURVEYS AND STUDIES [TO BE UPDATED]

The TPB and its member agencies undertake special studies or data collection efforts, on both one-time and recurring bases. Examples include compiling data to form a regional travel trends report, as well as monitoring of high-occupancy vehicle (HOV) systems, transit usage, and cordon counts of traffic on specified areas of the region.

Regional Travel Trends Report:

The Regional Travel Trends report summarizes major travel trends in the metropolitan region from 2000 – 2006⁴⁴. The rate and spatial pattern of population growth are key to the underlying changes in travel trends. The metropolitan Washington region has seen a fast increase in growth over the last several decades, and with that come major changes in how and why people travel. This is important to congestion management, in that it is important in understanding why congestion may be occurring in particular areas. In addition, travel trends can help predict, and prepare for, future congestion.

The data for the Regional Travel Trends report is not compiled from just one survey or study. Rather, the data is drawn from a variety of different sources. These sources include:

- Population and worker characteristic data from the 2000 Decennial Census and the new American Communities Survey (ACS)
- Population, group quarter, and housing unit estimates from the Federal State Cooperative Program for Population Estimates (FSCPE)
- Employment and labor force data from the Bureau of Labor Statistics' Quarterly Census of Employment and Wages (QCEW)

⁴⁴ *DRAFT Regional Travel Trends Report*, December 28, 2007

- Local Area Unemployment Statistics (LAUS) program
- Highway Performance Monitoring System (HPMS)
- Travel monitoring data from:
 - DDOT
 - MDOT
 - VDOT
 - TPB Regional Transportation Data Clearinghouse
- Transit ridership statistics from the Washington Metropolitan Area Transit Authority (WMATA)
- Northern Virginia Transportation Commission (NVTC)
- Montgomery County
- Prince George's County

The Travel Trends report looks at the 2000 – 2006 trends and compares that to the trends of the previous decade, from 1990 – 2000. During the 1990s, the outer suburbs experienced the greatest population changes, with Loudoun County having the largest population increase at 97%. However, both Fairfax County and Montgomery County added more population in absolute terms than Loudoun. During the 1990's there was virtually no net increase in population in the region's Center Area jurisdictions.

Some key findings of the regional travel trends during the 2000 – 2006 time period include:

- The outer suburbs continue to grow. The greatest amount of population increase in this decade so far have been in the Outer Suburban jurisdictions of Loudoun, Prince William, and Stafford Counties in Virginia, and in Frederick, Charles, and Calvert Counties in Maryland. Loudoun and Prince William counties have already added more population in the first six years of this decade than they did in the entire ten years of the previous decade.
- If the annual growth rates observed in the Outer Suburbs from 2000 – 2006 continue, they will have added almost 500,000 people between 2000 and 2010. This would be significantly more than the 340,000 added in the Inner Suburbs between 1990 and 2000.
- A significant turnaround in the District of Columbia's population growth was seen from 2000 – 2006. Whereas the District lost population between 1990 and 2000, the city experienced a net gain of more than 10,000 residents between 2000 and 2006.
- Similar to the gain in population growth, the Outer Suburbs also experienced the greatest increase in civilian labor force between 2000 and 2006.
- The latest statistics show household vehicle availability growing at the same rate as total population increase. This is different from the 1990's statistics, which show that at that time the number of household vehicles was increasing faster than the total population.
- Weekday Vehicle Miles of Travel (VMT) in the region grew by an average annual rate of 2.4% between 2000 and 2006. This is faster than the increase in population, employment, and vehicle availability.

Local Studies:

Sometimes member state and local jurisdictions will conduct studies to analyze and evaluate their own programs, and these studies can be important to congestion management.

An example of one such project is a Maryland State Highway Administration (SHA) Congestion Relief Study (CRS) to evaluate the effectiveness reconstructing intersections had on improving congestion in 2003⁴⁵. Twelve of the fourteen intersections that were reconstructed were analyzed for “before” and “after” improvements. The study asked two questions: 1)

- Did the program meet its goal of reducing congestion? And;
- Was the program justifiable from an economic standpoint (i.e. did the benefits of the program exceed the cost?)

Overall, the study concluded that the reconstruction program was a success.

- Congestion levels were reduced at each intersection during the AM and PM peak periods. The time the average motorist waits at a traffic signal in the program was reduced by 1 minute each day.
- For the intersections in the program, average delays were reduced by 30% in the AM and 40% in the PM peak hour, compared to a no-build condition.
- Reductions in stopped time translate into travel time savings for motorists. This study shows that the CRS program saved Maryland motorists approximately 350,000 hours of waiting at traffic signals in 2003.
- In terms of economic benefits, the program is found to have an increase in \$11 Million dollars of wages and productivity (based on the average hourly income of \$18.04 in Maryland in 2002 and an average price of \$1.65 per gallon of gasoline).

Studies such as this allow agencies to evaluate the economic and other benefits of a project. This can be important to stakeholders and local decision makers to identify what projects work best where, and deciding how to make the most of transportation funds.

2.7.4 THE REGIONAL TRANSPORTATION DATA CLEARINGHOUSE

TPB compiles roadway usage data as available, collected from the region's agencies and jurisdictions. These data may come from jurisdictions' regular traffic counting efforts, special studies, permanent count stations, or other sources.

The Regional Transportation Data Clearinghouse program transforms these data into a format associated with the region's travel demand forecasting model. Compiled data are also associated with the estimated capacity of links on the region's roadway network, providing the opportunity to calculate estimated volume-to-capacity (V/C) ratios, a widely-used performance measure.

⁴⁵ *Congestion Relief Study – Category I Program Evaluation*. Maryland Department of Transportation (MDOT) State Highway Administration (SHA)

The goal of the Clearinghouse is to make traffic volume data more accessible, more accurate, and more meaningful. It provides for easy access to a wide variety of traffic volume data for many links in the regional transportation network.

An updated version of the Clearinghouse was released in 2009⁴⁶.

2.7.5 FHWA TTID PROGRAM TRAFFIC MONITORING

The Federal Highway Administration's Transportation Technology Innovation and Demonstration (TTID) Program is enabled by SAFETEA-LU to advance the deployment of intelligent transportation infrastructure⁴⁷. The purpose of this program is to address national, local, and commercial data needs through enhanced surveillance and data management in major metropolitan areas. This involves integration of data from existing surveillance infrastructure and strategic deployment of supplemental surveillance infrastructure to provide real-time and archived roadway system performance data. At the national level, the goal is to measure the operating performance of the roadway system across the nation. Made available locally, such roadway system performance data can be used to assist in local system planning, evaluation, and management activities. The same data that is useful to the public transportation agencies also has value for commercial traveler information purposes.

To date, the TTID program has completed the systems in 16 metropolitan areas, including the National Capital Region. Location-fixed detectors are the primary data collection devices and about 190 centerline miles of freeways in the region are covered by this program. The advantage of this data source lies in the continuous traffic volume information (besides speed) obtained from the detectors. Its disadvantages include typical detector-based data uncertainties (assumptions of vehicle length and segment length, mechanical failure, etc.) uneven density of coverage, not geocoded.

The Congestion Management Process is aware of this traffic monitoring activity and will be utilizing this data source to evaluate the congestion in the National Capital Region. Relevant results will be reported in future updates of the CMP Technical Report.

2.8 National Comparison of the Washington Region's Congestion

Regularly since 1982, the Texas Transportation Institute (TTI) releases an *Urban Mobility Report*⁴⁸, which outlines and compares urban congestion and mobility in all 439 urban areas across the United States. The most recent report was released in 2009 and was based on 2007 data from the National Highway Performance Monitoring System (HPMS).

Since 2007, INRIX, Inc., an independent live traffic information provider based primarily on GPS units equipped on commercial fleets, releases a *National Traffic Scorecard*⁴⁹ for the largest

⁴⁶ The *Draft Regional Transportation Data Clearinghouse User Guide* can be found at: <http://www.mwcog.org/uploads/committee-documents/al5bXVIY20090627165308.pdf>

⁴⁷ <http://ops.fhwa.dot.gov/travelinfo/ttidprogram/ttidprogram.htm>

⁴⁸ Texas Transportation Institute (TTI) and the Texas A&M University System. *The 2009 Urban Mobility Report*. July, 2009. <http://mobility.tamu.edu/ums/>

⁴⁹ INRIX, Inc., National Traffic Scorecard, <http://scorecard.inrix.com/scorecard/>

100 metropolitan areas in the U.S. The most recent traffic scorecard was released in 2010 and was based on 2009 data.

Both national reports use several different performance measures, which greatly impacts the rankings of cities (Table 7). For example, the TTI study concludes that the Washington region is ranked second in terms of national congestion, the ranking of the report often cited in the local press. This particular ranking uses travel delay per person as the performance measure. If a different measure, travel time index (the ratio of travel time in the peak period to travel time under free flow conditions), is used, the Washington region is ranked fourth. The INRIX report only uses peak period (6 am – 10 am and 3 pm – 7 pm) travel time index and peak period overall congestion two measures. The latter is defined as “overall congestion = sum of (travel time index that larger than 1 multiplied by segment length)” and is expressed as the percentage of the worst city in the country.

Table 7. National Comparison of the Washington Region’s Congestion

Measures	Texas Transportation Institute (2007 data)		INRIX National Traffic Scorecard (2009 data)	
	Value	Rank	Value	Rank
Overall congestion	/	/	38% of nation’s worst metro area (Los Angeles)	4
Travel time index	1.39	4	1.22	3
Annual delay per traveler	62 hours	2	/	/
Wasted fuel per traveler	42 gallons	2	/	/
Travel delay	133,862,000 hours	7	/	/
Excess fuel consumed	90,801,000 gallons	8	/	/
Congestion cost	\$ 2,762 million	7	/	/
Congestion trends – wasted hours (annual delay per traveler, 1982 to 2007)	46 hours increase (from 16 to 62 hours)	1	/	/
Congestion trends – wasted time (travel time index, 1982 to 2007)	28 points increase (from 1.11 to 1.39)	4	/	/
Solutions to congestion problems - operational treatment savings	10,517,000 hours, or \$216.1 million	7	/	/
Solutions to congestion problems - public transportation savings	26,285,000 hours, or \$521.1 million	5	/	/

There are some limitations to the TTI report. The TTI report provides average conditions across the region, not location-specific information that only a regional congestion monitoring program, such as that done for freeways and arterials in our region, can provide. In addition, even though the methodology has improved over time and attempts to include the impacts of transit, HOV lanes, demand management, and some operational improvements, it still cannot estimate

performance on a specific corridor. For INRIX report, the regional measures are summarized based on segment length rather than vehicle miles of travel (VMT) of the segment (the way TTI does), due mainly to lack of traffic volume information in their data source.

The primary value of the TTI report is not in identifying rankings, but rather in studying how urban areas across the county are doing over time. The report states that the Washington region is not unique in dealing with congestion, stating that congestion is worsening in urban areas of all sizes. However, it also mentions the benefits of congestion management strategies that many cities, such as the Washington, DC area, are considering. Operational and demand management strategies, such as providing more travel options, adding capacity, managing the demand, increasing efficiency of the system, and managing construction and maintenance projects, all noted in the report, are all robust strategies that will continue to be pursued by TPB member agencies.

2.9 Performance and Forecasting Analysis of the 2009 Financially Constrained Long-Range Transportation Plan (CLRP)

The CLRP includes all regionally significant transportation projects and programs planned in the Metropolitan Washington region over the next 25 years. Each year the CLRP is updated to include new projects and programs. TPB produces a performance analysis of every CLRP, which examines trends and assesses future levels of congestion and other performance measures. The 2009 CLRP Performance Analysis⁵⁰ provides both an overall assessment of the anticipated impacts of the CLRP, as well as an indication of future levels of congestion relevant to the CMP. The 2009 CLRP Performance Analysis uses a base year of 2010 in the analysis, along with COG's Cooperative Forecasting (Round 7.2) information (see Section 3.2.5), and the Travel Demand Model Version 2.2.

Plan performance analyzes the outlook for growth in the region. One of the cornerstones of plan performance is the forecasting of future congestion. The plan performance looks at where in the region congestion will occur in the future and compares current congestion to future congestion. It looks at criteria that may effect congestion, such as changes in population, employment, transit work trips, vehicle work trips, lane miles, and lane miles of congestion. The analysis also breaks down lane miles of congestion into core, inner suburbs, and outer suburbs, providing information on where, generally, the most lane miles of congestion can be found in 2010 compared to 2030.

Several factors are analyzed which are important to congestion management, such as changes in growth and travel demand from 2010 – 2030 (Figure 33). While the analysis shows a percentage increase in VMT and lane miles of congestion, there is also anticipated to be an increase in transit work trips. In addition, the analysis shows a small decline in VMT per capita.

⁵⁰ Performance of the 2009 CLRP Update, <http://www.mwcog.org/clrp/performance/>

Figure 33: Change in Land Use and Travel Forecast

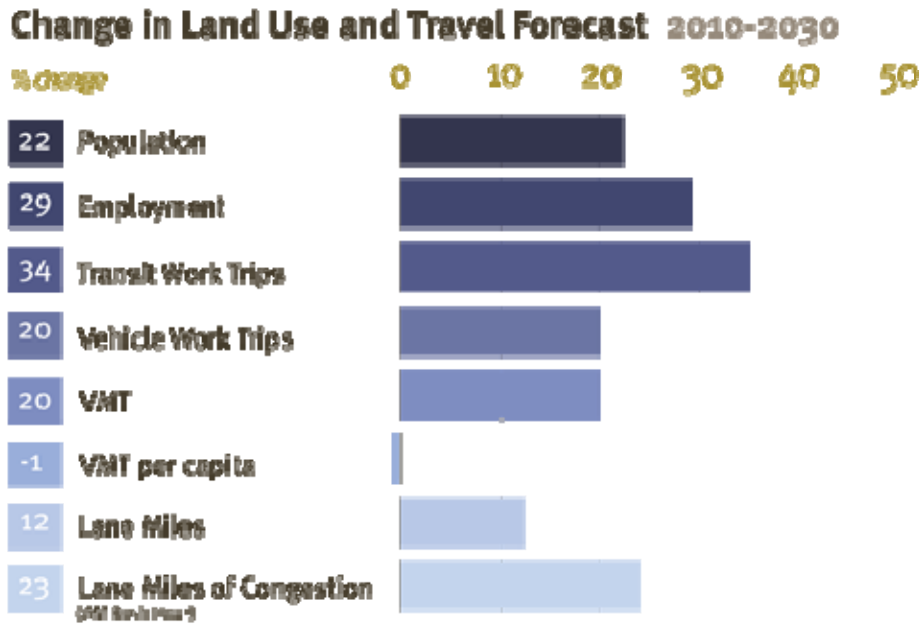

The region as a whole is growing steadily. However, growth is much faster in the outer jurisdictions. In terms of lane miles of congestion in the AM rush hour, the biggest increase will be found in the outer suburbs, followed by the inner suburbs and the regional core, respectively (Figure 34). In addition, the number of jobs accessible within 45 minutes will continue to grow, but the number will be greater for transit-accessible jobs in that category (Figure 35).

Figure 34: Change in Lane Miles of Congestion.

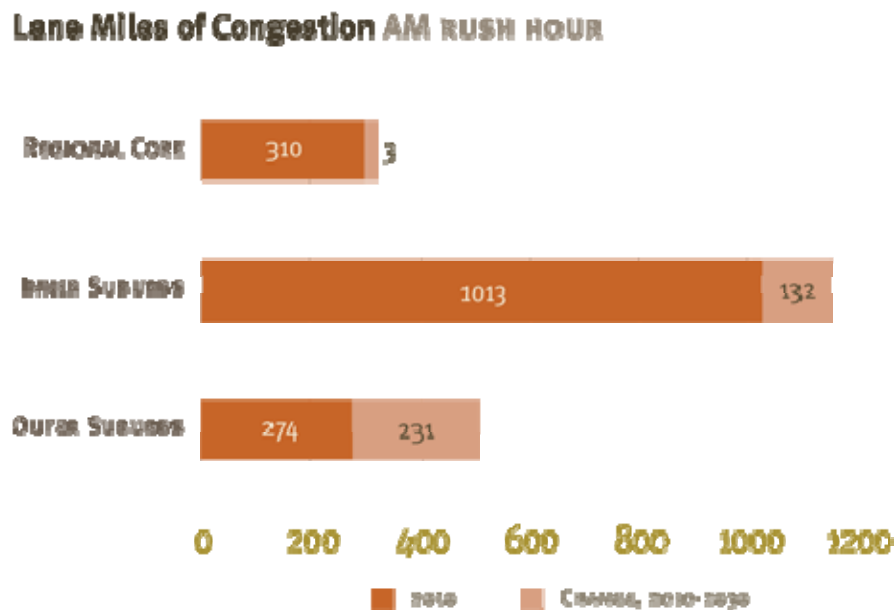

Figure 35: Average Number of Jobs Accessible Within 45 Minutes.

Average Number of Jobs within 45 Minutes 2010-2030

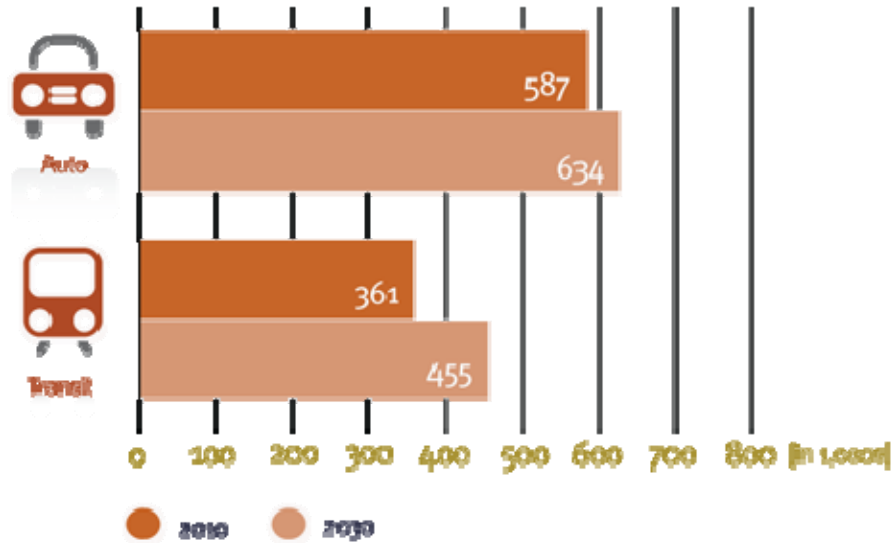

Figure 36 compares highway locations of moderate (dash yellow line) and severe (solid red line) congestion in the evening peak period in 2008 and 2030. There is a significant portion of I-495 in Maryland and Virginia experiencing generally free-flow conditions in 2008 that will experience more moderate congestion in 2030. In addition, some areas with moderate congestion, such as on a portion of I-66 in Virginia and I-295 in Maryland, will experience severe congestion in the future.

While it is evident that congestion may be getting worse in some areas by 2030, this is not true for all areas. Improvement is also evident, such as around the I-95 HOT lanes in Virginia.

Figure 37 shows forecasted congestion for Metrorail during the morning commute. Due to a lack of funding for capacity enhancement projects identified to accommodate all of the projected ridership growth, the Metrorail system will gradually approach capacity on trips “to and through” the regional core. According to a WMATA study, in 2010, 50% of the trains will be running with 8-cars, which will bring relief to peak crowding on all lines; however, without additional railcars beyond what is currently funded, the Orange Line and future Dulles Rail Line between Courthouse and Rosslyn stations are expected to exceed capacity by 2020, and the entire Metrorail system will approach capacity by 2030.

WMATA defines line capacity as an average of 120 passengers per car at the maximum load segment in the peak direction during the peak hour; however, passengers on individual trains during the peak of the peak hour may experience crowding beyond 120 passengers per car. To help put things in perspective, a Metrorail car generally provides about 70 seats, and the crush load for a car is around 180 passengers.

Figure 36: Congestion on Regional Highways. 2008 Compared to 2030.

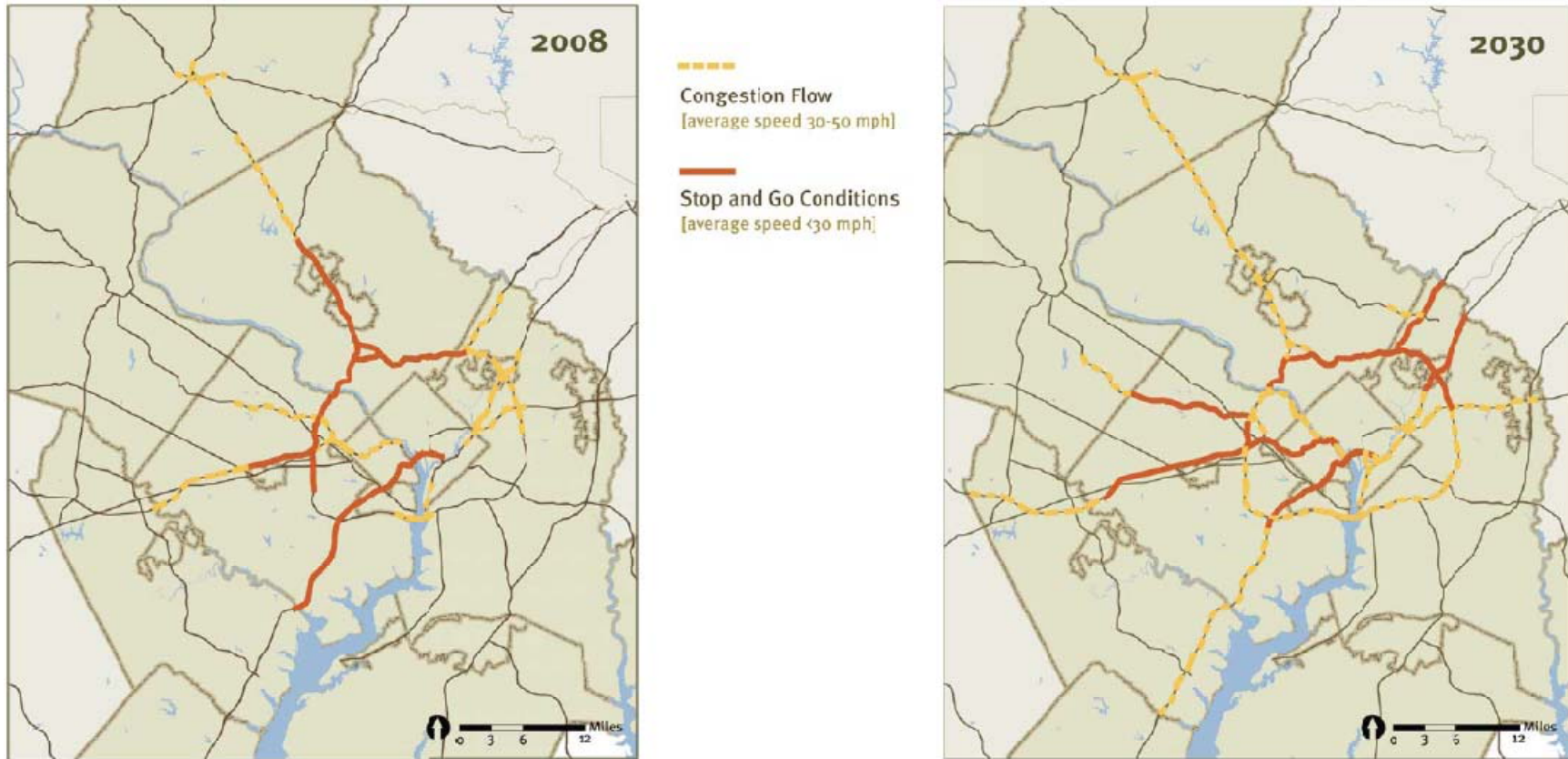
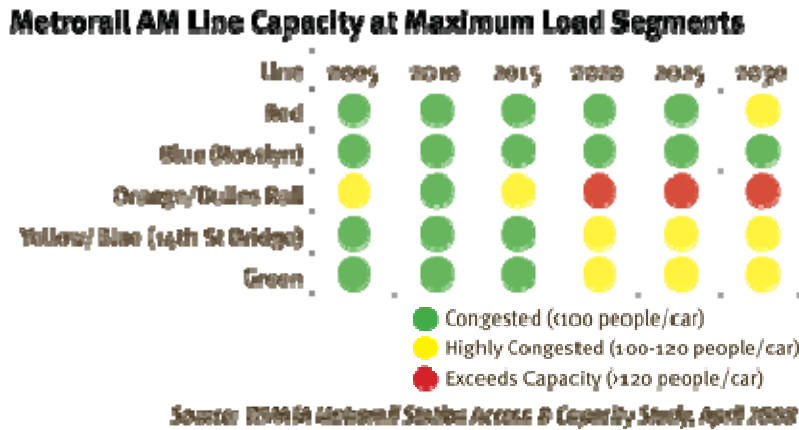
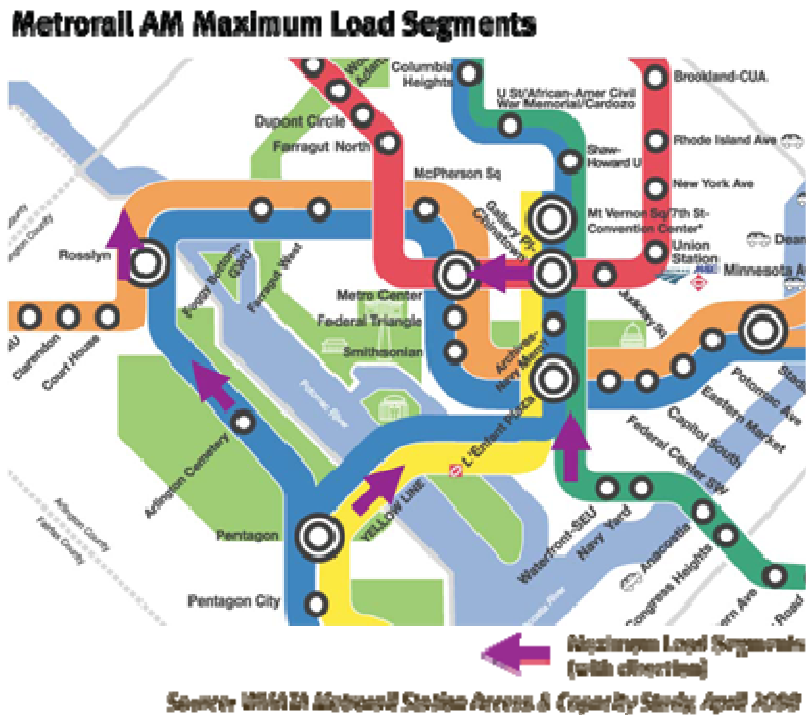

Figure 37: Forecasted Congestion for Metrorail during the Morning Commute



Some overall conclusions of the plan performance analysis are:

- Population and employment growth are outpacing levels of transportation investment, resulting in worsening congestion.
- The rate of population and employment growth is much more rapid in outer jurisdictions.
- Transit trips are heavily focused in activity centers, but clusters are not growing any faster than the rest of the region.

3. CONSIDERATION AND IMPLEMENTATION OF CONGESTION MANAGEMENT STRATEGIES

3.1 Overview of Demand Management and Supply Management

Congestion Management Strategies generally can be divided into two types – Demand Management strategies and Operational, or Supply Management strategies.

Demand Management is aimed at reducing the demand for travel and influencing travelers behavior; either overall or by targeted modes. Demand Management strategies can include carpooling, vanpooling, telework programs that allow people to work from home to reduce the amount of cars on the road, and living near your work as a means of reducing commute travel.

Supply management, on the other hand, is managing and making better use of existing transportation modes in order to meet the region's transportation goals and ultimately improve congestion. Example supply management strategies are High-Occupancy Vehicle (HOV) lanes, variably priced lanes, transit systems, and nontraditional modes.

These strategies, and how they are implemented throughout the Washington region, are explained in further detail below. It should be noted that although strategies are divided into two categories, many times demand management and operational management strategies work together and are not stand-alone strategies.

3.2 Demand Management Strategies

3.2.1 COMMUTER CONNECTIONS PROGRAM

Commuter Connections is a regional network, coordinated by COG/TPB, which provides commuter information and assistance services to those living and working in the Washington, DC region. The Commuter Connections program is designed to inform commuters of the availability and benefits of alternatives to driving alone, and to assist them in finding alternatives to fit their commuting needs. The program is funded by the District of Columbia, Maryland, and Virginia Departments of Transportation, as well as the U.S. Department of Transportation, and all services are provided free to the public and employers. Continuing the Commuter Connections Program is one of the key recommendations of the 2010 CMP Technical Report.

- **Transportation Emission Reduction Measures (TERMs) Evaluation**

The programs that Commuter Connections promote are important demand management strategies because they can influence traveler behavior and ultimately help to reduce congestion. They also are crucial to reducing vehicle emissions, which is why Commuter Connections, in concert with program partners, is responsible for implementing a number of Transportation Emission Reduction Measures (TERMs) to meet air quality conformity and federal clean air mandates. Commuter Connections sets goals on TERM programs that impact commute trips⁵¹,

⁵¹ The region has adopted and implemented TERMS other than those in the Commuter Connections program. Some other TERMS, such as for Signal Timing Optimization, may also impact congestion. Others, such as for emissions control equipment on heavy-duty diesel vehicles, impact only emissions.

and evaluates the TERMS to determine the impact they are having on reducing congestion and vehicle emissions. These TERMS include:

- **Maryland and Virginia Telework** – Provides information and assistance to commuters and employers to further in-home and telecenter-based telework programs.
- **Guaranteed Ride Home (GRH)** – Eliminates a barrier to use of alternative modes by providing free rides home in the event of an unexpected personal emergency or unscheduled overtime to commuters who use alternative modes.
- **Employer Outreach** – Provides regional outreach services to encourage large, private-sector and non-profit employers voluntarily to implement commuter assistance strategies that will contribute to reducing vehicle trips to worksites, including the efforts of jurisdiction sales representatives to foster new and expanded trip reduction programs.
- **Mass Marketing** – Involves a large-scale, comprehensive media campaign to inform the region's commuters of services available from Commuter Connections as one way to address commuters' frustration about the commute.
- **InfoExpress Kiosks** – This is a project that is part of the Integrated Rideshare TERM and involves self-service electronic kiosks located in the District of Columbia and in northern Virginia that offer information on commute options and allow for remote submittal of ridematch and GRH registration applications.

Commuter Connections evaluates the impacts of these TERMS through the Commuter Connections Transportation Demand Management Evaluation Project.⁵² The evaluation process allows for both on-going estimation of program effectiveness and for annual and triennial evaluations.

Both qualitative and quantitative types of performance measures are included in the evaluation process to assess effectiveness. First, measures reflecting commuters' and users' awareness, participation, utilization, and satisfaction with the program, and their attitudes related to transportation options are used to track recognition, output, and service quality.

- Vehicle trips reduced
- Vehicle miles of travel (VMT) reduced
- Emissions reduced: Nitrogen Oxides (NO_x), Volatile Organic Compounds (VOC), Particulate Matter (PM_{2.5}), PM 2.5 pre-cursor NO_x, and CO₂ emissions (Greenhouse Gas Emissions - GHG)

Particularly of interest to congestion management is the impact on vehicle trips reduced, vehicle miles of travel (VMT) reduced, and cost effectiveness. [Appendix I](#) shows the summary of results for individual terms (i.e., how many daily vehicle trips were reduced and the daily VMT reduced compared to the goals set by Commuter Connections).

Commuter Connections also operates the Commuter Operations Center (COC), providing direct commute assistance services, such as carpool and vanpool matching through telephone and

⁵² *Transportation Emission Reduction Measure (TERM) Analysis Report FY 2006-2008*, January 27, 2009.

internet assistance to commuters. The COC is not an “official” TERM, however, it supports all other TERMS.

In addition, a variety of surveys (the following lists a subset of them) are conducted by Commuter Connections to follow-up with program applicants and assess user satisfaction on TERMS. These surveys provide data used to estimate program impacts. Some of the surveys, such as the Applicant Placement survey and Guaranteed Ride Home (GRH) Survey, also provide information used by Commuter Connections staff to fine tune program operations and policies.

- ***Commuter Connections Applicant Placement Rate Survey*** – Since May 1997 Commuter Connections has conducted commuter applicant placement surveys to assess the effectiveness of the Commuter Operations Center and other program components. The surveys assess users’ perceptions of and satisfaction with the services provided.
- ***GRH Applicant Survey*** – Commuters who register with the GRH program or use a one-time exception trip will be surveyed to establish how the availability and use of GRH influenced their decision to use an alternative mode and to maintain that mode. Satisfaction with GRH services also will be polled.
- ***State of the Commute Survey (SOC)*** – The SOC survey, a random sample survey of employed adults in the Washington metropolitan region, serves several purposes. First, it establishes trends in commuting behavior, such as commute mode and distance, and awareness and attitudes about commuting, and awareness and use of transportation services, such as HOV lanes and public transportation, available to commuters in the region.
- ***Employee Commute Surveys*** – Some employers conduct baseline surveys of employees’ commute patterns, before they develop commuter assistance programs and follow-up surveys after the programs are in place.
- ***Employer Telework Assistance Follow-up Survey*** – Sent to employers that received telework assistance from Commuter Connections to determine if and how they used the information they received.
- ***Bike-to-Work Day Participant Survey*** – A survey among registered participants in the Bike-to-Work Day event is undertaken to assess travel behavior before and after the Bike-to-Work Day, as well as commute distance and travel on non-bike days.
- ***Carshare Survey*** – A survey about the experiences of carshare users and the impact carsharing has on travel patterns in the region. The survey examines characteristics of carshare trips, travel changes made in response to carshare availability, and auto ownership and use changes in response to carshare availability.
- ***Vanpool Driver Survey*** – a survey that collects data on van ownership and operation, vanpool use and travel patterns, availability and use of vanpool assistance and support services, and issues of potential concern to vanpool drivers.

Both the TERM evaluation and associated surveys are key to assessing the impact these programs have on air quality and congestion management. Following is a more detailed analysis on the above TERMS and other Commuter Connections demand management strategies in our region.

3.2.1.1 Telework

Teleworking, or telecommuting, can be described as a means of using telecommunications and information technology to replace work-related travel. This can be done by working at one's home, or at a designated telework center one or more days a week. There are designated telework centers throughout the region, in the District, Maryland, and Virginia. Phones, fax machines, and computers make teleworking an easy alternative to getting in a car and driving long distances to an office. Teleworking has shown to boost the quality of life, have economic benefits, reduce air pollution, and ease traffic congestion.

Telework is a TERM evaluated by Commuter Connections. Telework Outreach is a resource service to help employers, commuters, and program partners initiate telework programs. In evaluating teleworking, several travel changes need to be assessed, including: trip reduction due to teleworking, the mode on non-telework days, and mode and travel distance to telework centers.

Telework impacts are primarily estimated from the State of the Commute survey and by surveys conducted of employers directly requesting information from Commuter Connections. The most recent SOC survey⁵³ concluded the following regarding teleworking:

- Teleworkers accounted for 18.7% of all regional commuters. That is, workers who travel to a main work location on non-telework days.⁵⁴
- An additional 24% of commuters said they “would and could” telework, that is, they have job responsibilities that could be done while teleworking and would be interested in teleworking, if given the opportunity.
- More than half of those surveyed (56%) said they teleworked at least one day a week.

The *TERM Analysis Report for FY 2006-2008* estimated the impacts of teleworking. The following are some noteworthy statistics from that report:

- In 2008, approximately 456,000 regional workers were telecommuting at least occasionally, about 17.4% of the total workforce and nearly 19% of all workers who are not self-employed, working only at home. This number of teleworkers represented an increase of 43% over the 2005 number of 318,130 teleworkers and several times the 1996 baseline of 150,900 teleworkers.
- The Telework TERM reduced 21,866 daily vehicle trips and 413,703 VMT. These numbers were about twice the goal for the TERM.

⁵³ 2007 *Commuter Connections State of the Commute Survey*. Prepared for Metropolitan Washington Council of Governments. Prepared by: LDA Consulting, Washington, DC. In conjunction with: CIC Research, San Diego, CA. June 2008. <http://www.mwcog.org/uploads/pub-documents/yldZWA20080903151902.pdf>

⁵⁴ Using this base of commuters excludes workers who are self-employed and for whom home is their only workplace.

3.2.1.2 Employer Outreach

Employer Outreach is aimed at increasing the number of private and non-profit employers implementing worksite commuter assistance programs, and is ultimately designed to encourage employees of client employers to shift from driving alone to alternative modes.

In this TERM, jurisdiction-based sales representatives contact employers, educate them about the benefits commuter assistance programs offer to employers, employees, and the region and assist them to develop, implement, and monitor worksite commuter assistance programs.

The *TERM Analysis Report for FY 2006-2008* estimated the impacts of employer outreach. The following are some noteworthy statistics from that report:

- Employers participating in Employer Outreach substantially exceeded the goal, with 852 participating employers compared to the goal of 581.
- Estimated trip reduction and VMT reduction for Employer Outreach were about eight percent under the goals for this TERM, due primarily to a change in the calculation method used in 2008, which applied more conservative assumptions about the impacts of financial incentives on employees' travel behavior.

3.2.1.3 Live Near Your Work

Population and growth can be considered a wonderful thing for a region, but with it comes side effects of congestion. The trend of employees living further from their job is worsening, creating longer commutes. 'Live Near Your Work' is a program to help bridge the gap between the workplace and home. The program is primarily geared towards employers in an attempt to improve their employees' work-life balance. In turn, the results of employees living closer to where they work can reduce the number of cars on the road, which ultimately can ease congestion and have positive environmental impacts.

To promote the 'Live Near Your Work' initiative, Commuter Connections provides housing information in an online Employer's Resource Guide. The tool highlights various housing programs and resources available for the Washington area workforce and aims to assist employees with moving closer to where they work. This guide also provides a list of flexible commuter options available through Commuter Connections. Used in tandem, employers have a number of ways to provide the information workers need to make living near and getting to work a reality. Employers can work with their internal staff to find and execute the right fit for their employees, and ultimately help everyone feel "more connected." Employers can find that this can have a true impact on their bottom line.

3.2.1.4 Carpooling, Vanpooling, Ridesharing and other Commuter Resources

Commuter Connections provides information on carpooling, vanpooling, and Ridesharing. These alternative commute methods reduce the amount of single occupant vehicles (SOVs) on the road, which is important to congestion management.

- **Carpooling** is two or more people traveling together in one vehicle, on a continuing basis.
- **Vanpooling** is when a group of individuals (usually long-distance commuters) travel together by van, which is sometimes provided by employers. There are typically three kinds of vanpool arrangements:
 - *Owner-operated vans* — An individual leases or purchases a van and operates the van independently. Riders generally meet at a central location and pay the owner a set monthly fee.
 - *Third-party vans* — A vanpool "vendor" leases the vanpool vehicle for a monthly fee that includes the vehicle operating cost, insurance, and maintenance. The vendor can contract directly with one or more employees. The monthly lease fee is paid by the group of riders.
 - *Employer-provided vans* — The employer (or a group of employers) buys or leases vans for employees' commute use. The employer organizes the vanpool riders and insures and maintains the vehicles. The employer may charge a fee to ride in the van or subsidize the service.
- **Ridematching Services** enables commuters to find other individuals that share the same commute route and can carpool/vanpool together. This provides carpooling options for people who may not know of someone to carpool with, thus broadening the carpooling options

3.2.1.5 Bike To Work Day

Each May thousands of area commuters participate in Bike to Work Day, sponsored by Commuter Connections and the Washington Area Bicyclist Association.⁵⁵ The TPB has a Bike to Work Day Steering Committee which coordinates the event each year.

Bike to Work Day encourages commuters to try bicycling to work as an alternative to solo driving. The program has grown enormously attracting over 7,869 bicyclists in 2009.

Biking and other nontraditional modes are expanded upon in [Section 3.2.4](#).

3.2.2 LOCAL AND OTHER TRANSPORTATION DEMAND MANAGEMENT AND TRAFFIC MANAGEMENT ACTIVITIES

Local agencies and organizations, such as local governments and Transportation Management Areas (TMAs) are doing their part to promote alternative commute methods and other demand management strategies. [Table 8](#) provides detailed information on specific ongoing demand management strategies in the Washington region.

⁵⁵ Commuter Connections *Bike to Work Day 2009* report.

Table 8: Ongoing Local Jurisdictional Transportation Demand Management (TDM) Strategies

<i>Geography</i>	<i>Location</i>	<i>Local Jurisdiction / Organization</i>	<i>Strategy Name</i>	<i>Operational or Demand Mngt. Strategy</i>	<i>Project/Program Name</i>	<i>Description</i>	<i>Website</i>
Region-wide	Region-wide	WMATA	Public Transportation Improvements	Demand	Metrobus transit	Public bus service available throughout the region. Connects to other modes: Metrorail, commuter rail, park-and-ride lots, etc.	http://w mata.com/bus/
Region-wide	Region-wide	WMATA	Public Transportation Improvements	Demand	Metrorail transit	Public rail services DC, MD, and VA. Connects to commuter rail, Metrobus and local bus systems.	http://w mata.com/rail/
Region-wide	Region-wide	WMATA	Park-and-ride lot improvements	Demand	Metrorail station park-and-ride lots	Parking offered at 42 Metrorail stations.	http://w mata.com/rail/parking/
State/Multi-jurisdictional	Maryland State-wide	MDOT	Pedestrian, Bicycle, and Multimodal Improvements	Demand	Maryland Bicycle and Pedestrian Advisory Committee (MBPAC)	Provides information on biking, walking. Master Plan guides bike/ped planning in the State.	http://w w w .mdot.state.md.us/Planning/Bicycle/BikePedPlanIndex
State/Multi-jurisdictional	Maryland State-wide	MDOT	Telecommuting	Demand	MDOT's Telework Partnership with Employers	Offers free teleworking consulting services to Maryland employers. Promotes teleworking.	http://w w w .mdot.state.md.us/Planning/Telework%20Partnership%20Web%20Page/Telework%20Partnership%20with%20Employers
State/Multi-jurisdictional	Maryland State-wide	MDOT	Employer outreach / mass marketing	Demand	MDOT's Commuter Choice Maryland	Reaches out to Maryland employers and offers incentives to implement a commuter program.	http://w w w .commuterchoicemaryland.com/
State/Multi-jurisdictional	Maryland State-wide	MTA	Public Transportation Improvements	Demand	MDOT's MARC train	Maryland MTA Public commuter rail serving Montgomery County, Prince William County, Frederick County, and into DC.	https://w w w .mtamaryland.com/services/marc/index.cfm
State/Multi-jurisdictional	Maryland State-wide	MTA	Public Transportation Improvements	Demand	Local bus	Maryland MTA Public bus service throughout Maryland, primarily around the Baltimore-DC area.	https://w w w .mtamaryland.com/services/bus/routes/bus/

Geography	Location	Local Jurisdiction / Organization	Strategy Name	Operational or Demand Mngt. Strategy	Project/Program Name	Description	Website
State/Multi-jurisdictional	Maryland State-wide	MTA	Public Transportation Improvements	Demand	Commuter Bus	Maryland MTA Commuter bus service in Maryland and DC's inner-ring suburbs.	https://www.mtmaryland.com/services/commuterbus/
State/Multi-jurisdictional	District-wide	DDOT	Pedestrian, Bicycle and Multimodal Improvements	Demand	Bicycle and Pedestrian Programs	Committed to providing safe and convenient bicycle and pedestrian access throughout the City.	http://ddot.dc.gov/ddot/cwp/view,a,1245,q,630997,ddotNav_GID,1586,ddotNav,%7C32399%7C.asp
State/Multi-jurisdictional	District-wide	DDOT	Carsharing Programs	Demand	DDOT Carsharing Initiative	A network of vehicles offered for rent to the public. Allows mobility of a car without owning one.	http://ddot.dc.gov/ddot/cwp/view,a,1250,q,631522,ddotNav_GID,1745,ddotNav,%7C34000%7C.asp
State/Multi-jurisdictional	District-wide	DDOT	Public Transportation Improvements	Demand	DDOT Mass transit	DDOT helps coordinate mass transit with agencies and WMATA.	http://ddot.dc.gov/ddot/cwp/view,a,1250,q,638123,ddotNav_GID,1586,ddotNav,%7C32399%7C.asp
State/Multi-jurisdictional	Takoma Park and Takoma Park, MD	DDOT	Growth Management	Demand	DDOT's Takoma Transportation Study	A study done for Takoma area of DC and adjacent Takoma Park, MD. Study recommends pedestrian, bicycle, transit, and road improvements.	http://ddot.washingtondc.gov/ddot/cwp/view,a,1249,q,561963.asp
State/Multi-jurisdictional	Downtown DC	Partnership of DDOT, WMATA, and DC Surface Transit	Public Transportation Improvements	Demand	DC Circulator	A public bus system serving downtown DC.	http://www.dccirculator.com/DCCirculator.html#home
State/Multi-jurisdictional	Throughout VA	VDRPT	Telecommuting	Demand	VDRP Telework/VA	Primary resource for agencies to start a telework program in VA, \$50,000 incentive to enhance the program.	http://www.teleworkva.org/
State/Multi-jurisdictional	Northern Virginia	Virginia Megaprojects-VDOT and VDRPT	Variably Priced Lanes, Public Transportation Improvements, Alternative Commute Programs	Demand	Virginia Megaprojects	A series of large-scale transportation improvements designed to ease congestion, provide better choice for commuting	http://www.vamegaprojects.com

Geography	Location	Local Jurisdiction / Organization	Strategy Name	Operational or Demand Mngt. Strategy	Project/Program Name	Description	Website
State/Multi-jurisdictional	Northern Virginia	Virginia Megaprojects-VDOT and VDRPT	Transportation Management Program	Demand/operational	Regional, Dulles Rail, and Beltway HOT lanes TMP's	Various TDM and Transit improvements to mitigate impacts and delays caused by construction of large scale projects in Northern Virginia	http://www.vamegaprojects.com
State/Multi-jurisdictional	Northern Virginia	Virginia Megaprojects-VDOT and VDRPT	Alternative Commuter Programs	Demand	Virginia Megaprojects Employer Solutions	The Employer Solutions are designed to help employers create new approaches or enhance existing services to keep your employees moving during construction.	http://www.vamegaprojects.com/employer-solutions/
State/Multi-jurisdictional	Northern Virginia	Virginia Megaprojects-VDOT and VDRPT	Alternative Commuter Programs	Demand	Virginia Megaprojects Commuter Solutions	Provide a wide range of options and information to help commuters get around construction.	http://www.vamegaprojects.com/commuter-solutions/
State/Multi-jurisdictional	Northern Virginia	VDOT and VDRPT	Public Transportation Improvements	Demand	Tysons Express	Regional bus services to and around Tysons that will provide more transportation choices and help commuters during the construction of Megaprojects.	http://www.drpt.virginia.gov/news/details.aspx?id=452
State/Multi-jurisdictional	Between DC and Richmond, VA	VDRPT	Public Transportation Improvements	Demand	VDRP Corridor Improvement Program	A program to increase capacity and reliability of rail service between Richmond and DC. Includes VRE.	http://www.drpt.virginia.gov/projects/washingtoncorridor.aspx
State/Multi-jurisdictional	Fairfax and Loudoun Co. VA	VDRPT	Public Transportation Improvements	Demand	VDRP Dulles Corridor Metrorail Project	In cooperation with WMATA and local governments. Plans to construct an extension of Metrorail to Dulles Airport.	http://www.drpt.virginia.gov/projects/dulles.aspx
State/Multi-jurisdictional	I-95 and I-395 in Virginia	VDRPT	Public Transportation Improvements	Demand	VDRP I-95/I-395 TDM Study	A study to enhance TDM and transit services in the Corridor, in conjunction with the HOT lanes project.	http://www.drpt.virginia.gov/projects/TransitTDMStudy.aspx

<i>Geography</i>	<i>Location</i>	<i>Local Jurisdiction / Organization</i>	<i>Strategy Name</i>	<i>Operational or Demand Mngt. Strategy</i>	<i>Project/Program Name</i>	<i>Description</i>	<i>Website</i>
State/Multi-jurisdictional	I-66, I-95/395 HOV lanes	VDOT/NOVA	HOV Lanes	Demand	I-66 HOV Lanes, Shirley Highway HOV	Lanes available to ridesharers, those carpooling and vanpooling, and transit vehicles	www.VDOT.Virginia.gov
State/Multi-jurisdictional	Loudoun, Fairfax, Arlington, and Prince William Counties	Northern Virginia Transportation Authority	Public Transportation Improvements	Demand	NVTA's TransAction 2030 Regional Transportation Plan	Identifies a number of public transit improvements, including new park-and-ride lots throughout Northern VA.	http://www.thenovaauthority.org/projects.html
State/Multi-jurisdictional	Loudoun, Fairfax, Arlington, and Prince William Counties	Northern Virginia Transportation Authority	Alternative Commute Programs	Demand	NVTA's Mission of the Authority	Responsibilities include a general oversight of regional congestion mitigation, including carpooling, vanpooling, and other commute programs	http://www.thenovaauthority.org/mission.html
State/Multi-jurisdictional	Northern VA and the District of Columbia	VRE	Public Transportation Improvements	Demand	VRE	Commuter rail serving Northern VA and two stations in the District. Connects to local transit.	http://www.vre.org/index.html
State/Multi-jurisdictional	Prince William Co., Manassas, and several locations in VA & DC	PRTC	Public Transportation Improvements	Demand	PRTC's OmniRide	Commuter bus service along I-95 and I-66 corridor in Prince William Co., Manassas, and to several locations in VA & DC, including Metrorail stations.	http://www.prtctransit.org/omniride/index.php
State/Multi-jurisdictional	Eastern Prince William Co. and Manassas	PRTC	Public Transportation Improvements	Demand	PRTC's OmniLink	A local bus service in Eastern Prince William Co. and Manassas	http://www.prtctransit.org/omnilink/index.php
State/Multi-jurisdictional	Prince William Co. and Manassas	PRTC	Ridematching Services	Demand	PRTC's OmniMatch	A free ridematching service for carpooler and vanpoolers originating in Prince William Co and Manassas.	http://www.prtctransit.org/omnimatch/index.php

<i>Geography</i>	<i>Location</i>	<i>Local Jurisdiction / Organization</i>	<i>Strategy Name</i>	<i>Operational or Demand Mngt. Strategy</i>	<i>Project/Program Name</i>	<i>Description</i>	<i>Website</i>
State/Multi-jurisdictional	I-66, I-95/395 HOV lanes	VDOT/NOVA	HOV Lanes	Demand	I-66 HOV Lanes, Shirley Highway HOV	Lanes available to ridesharers, those carpooling and vanpooling, and transit vehicles	http://www.VDOT.Virginia.gov
State/Multi-jurisdictional	Fairfax, Loudoun, and Prince William Counties	VDOT/NOVA	Park-and-Ride Lots	Demand/operational	Commuter Park-and-Ride lots	Provides and maintains numerous park-and-ride lots	www.virginiadot.org/travel/pnrlots.asp
State/Multi-jurisdictional	Fairfax, Loudoun, and Prince William Counties	VDOT/NOVA	Bicycle Lockers	Demand/operational	Bicycle Locker Rental Program	Provides reserved bicycle lockers at several Park-and-Ride lots for an annual rental fee	http://www.virginiadot.org/travel/novamainBicycle.asp
State/Multi-jurisdictional	Dulles Toll Road HOV	MWAA	HOV Lanes	Demand	DTR HOV Lanes	Lanes available to rideshares, Those carpooling and vanpooling, And transit vehicles	www.mwaa.com
County	Throughout Montgomery County	Montgomery County, MD	Park-and-ride lot improvements	Demand	Montgomery County Park-and-Ride Lots	Provide park-and-ride lots information in the County.	http://www.montgomerycountymd.gov/tsvtmpl.asp?url=/content/DOT/transit/routesandschedules/brochures/parklots.asp
County	Throughout Prince George's County	Prince George's County Dept. of Public Works and Transportation	Public Transportation Improvements	Demand	Prince George's County TheBus	Public bus transit serving Prince George's County.	http://www.goprincegeorgescounty.com/Government/AgencyIndex/DPW&T/Transit/thebus.asp?nivel=foldmenu(2)
County	Throughout Prince George's County	Prince George's County Dept. of Public Works and Transportation	Alternative Commute Programs	Demand	Prince George's County Ride Smart Commuter Solutions	Provides information on commuter services available in Prince George's County.	http://www.ridesmartsolutions.com/
County	Throughout Prince George's County	Prince George's County Dept. of Public Works and Transportation	Park-and-ride lot improvements	Demand	Prince George's County Park-and-Ride Lots	There are 15 free park-and-ride lots available in Prince George's County.	http://www.goprincegeorgescounty.com/Government/AgencyIndex/DPW&T/Transit/park_ride.asp?nivel=foldmenu(2)

<i>Geography</i>	<i>Location</i>	<i>Local Jurisdiction / Organization</i>	<i>Strategy Name</i>	<i>Operational or Demand Mngt. Strategy</i>	<i>Project/Program Name</i>	<i>Description</i>	<i>Website</i>
County	Throughout Prince George's County	Prince George's County Dept. of Public Works and Transportation	Improving accessibility to multimodal options	Demand	Prince George's County Call-A-Bus	Bus service available to all residents of Prince George's County who are not served by existing bus or rail.	http://www.goprincegeorgescounty.com/Government/AgencyIndex/DPW&T/Transit/bus.asp?nivel=foldmenu(2)
County	Throughout Frederick County	Frederick County, MD	Public Transportation Improvements	Demand	Frederick County Transit	Public bus and paratransit services.	http://frederickcountymd.gov/index.aspx?nid=105
County	Throughout Frederick County	Frederick County, MD	Alternative Commute Programs	Demand	Frederick County Transit	Transit also offers information on alternative commute programs.	http://www.co.frederick.md.us/index.asp?NID=208
County	Throughout Fairfax County	Fairfax County, VA	Public Transportation Improvements	Demand	Fairfax Connector	Public bus system in Fairfax County. Connects to Metrorail and bus.	http://www.fairfaxcounty.gov/connector/
County	Throughout Fairfax County	Fairfax County, VA	Alternative Commute Programs	Demand	Fairfax County RideSources Program	Provides information on alternative commute programs.	http://www.fairfaxcounty.gov/fcdot/sources.htm
County	Throughout Fairfax County	Fairfax County, VA	Alternative Commute Programs	Demand	Fairfax County Employer Services Program	Help business and employees find best transportation solutions	http://www.fairfaxcounty.gov/fcdot/employer.htm
County	Throughout Fairfax County	Fairfax County, VA	Alternative Commute Programs	Demand	Fairfax County Bike Program	A comprehensive bicycle initiative and program committed to making Fairfax County bicycle friendly	http://www.fairfaxcounty.gov/fcdot/bike/
County	Throughout Fairfax County	Fairfax County, VA	Alternative Commute Programs	Demand	Fairfax County Pedestrian Program	A comprehensive Pedestrian Program to provide dedicated resources to meet specific goals	http://www.fairfaxcounty.gov/fcdot/pedestrian/
County	Throughout Arlington County	Arlington County, VA	Public Transportation Improvements	Demand	Arlington Rapid Transit (ART)	Public bus service in Arlington. Connects to Metrorail and bus.	http://www.commuterpage.com/art/
County	Throughout Arlington County	Arlington County, VA	Alternative Commute Programs	Demand	Getting Around Arlington	Provides information on alternative commute programs, and public transit.	http://www.commuterpage.com/art/villages/arl_tran.htm

<i>Geography</i>	<i>Location</i>	<i>Local Jurisdiction / Organization</i>	<i>Strategy Name</i>	<i>Operational or Demand Mngt. Strategy</i>	<i>Project/Program Name</i>	<i>Description</i>	<i>Website</i>
County	Throughout Arlington County	Arlington County, VA	Pedestrian, Bicycle and Multimodal Improvements	Demand	Arlington's BikeArlington	Initiative to encourage more people to bike often.	http://www.bikearlington.com/about.cfm
County	Throughout Arlington County	Arlington County, VA	Alternative Commute Programs	Demand	Arlington's Car-Free Diet	Promotes alternative commute methods.	http://www.carfreediet.com/
County	Throughout Arlington County	Arlington County, VA	Promote Alternate Modes	Demand	WALKArlington	Promotes walking as an alternative mode.	http://www.walkarlington.com/about/index.html
County	Throughout Arlington County	Arlington County, VA	Alternative Commute Programs	Demand	Arlington County's CommuterPage.com	Provides information on transportation options in Arlington and the DC area.	http://www.commuterpage.com/
County	Throughout Arlington County	Arlington County, VA	Growth Management	Demand	Arlington County's TDM Management for Site Plan Development	Coordinates site plan development (proposed land use) with commuter and transit services.	http://www.commuterpage.com/TDM/
County	Throughout Loudoun and from Loudoun to DC	Loudoun County, VA	Public Transportation Improvements	Demand	Loudoun County Transit	Commuter bus service from Loudoun Co. to area park-and-ride lots and downtown DC.	http://inter4.loudoun.gov/Default.aspx?tabid=969
County	Throughout Loudoun County	Loudoun County, VA	Park-and-ride lot improvements	Demand	Loudoun's Free Park-and-Ride lots	Several free park-and-ride lots are available throughout the County.	http://inter4.loudoun.gov/Default.aspx?tabid=959
County	Throughout Loudoun County	Loudoun County, VA	Alternative Commute Programs	Demand	Loudoun's Commuting options	Provides information on alternative commute programs and transit options.	http://inter4.loudoun.gov/Default.aspx?tabid=789
County	Throughout Southern Loudoun and in Northern Loudoun to Purcellville	Virginia Regional Transit (in cooperation with Loudoun Co.)	Public Transportation Improvements	Demand	Virginia Regional Transit	Public bus service within Loudoun County.	http://inter4.loudoun.gov/Default.aspx?tabid=898

<i>Geography</i>	<i>Location</i>	<i>Local Jurisdiction / Organization</i>	<i>Strategy Name</i>	<i>Operational or Demand Mngt. Strategy</i>	<i>Project/Program Name</i>	<i>Description</i>	<i>Website</i>
County	Throughout Prince William County	Prince William County, VA	Park-and-ride lot improvements	Demand	Prince William County Commuter Parking Lots	Goal is to work with VDOT and provide convenient sites to encourage residents to use transit or carpool.	http://www.pw.gov.org/default.aspx?topic=010017001530000797
City	The length of College Park, MD	City of College Park, MD	Pedestrian, Bicycle and Multimodal Improvements	Demand	College Park Trolley Trail	Trail is to run the length of the City of College Park, in the old trolley right-of-way.	http://www.thewashcycle.com/college_park_trolley_trail/
City	Throughout Greenbelt	City of Greenbelt, MD	Public Transportation Improvements	Demand	Greenbelt Connection	A local bus in Greenbelt; runs upon request.	http://www.greenbeltmd.gov/public_works/connection.htm
City	Throughout City of Frederick	City of Frederick, MD	Pedestrian, Bicycle and Multimodal Improvements	Demand	Frederick Shared use paths	Promotes the use of, and creates new shared use paths.	http://www.cityoffrederick.com/cms/files/maps/shared-use-path.pdf
City	Throughout Falls Church and to the Metro stations	City of Falls Church, VA	Public Transportation Improvements	Demand	Falls Church GEORGE	Local bus system providing service to East and West Falls Church Metrorail stations and throughout the City of Falls Church.	http://www.fallschurchva.gov/Content/CultureRecreation/GEORGEmain.aspx
City	Throughout Alexandria	City of Alexandria, VA	Alternative Commute Programs	Demand	Alexandria Rideshare / Local Motion	Promotes use of alternative modes.	http://www.alexride.org/
City	Throughout Alexandria	City of Alexandria, VA	Public Transportation Improvements	Demand	Alexandria DASH	Local bus system. Connects to Metrobus and Metrorail, VRE, and other local bus systems.	http://www.dashbus.com/
City	Throughout City of Fairfax	City of Fairfax, VA	Public Transportation Improvements	Demand	City of Fairfax's CUE	Public bus service within City of Fairfax. Also connects to Vienna Metrorail station.	http://www.fairfaxva.gov/CUEBus/CUEBus.asp
Local / Corridor-based	Along the corridor between Baltimore and DC	BWI Business Partnership	Alternative Commute Programs	Demand	BWI Business Partnership Commuter Resources	Provides information on commuter programs available to the BWI area.	http://www.bwipartner.org/index.php?option=com_content&task=view&id=21&Itemid=59

<i>Geography</i>	<i>Location</i>	<i>Local Jurisdiction / Organization</i>	<i>Strategy Name</i>	<i>Operational or Demand Mngt. Strategy</i>	<i>Project/Program Name</i>	<i>Description</i>	<i>Website</i>
Local / Corridor-based	Downtown Bethesda	Bethesda Transit Solutions (BTS)	Alternative Commute Programs	Demand	BTS Commuter Services	Provides information on alternative commute options: carpooling, biking, employer incentives.	http://www.bethesdatransit.org/
Local / Corridor-based	Downtown Bethesda	Bethesda Transit Solutions (BTS)	Public Transportation Improvements	Demand	Bethesda Circulator	Downtown Bethesda bus service.	http://www.bethesda.org/parking/circulatorinfo.htm
Local / Corridor-based	Downtown Bethesda	Downtown Bethesda Transportation Management District (TMD)	Alternative Commute Programs	Demand	Downtown Bethesda Commuter Resources	Provides information on commuter services available in the Downtown Bethesda area.	http://www.montgomerycountymd.gov/tcotmpl.asp?url=/content/dot/transit/commuter/tmdlegislation.asp#DB
Local / Corridor-based	North Bethesda	North Bethesda Transportation Center (Transportation Action Partnership)	Alternative Commute Programs	Demand	North Bethesda Commuter Resources	Provides information on commuter services available in the North Bethesda area.	http://www.nbtc.org/
Local / Corridor-based	North Bethesda	North Bethesda Transportation Management District (TMD)	Alternative Commute Programs	Demand	North Bethesda Commuter Resources	Provides information on commuter services available in the North Bethesda area.	http://www.montgomerycountymd.gov/tcotmpl.asp?url=/content/dot/transit/commuter/tmdlegislation.asp#NB
Local / Corridor-based	Friendship Heights	Friendship Heights Transportation Management District (TMD)	Alternative Commute Programs	Demand	Friendship Heights Commuter Resources	Provides information on commuter services available in the Friendship Heights area.	http://www.montgomerycountymd.gov/tcotmpl.asp?url=/content/dot/transit/commuter/tmdlegislation.asp#FH
Local / Corridor-based	Downtown Silver Spring	Downtown Silver Spring Transportation Management District (TMD)	Alternative Commute Programs	Demand	Silver Spring Commuter Resources	Provides information on commuter services available in the Silver Spring area.	http://www.montgomerycountymd.gov/tcotmpl.asp?url=/content/dot/transit/commuter/tmdlegislation.asp#DSS

<i>Geography</i>	<i>Location</i>	<i>Local Jurisdiction / Organization</i>	<i>Strategy Name</i>	<i>Operational or Demand Mngt. Strategy</i>	<i>Project/Program Name</i>	<i>Description</i>	<i>Website</i>
Local / Corridor-based	Loudoun, Fairfax, and Prince William Counties	Dulles Area Transportation Association (DATA)	Alternative Commute Programs	Demand	DATA Commuter Resources	Advocates for alternative commute programs, transit needs, and transit-oriented development.	http://www.datatrans.org/about.html
Local / Corridor-based	Reston	LINK	Alternative Commute Programs	Demand	Reston's LINK Commuter Resources	Provides information on carpooling, vanpooling, and regional bus schedules.	http://www.linkinfo.org/index.cfm
Local / Corridor-based	Tyson's Corner area	Tyson's Transportation Association (TYTRAN)	Alternative Commute Programs	Demand	TYTRAN's Commuter Resources	Provides information on carpooling, vanpooling, park-and-ride lots, and telework locations.	http://www.tytran.org/index.htm
Local / Corridor-based	Northern VA - Loudoun, Fairfax, Prince William	Northern Virginia Transportation Commission (NVTC)	Public Transportation Improvements	Demand	NVTC Research on public transit and HOV performance	NVTC compiles data on regional transit systems and HOV performance.	http://www.thinkoutsidethecar.org/transit.asp
Local / Corridor-based	Northern VA - Loudoun, Fairfax, Prince William	Northern Virginia Transportation Commission (NVTC)	Alternative Commute Programs	Demand	NVTC Commuter Info	Provides information on how to use the region's transit system, bicycle and pedestrian options, HOV schedules, and park-and-ride lots.	http://www.thinkoutsidethecar.org/info.asp
Local / Corridor-based	Eastern Arlington's Potomac Yard neighborhood	Full Access Solutions in Transportation (FAST) for Potomac Yard	Growth Management	Demand	Non-profit, developer-initiated FAST	Aims at reducing single-occupant trips to the growing Potomac Yard area. Promotes transit, biking, walking. Offers discounted Metrobus shuttle.	http://fastpotomacyard.com/index.html
Local / Corridor-based	Tyson's Corner core business district	Fairfax County, VA	Public Transportation Improvements	Demand	Tyson's Connector	Lunchtime shuttle service, circulating throughout the Tyson's Corner core business district, providing free rides to those who live, work, shop, dine or visit there.	http://www.fairfaxcounty.gov/connector/routes/tysonsconnector.htm

3.2.3 TRANSIT SYSTEMS

Transit systems can improve the operation of existing roadways and systems by carrying more passengers than a single-occupant vehicle. They can also be considered demand management strategies in that they can influence a person's traveling behavior and convince them to leave their car at home. Many of the transit systems in the region are operated by transit agencies or local government agencies, including:

- [*Alexandria DASH*](#), a local bus service in Alexandria, Virginia
- [*Arlington Rapid Transit \(ART\)*](#), a bus service in Arlington County, Virginia
- [*Bethesda Circulator*](#), a downtown Bethesda bus service
- [*Central Maryland Regional Transit*](#), a bus service for the City of Laurel and a portion of Prince George's County, with additional services in Anne Arundel and Howard Counties.
- [*CUE in City of Fairfax*](#), a bus service in City of Fairfax, Virginia
- [*DC Circulator*](#) bus, serving downtown District of Columbia
- [*Fairfax Connector*](#), a bus service in Fairfax County, Virginia
- [*Frederick County TransIT*](#), a bus service in Frederick County, Maryland
- [*GEORGE*](#), a bus serving Falls Church, Virginia
- [*Greenbelt Connection*](#), bus serving Greenbelt upon request
- [*Loudoun County Transit*](#) operates commuter bus services from Loudoun to destinations that include West Falls Church Metro, Rosslyn, the Pentagon, and Washington, D.C., as well as providing services from West Falls Church Metro to and among employment sites in Loudoun County.
- [*Maryland Transit Administration \(MTA\) MARC*](#) train commuter rail, serving District of Columbia and Maryland
- [*Montgomery County Ride-On*](#), a local bus service in Montgomery County, Maryland
- [*MTA Local Bus*](#) service throughout Maryland
- [*Potomac and Rappahannock Transportation Commission \(PRTC\)*](#), providing *OmniLink*, a local bus service in Eastern Prince William County and Manassas, and *OmniRide*, commuter bus services offering service from locations throughout Prince William County and the Manassas and Gainesville areas to destinations that include the Vienna, West Falls Church and Franconia/Springfield Metrorail Stations, the Pentagon, Crystal City, Rosslyn/Ballston, downtown Washington, D.C., Capitol Hill, and the Washington Navy Yard.
- [*Prince George's County Call-A-Bus*](#), serving those in Prince George's County not served by existing bus or rail
- [*Prince George's County TheBus*](#), serving Prince George's County
- [*Virginia Railway Express \(VRE\)*](#) commuter rail serving Virginia and District of Columbia
- [*Virginia Regional Transit*](#) (in cooperation with Loudoun County Transit), a bus service in Loudoun County, Virginia
- [*Washington Metropolitan Area Transit Authority \(WMATA\) Metrobus*](#), serving the entire Washington metropolitan area
- [*Washington Metropolitan Area Transit Authority \(WMATA\) Metrorail*](#), serving the entire Washington metropolitan area
- *TIGER Grant priority bus network* [add more details].

While these transit systems are individually very important strategies, it is important to note that they work together to form an entire transit network important to our congestion management system. They work well with other strategies as well, such as VPLs and HOV lanes. In addition, with the help of Intelligent Transportation System (ITS) technologies and Advanced Traveler Information Systems, transit can be even more appealing to travelers.

The latest (2007/2008) regional household travel survey revealed that commuting transit modal share increased from 15.1% in 1994 to 17.7%, and daily transit modal share increased from 5.5% in 1994 to 6.1%⁵⁶. These increases reflect the positive effect of the region's longstanding efforts to promote transit usage.

3.2.4 PEDESTRIAN AND BICYCLE TRANSPORTATION

Walking and bicycling is gaining more attention as having positive environmental and health benefits. As a part of the region's transportation network, these activities impact congestion management as well. There are a number of things the Washington region is doing to enhance the area of bicycle and pedestrian transportation to encourage non-motorized transportation.

- Most of the area's local governments have adopted bicycle, pedestrian, trail plans, and/or policies. Bicycle or pedestrian coordinators and trail planners are now found at most levels of government.
- Most of the region's transit agencies, including WMATA, have bike racks on their buses. WMATA allows bikes on rail outside rush hour and on week-ends.
- Local governments are starting to require bicycle parking, as well as provide free on-street racks. DC requires bike parking in all buildings that offer car parking.
- In accordance with federal guidance and new state policies, pedestrian and bicycle facilities are increasingly being provided as part of larger transportation projects. A number of local jurisdictions have implemented transit oriented developments (TODs) and other walkable communities.
- VDOT has altered its secondary street acceptance requirements to mandate that streets built by private developers connect with adjacent streets and future developments in a manner that enhances pedestrian and bicycle access, and that adds to the capacity of the transportation system. Residential streets may be narrower and incorporate traffic calming features.
- Employers are investing in bike facilities at work sites, and developers are including paths in new construction.
- Specific bicycle/pedestrian campaigns are developing to encourage biking/walking, such as WALKArlington, [Localmotion](#), and [GoDCGo](#).⁵⁷
- The [Safe Routes to School](#) program, which is administered through the States, provides funding for both hard and soft improvements and programs to encourage children to walk or bicycle to school, improve safety, and reduce congestion and air pollution near schools.
- More and better on line bike and walk routing resources have become available from the private sector. Google Maps offers both walk and bike routing features. Another excellent

⁵⁶ A presentation of the 2007/2008 Household Travel Survey, May 19, 2009.

<http://www.mwcog.org/uploads/committee-documents/YV5cV1ZX20090520110217.pdf>

⁵⁷ <http://www.walkarlington.com/>

bike routing resources for the Washington region is RidetheCity.com/dc, which allows users to choose a preferred safety level.

Bicycle and pedestrian plans and projects are widespread throughout the Washington region. However, bicycling and walking has even greater potential. Many trips taken by automobile could potentially be taken by bicycle. This is especially true in areas such as Activity Centers and Activity Clusters, where a number of trips are more easily switched from motorized transportation to walking. Many people who live far from their jobs, but closer to transit or a carpool location could walk or bike to transit or the carpool instead of driving. When considering the following statistics, switching from a motor vehicle or bicycling or walking is feasible⁵⁸:

- The median work trip length for all modes in the Washington Metropolitan Statistical Area is 9.3 miles.
- Twenty-five percent of commute trips are less than 4.3 miles, a distance most people can cover by bicycle.
- The median auto driver trip (for all purposes) is only 4 miles, and 25% of all auto driver trips are less than 1.5 miles.
- Auto passenger trips, often children being taken to school, are even shorter, with a median trip distance of 2.8 miles, and 25% of trips less than 1.2 miles.

WMATA has initiated a Bicycle and Pedestrian Improvements Study for Metrorail station areas.⁵⁹ This study, anticipated to be completed in 2010, will identify strategies for encouraging more people to walk and ride their bicycle to and from Metrorail stations. It will result in recommendations for a range of physical infrastructure improvements such as more and better bicycle parking facilities, better wayfinding and signage to and from stations, and better connections to nearby trails and on-road bicycle lanes. It will also identify and present recommendations for addressing major physical barriers to walking and bicycling to stations. The study will include recommendations for programmatic improvements, for example by identifying communications and marketing strategies for encouraging multi-modal trips. It will include a phased implementation plan that prioritizes recommendations with the greatest potential to increase the walking and bicycling mode share. It will highlight best practices from other transit systems throughout the country, while also identifying strategies and venues for enhanced coordination between Metro and other stakeholders such as counties and cities in the region, federal government agencies, and private-sector businesses.

Supporting bicycle and pedestrian planning is important to congestion management. Each additional person walking or biking for a trip is one less person on the road, thus easing congestion. Pedestrian and bicycle facility planning is something that will continue to be considered in the realm of congestion management, not only as a stand-alone area, but in conjunction with transit projects and land use planning.

⁵⁸ *Bicycle and Pedestrian Plan for the National Capital Region*. July, 2006

<http://www.mwco.org/uploads/committee-documents/v1ZfW1020070726155118.pdf>

⁵⁹ WMATA, Metrorail Station Area Bicycle and Pedestrian Improvements Study. <http://tooledesign.com/metro/>

Bikesharing

The District of Columbia has a pilot bike sharing program, [Smartbike](#), with 100 bikes at ten docking stations in downtown DC. The first bike sharing system in North America, Smartbike was planned as a precursor to a much larger system, which will have 1,000 bicycles at 100 locations. The normal usage for large bike sharing systems such as Velib in Paris is five trips per day per bicycle. About 11% of bike share trips replace a drive or taxi trip. Results in DC may be different from Paris due to the higher drive share in DC.

There have been discussions on expanding bikesharing regionally. In 2009, the TPB submitted a regional application for funding from the U.S. Department of Transportation's Transportation Investments Generating Economic Recovery (TIGER) Competitive Grant Program⁶⁰. Among the packages included was a proposal for an expanded regional bikesharing and Intermodal Smart Hubs program. The program was proposed to provide 1,600 bicycles at 160 bike-sharing stations in D.C., Alexandria, Arlington County, Bethesda, and Silver Spring, as well as potential other locations such as College Park, Falls Church, and National Harbor. Though the package was not among those selected by the U.S. Department of Transportation for funding, the region may further use the proposal as a basis to explore future bikesharing expansions.

3.2.5 CAR SHARING

Carsharing is a model of car rental where people rent cars for short periods of time, often by the hour. This supports residents, especially in densely populated urban environments, who make only occasional use of a vehicle, as well as others who would like occasional access to a vehicle of a different type than they use day-to-day. Urban car sharing is often promoted as an alternative to owning a car in dense, walkable, mixed-use development communities, where public transit, walking, and cycling can be used most of the time and a car is only necessary for out-of-town trips, moving large items, or special occasions. It can also be an alternative to owning multiple cars for households with more than one driver.⁶¹

Car sharing has taken off in the Washington region, with over 500 shared [Zipcar](#)® cars in the District of Columbia alone. The District of Columbia provides on-street spaces for car share vehicles, and encourages developers to provide off-street car share spaces in conjunction with new development. DDOT projects that by 2012 there will be 750 shared vehicles in the District of Columbia. Zipcar® also has vehicles outside the District of Columbia, mostly near Metro stations.

Based on polls of members who say they either sold a vehicle or cancelled a planned purchase after joining, The company estimates that each Zipcar® takes 15 personally owned vehicles off the road. 90% of Zipcar® members drive less than 5500 miles per year.

3.2.6 LAND USE STRATEGIES IN THE WASHINGTON REGION [TO BE UPDATED]

The relationship of land use and transportation often have an important influence on a person's willingness to commute by transit, ridesharing, bicycling, or walking; modes other than driving

⁶⁰TPB TIGER grant application, www.mwcog.org/uploads/committee-documents/k15ZX1pf20100217144153.pdf.

⁶¹ Adapted from Wikipedia, "Carsharing", <http://en.wikipedia.org/wiki/Carsharing>.

alone. The TPB is undertaking projects that consider the relationship of land use and transportation, all of which are important components of the CMP. Concentrating activities near transportation facilities helps reduce the number and length of vehicle trips necessary by residents and workers. More trips can be made by walking. Densities can be sufficient to make provision of transit services cost effective.

Cooperative Forecasting

TPB coordinates with the regional Cooperative Forecasting process at COG.

Cooperative forecasting is a regional process that provides forecasts for demographic information that considers the potential impacts of future transportation facilities. The forecasts are based on national economic trends, local demographic factors, and are closely coordinated with regional travel forecasts.

Local jurisdictions develop independent projections of population, households, and employment based on pipeline development, market conditions, land use plans and zoning, and planned transportation improvements. These local forecasts are also compared and coordinated at the regional level to ensure compatibility. If there is a major change in planned transportation facilities (such as an addition or removal of a planned major facility) the cooperative forecasts are updated to reflect this change. Overall, Metropolitan Washington has strong, well-established processes to ensure transportation planning and land use planning are well-coordinated.

Regional Activity Centers and Regional Activity Clusters

The most recent round of cooperative forecasting projects increases in employment, population, and households by 2030, the end of the forecast period. Employment growth, population, and household growth is expected to increase more in the inner and outer suburbs than in the central jurisdictions. Much of this increase in employment and households is going to mean the development of new infrastructure and the expanding of already existing Regional Activity Centers and Regional Activity Clusters.

Regional Activity Centers and Regional Activity Clusters help coordinate transportation and land use planning in specific areas in the Washington region experiencing and anticipating growth. Focusing growth in Centers and Clusters is important to congestion management, where transportation options for those who live and work there can be provided. The concentration of activities and location near transportation facilities help reduce vehicle trips, as more trips can be made by walking. Transit services also become more cost effective.

The first map of Regional Activity Centers was created in 1999, and since that time it has been updated several times, based upon current local comprehensive plans and zoning. In 2007, COG released a report of Metropolitan Washington Regional Activity Centers and Clusters, which is based on Cooperative Forecasting Round 7.0.⁶²

⁶² *Metropolitan Washington Regional Activity Centers and Clusters report*, June, 2007.
http://www.mwcog.org/store/item.asp?PUBLICATION_ID=299

The report concluded that approximately 54 percent of the region's current employment and 55 percent of future jobs were located in the Activity Centers. In addition, the Activity Centers capture 58 percent of all new jobs between now and 2030. The Centers contain 13 percent of the region's existing households and nearly 16 percent of future households, a significant increase from the previous forecast. Although this number may not seem high, it is clear that Activity Centers are growing in many respects. It is important that transportation options continue to be considered for these Centers to accommodate the needs of people who live and work there.

Transportation-Land Use Connection (TLC) Program

The Transportation-Land Use Connection (TLC) program provides support and assistance to local governments in the Washington region as they implement their own strategies to improve coordination between transportation and land use.

The program does this in two ways. First, it provides information via the Regional TLC Clearinghouse, which is a web-based source of information and transportation/land use coordination, experiences with transit-oriented development, and key strategies. Secondly, the TLC Technical Assistance Program provides consultant services to local jurisdictions working on projects land use and transportation projects.

Four projects will be completed as part of the FY 2010 TLC program:

- NoMa BID, Gateway Transportation Enhancement,
- Frederick County, MD-355/MD-85 TOD Study,
- Greenbelt, Pedestrian and Bicycle Master Plan, and
- Prince George's County/Town of Cheverly, Non-motorized Transportation Study.

The TLC program allows for flexibility to study a wide variety of transportation – land use issues. Some projects are more demand management focused, focusing on pedestrian improvements, growth management, and transit oriented development. Other projects address operational issues, including pedestrian safety improvements and roadway design. The goals among each may be different, but each project is applicable to congestion management.

Local Jurisdictional Land Use Planning Activities [To be Updated]

There are also a number of activities going on at the local level that are important to congestion management. Activities range from having a strong comprehensive plan that guides local development, to the implementation of projects that include transportation options and pedestrian and bicycle facilities. Examples of local jurisdictional planning activities (note: not a comprehensive list) include:

- The *City of Alexandria* works to make sure its development proposals are consistent with the Master Plan and Zoning Ordinance. Planning and Zoning works closely with the community in each area of the City to carry out City Council's 2004-2015 Strategic Plan and Community Vision for vibrant, walkable neighborhoods, protected natural resources, and vital Main Street business districts. The City's DASH bus network provides access

to several parts of the City such as the West End Farmers Market on Sundays or the Nature Center at the Northern Virginia Regional Park Authority.

- *Arlington County's* decades-long history of transit-oriented land use development in the Rosslyn-Ballston corridor is often cited as a national example of successful land use-transportation coordination. Development in the corridor is of a density that takes advantage of being within walking distance of the Metrorail Orange Line, while preserving surrounding existing neighborhoods.
- *Fairfax County's* Comprehensive Plan was recently amended to encourage Transit-Oriented Development (TOD) with focused growth near planned and existing rail transit stations to create opportunities for compact pedestrian- and bicycle-friendly neighborhood centers accessible to transit. The implementation guidelines include the promotion of a mix of uses to maximize internal trips, ensure the efficient use of transit, and other measures to limit single occupant vehicle trips. In addition to active promotion of transportation demand management (TDM) strategies, Fairfax County also negotiates trip reduction targets coupled with developer-funded monitoring programs and imposes penalties for non-attainment.
- *Loudoun County's* comprehensive plan calls for higher densities in the eastern part of the County, generally along or near primary corridors such as Route 28 and the Dulles Toll Road, and near future planned rail stations. In addition, in 2007 a Plan Amendment called for achieving and maintaining acceptable levels of transportation along Route 50 by completing a planned road network and supporting alternative modes of transportation.
- In the *Maryland-National Capital Park and Planning Commission's* plan for the Georgia Avenue corridor, Montgomery County planners are analyzing different development scenarios along the corridor, which extends from the District of Columbia north to the Maryland County line. Sector plans are also being considered for neighborhoods surrounding the Wheaton and Glenmont Metro Stations.
- The *District of Columbia* has recently approved a number of mixed-use developments near the new baseball stadium in Southeast Washington, which will, among other impacts, facilitate pedestrian movement in a developing area. The projects contain a mix of office, hotel, retail, and residential all within easy access to the Navy Yard Metrorail station.

3.3 Operational Management Strategies

3.3.1 HIGH-OCCUPANCY VEHICLE (HOV) FACILITIES

3.3.1.1 Overview

High Occupancy Vehicle (HOV) lanes are defined as roadways or roadway segments that are restricted to use by vehicles (cars, buses, vanpools) carrying the driver and one or more additional passengers.

HOV facilities offer several advantages over conventional lanes and roads. They increase the number of persons per motor vehicle using a highway over conventional (non-HOV) roadways, they preserve the person-moving capacity of a lane or roadway as demands for transportation capacity increase, and enhance bus transit operations. All of these advantages are important to effectively managing the operations of existing and new capacity on roadways.

However, HOV facilities can also be considered demand management strategies as well, providing predictable travel times even during peak periods of high demand for highway capacity. HOV lanes can help influence travelers' behavior and provide them with additional choices of how, or if, to travel a certain route.

Currently there are five HOV facilities in the Washington region on highways functionally classified as freeways:

- I-66 in the Northern Virginia counties of Prince William, Fairfax, and Arlington (this HOV system includes a section of the Dulles Connector in McLean, connecting to VA 267's HOV lanes – see below);
- Virginia Route 267 (Dulles Toll Road), where operation of concurrent-flow HOV lanes began in December 1998, connecting to I-66 via the Dulles Connector; and,
- I-95/I-395 (Shirley Highway) in the Northern Virginia counties of Prince William, Fairfax, and Arlington, and the City of Alexandria,
- I-270 and the I-270 spur in Montgomery County, Maryland;
- U.S. 50 (John Hanson Highway) in Prince George's County, Maryland.

COG/TPB staff typically studies the performance of HOV facilities every three or four years during the AM and PM peak periods. The most recent data collected and analyzed along these five HOV corridors was in Spring, 2004 and the results can be found in the *2004 Performance of Regional High Occupancy Vehicle Facilities on Freeways in the Washington Region*⁶³. The next round of data collection and analysis was scheduled for Spring 2010. The 2004 report concluded the following trends on the entire network of HOV facilities in the region:

⁶³ *2004 Performance of Regional High Occupancy Vehicle Facilities on Freeways in the Washington Region*, September 23, 2005. <http://www.mwcog.org/uploads/committee-documents/uVtXXFg20051107163409.pdf>

- All of the HOV lanes in Spring 2004 were observed to carry more persons per lane during the HOV-restricted periods than adjacent non-HOV lanes, with the exceptions of the concurrent-flow HOV lane on U.S. 50 John Hanson Highway, where per-lane person movements were found to be approximately the same in the HOV and non-HOV lanes, and the concurrent-flow HOV lane on I-270 at Md. 187 during the P.M. peak period.
- All of the HOV lanes provide savings in travel times when compared to non-HOV alternatives, especially the barrier-separated HOV lanes in the I-95/I-395 corridor in Northern Virginia.
- There generally has been a decline in average auto occupancy on the HOV facilities in Northern Virginia, particularly in the barrier-separated lanes, due in part to the hybrid vehicle exemption.

Separate analyses on Northern Virginia's I-66 corridor and the I-95/I-395 corridor were conducted in 2005 and 2006 respectively to analyze AM peak period travel only. These analyses were conducted at the request by Northern Virginia Transportation Commission (NVTC) and was sponsored by the Virginia Department of Transportation (VDOT). The studies analyzed both auto *and* transit data; that is, they were not done solely for the purposes of studying HOV facilities. However, the analyses provide some key statistics on the operation of the I-66 and I-95/I-395 HOV facilities.

Following is a breakdown of each HOV facility in detail, with some statistics provided from the above documents.

3.3.1.2 [I-66 \[add VDOT/VDRPT Multimodal Study\]](#)

Interstate-66 was opened to traffic between the Capital Beltway (I-495) and Rosslyn, in Arlington County, in 1982. Initially the facility was restricted to HOV-4 traffic, meaning four occupants per vehicle. This was lowered to HOV-3 in late 1983 and to HOV-2 in March 1995. During the 1990s, I-66 outside the Beltway was expanded to include a concurrent-flow HOV lane to Virginia Route 234 (Business) in Prince William County just north of Manassas.

Currently the I-66 HOV corridor consists of two distinct sections. One section is between the Capitol Beltway (I-495) and Rosslyn. This segment of I-66 is restricted to HOV use only during the peak commute period of the peak direction, due to the large amount of traffic traveling inbound from Northern Virginia in the morning, and outbound from the District of Columbia in the evening. The other section, between Virginia Route 234 (Business) near Manassas and the Capitol Beltway, is a concurrent-flow lane HOV facility. The entire HOV corridor is about 27 miles in length, about 9 miles inside the Beltway and 18 miles outside the Beltway.

I-66 is a key commuting corridor, as it connects the District of Columbia with the suburbs of Virginia and beyond. Direct access to employment centers in Washington, D.C. is provided via the Theodore Roosevelt Bridge over the Potomac River. Along the I-66 corridor there are also several Metrorail stations that many commuters drive to everyday. Some of these stations contain Park-and-Ride facilities that allow commuters to drive and connect to other modes, such as rail or bus.

AM Peak Period HOV Travel in the I-66 Corridor

An analysis conducted in mid-September, 2005 by COG/TPB, in conjunction with various member agencies and organizations, collected traffic and transit data along two screen lines of I-66: an outer area screen line just outside the Capital Beltway, and an inner area screen line just outside Glebe Road in Arlington County.

The analysis compared transit, HOV, and single-occupants trips. Some key results included:

- More than 6 out of 10 inbound AM peak period travelers in Northern Virginia's I-66 corridor are using transit or multiple occupant autos and vans for their travel to or through regional core area employment sites in Northern Virginia and the District of Columbia.
- Almost 17,000 persons traveling in passenger vehicles with two or more occupants (HOV2+) for their typical weekday⁶⁴ inbound AM peak period travel across the I-66 corridor inner area screen line.
- The greatest amount of HOV2+ person travel was seen on I-66. Use of I-66's inbound lanes between 6:30AM and 9:00AM is restricted to HOV2+ person vehicles and single occupant vehicles traveling from Dulles Airport.
- The effectiveness of the I-66 HOV lanes in encouraging the use of car and vanpooling and their efficiency in moving large numbers of people per lane of roadway is clearly seen in the count data collected in this study. During the 2.5-hour time period the I-66 use restrictions are in effect, the two inbound I-66 HOV lanes carry an average of 2,800 persons per lane per hour compared to an average of just 1,200 persons per lane per hour on the seven inbound nonrestricted general purpose lanes on the other roadway facilities crossing the Glebe Road screen line in this corridor.

3.3.1.3 I-95/I-395 (Shirley Highway)

The Shirley Highway Corridor is one of the two corridors that provide direct access to the employment centers (the other is I-66). Therefore, understanding congestion on these corridors is crucial.

The HOV lanes in this corridor are entirely barrier-separated, and reversible, so they accommodate heavy AM peak period northbound traffic and operate southbound in the P.M. peak period. The HOV roadway is about 27 miles long, extending from Virginia Route 234 (Dumfries Road) near Dumfries, Prince William County to South Eads Street near the Pentagon in Arlington County. Several HOV-only ramps provide direct access to the HOV lanes from park-and-ride facilities in Prince William County.

⁶⁴ Defined as a non-holiday Tuesday, Wednesday, or Thursday on which there were no special events or major traffic incidents that would affect typical traffic patterns on these days.

The corridor is also served by the Virginia Railway Express (VRE) Fredericksburg Line. The Metrorail Blue Line terminates in the corridor at Franconia-Springfield. Numerous bus lines serve the corridor, including Metrobus, the City of Alexandria's DASH, Fairfax Connector, PRTC OmniRide and private motor coach companies serving communities in Stafford and Spotsylvania Counties and the City of Fredericksburg.

AM Peak Period HOV Travel in the I-395/I-95 Corridor

A recent COG/TPB analysis (similar to the analysis for the I-66 corridor above) was conducted on the AM peak period travel on the I-395 corridor. This study was conducted in mid-September and early October 2006, and collected traffic and transit data along an inner area screen line just outside Glebe Road.

The analysis compared transit, HOV, and single-occupants trips. Some key results included:

- Two out of every three inbound AM peak period travelers in Northern Virginia's I-95/I-395 corridor are using transit or multiple occupant autos and vans for their travel to or through regional core area employment sites in Northern Virginia and the District of Columbia.
- The multi-modal Shirley Highway facility itself carries one out of every two of the inbound AM peak period travelers in this corridor, 24,500 of them in carpools and vanpools and 7,400 in buses and 16,500 in single occupant vehicles (SOV).
- It is particularly noteworthy that during the 6:00AM to 9:00AM time period, when the Shirley Highway HOV3+ use restrictions are in effect, the two Shirley HOV3+ lanes carry an average of 5,100 persons per lane per hour. This average is about 3 and one-half times greater than the average of 1,500 persons per lane per hour found on Shirley Highway's four non-restricted general purpose lanes during this 3-hour time period.

3.3.1.4 Maryland HOV Systems

I-270 HOV Facilities

In the southbound (A.M. peak) direction, the HOV concurrent-flow lane runs from I-370 near Gaithersburg south to the Rockville Pike/Capital Beltway interchange. There is also a concurrent flow HOV lane along the southbound lanes of the I-270 Spur. Together, the A.M. peak-flow direction lanes total about 11 miles in length. The Spur is just less than 2 miles long. In the northbound (P.M. peak) direction, concurrent-flow HOV lanes exist along the entire northbound I-270 Spur, and along I-270 from its southern terminus at I-495/Md. 355 to I-370 (the same sections of the corridor having HOV lanes southbound). Additionally, there are about 7.5 miles of HOV lane between I-370 and Maryland 121 near Clarksburg.

The Metro Red Line serves the I-270 corridor from Shady Grove (I-370), continues south to Bethesda, and on to the downtown area of the District of Columbia. The Mass Transit Administration's (MTA) MARC Brunswick Line also serves several stops in this corridor, and continues south to Silver Spring and on to Union Station in the District of Columbia.

Montgomery County Ride-On serves areas in the corridor north of I-370, and MTA coach service (between Hagerstown, Frederick and Shady Grove) use the HOV lanes. Express Metrobus service operates on the HOV lanes in the corridor between Bethesda and Gaithersburg.

US 50 HOV Facilities

Concurrent-flow HOV lanes operate in the U.S. 50 (John Hanson Highway) Corridor from just west of the Md. 704 Martin Luther King Highway interchange to east of the U.S. 301/Md. 3 interchange in Bowie. Unlike all other HOV lanes in the region, these lanes are HOV-2 restricted at all times (24 hours, 7 days) in both directions.

Buses operated the Washington Metropolitan Area Transit Authority (WMATA) and the Maryland Transit Administration (MTA) run on the U.S. 50 HOV lanes. To the east, the buses serve the City of Bowie in Prince George's County, and the Annapolis and Crofton areas of Anne Arundel County. All WMATA buses terminate at the New Carrollton rail station. Some MTA buses serve the downtown area of the District of Columbia, others terminate at New Carrollton.

2004 Performance of HOV Facilities on Freeways study

Most comparisons are made with results obtained from the previous Regional HOV Facilities Monitoring reports for 1997, 1998, and 1999. Trends and changes are emphasized for the HOV restricted periods inbound and outbound.

One of the ways to assess the performance of HOV facilities, and to compare these facilities, is to measure the travel time for HOV facilities versus non-HOV, and to determine the time savings. This is what was done for the 2004 study. The results are shown in [Appendix J](#).

From the results it can be concluded that all corridors HOV routes saved time and operated at higher average speeds than parallel non-HOV routes. The time savings ranged from a total of 37 minutes on I-95/I-395, to three minutes on US 50 in the AM peak direction.

HOV facilities are designed to provide faster travel times and more predictable speeds than parallel non-HOV facilities, which was something concluded in this study. It is clear that while HOV facilities aid in improving the operation of the region's roadways, they can also influence traveler behavior and manage the demand of single-occupant travel.

3.3.2 VARIABLY PRICED LANES/SYSTEMS [TO BE UPDATED]

Variably Priced Lanes (VPLS), a demand management strategy, is the pricing of roadways to help reduce congestion and generate revenue for transportation projects. The TPB has had active interest in VPLs since June 2003 when the TPB, together with the Federal Highway Administration and the Maryland, Virginia, and District Department of Transportation, sponsored a successful one day conference on value pricing in the Washington region. After the conference, in Fall 2003, the TPB created a Task Force on Value Pricing to further examine and consider the subject.

There are currently three VPL projects in the region that are included in the Constrained Long Range Transportation Plan (CLRP):

- *The Intercountry Connector* – an 18-mile east-west highway in Montgomery County and Prince George’s County Maryland that will run between I-270 and I-95/US 1. Six VPLs are planned with express bus service connecting to Metrorail. (construction began in 2008).
- *The Northern Virginia Capital Beltway High Occupancy Toll (HOT) lane project* – Four new HOT lanes are expected to be added to a 15-mile segment of I-495. These HOT lanes will be able to be used for free by vehicles with three or more occupants, as well as transit buses and emergency response vehicles. Other vehicles, such as single-occupant vehicles (SOV) will have to pay a fee to use the lanes. This fee will be according to the time of day. The project was added to the CLRP in 2005, and completion is expected by 2013.
- *I-95/I-395 HOT lane project in Northern Virginia* – HOV facilities between Eads Street in Arlington County and just south of Dumfries will be reconfigured to HOT lanes and the lanes will be extended from 2 – 3. Completion is expected in 2010.

Over the past several years, under a grant from the Federal Highway Administration’s Value Pricing Program, the TPB Value Pricing Task Force has been evaluating a regional network of variably priced lanes in the region. The Value Pricing Pilot Program allowed extensive analysis of this large network, as well as the creation of other scenarios that apply variable pricing to some existing freeway and arterial lanes. A final report, essentially a “vision document” for the future of VPLs, was produced in February, 2008, which outlines the study of a regional network of variably priced lanes.⁶⁵

The study involved the development and evaluation of the following VPL scenarios. These scenarios outline ways that VPLs could be used in the future:

- A “Maximum Capacity” network in which two VPLs were added to each direction of the region’s freeways; one VPL was added to each direction of major arterials outside the Capital Beltway; existing High-Occupancy vehicle (HOV) lanes were converted to VPLs, and direct access/egress ramps were added at key interchanges in the VPL network.
- A “DC Restrained” scenario in which the new capacity from the “Maximum Capacity” scenario was removed from all of the bridges and other facilities in the District of Columbia, and replaced by variable pricing applied to existing freeway and selected arterial lanes.
- A “DC and Parkways Restrained” scenario in which the “DC Restrained” scenario was further restrained by applying variable pricing to the existing capacity on the region’s parkways (Baltimore Washington, George Washington Memorial, Rock Creek, Clara Barton, and Suitland).

⁶⁵ *Evaluating a Network of Variably Priced Lanes for the Washington Metropolitan Region*, National Capital Region Transportation Planning Board, February 2008.

Comparison of scenarios, cost estimates, evaluation of potential land use impacts, and impacts of pricing scenarios on different populations were examined among the various scenarios. The report states that the next phase of the scenario study may identify a set of segments in these VPL networks which could be high priorities for expanding the VPL network in the region, beyond what is currently planned in the CLRP.

Value pricing is a concept that has been implemented in cities such as London, England and Stockholm, Sweden.

While the concept of value pricing is something that has yet to be implemented in our region, it will continue to be a strategy that is closely studied and considered well into the future to manage congestion.

3.3.3 TRAFFIC MANAGEMENT

The topic of Traffic Management, including Incident Management and Intelligent Transportation Systems (ITS) is considered under the Management, Operations, and Intelligent Transportation Systems (MOITS) Policy Task Force and MOITS Technical Subcommittee. MOITS advises the TPB on traffic management matters and provides a regional forum for coordination among TPB member agencies and other stakeholders on these topics.

Investments in operations-oriented strategies have time and again shown good benefit-cost ratios and best enable transportation agencies (for both highways and transit) to provide effective incident management and good customer service, through operations centers and staffs, motorist/safety service patrols, traffic signal optimization, and supporting technologies.

In addition, the Metropolitan Transportation Operations Coordination (MATOC) program, comprising DDOT, MDOT, VDOT, and WMATA, is a regional program to enhance the availability of real-time transportation information and strengthen coordination among transportation agencies.

3.3.3.1 Incident Management

According to the Federal Highway Administration, an estimated 50% of congestion is associated with incidents such as crashes, disabled vehicles, and traffic associated with special events. If an incident disrupts traffic, it is important for congestion that normal flow resumes quickly.

Many successful incident management activities are part of the robust activities undertaken by the Washington region's transportation agencies. The region's state DOTs all pursue strategies for managing their transportation systems, including operation of 24/7 traffic management centers, roadway surveillance, service patrols, and communications interconnections among personnel and systems. All three focus on getting timely word out to the media and public on incidents. Local-level agencies also play an important role in transportation management, particular on local roads and traffic signal optimization.

Specific state-wide and regional incident management strategies include:

- ***Imaging / video for surveillance and detection*** – help detect incidents and allow emergency vehicles to arrive quickly. Also helps travelers negotiate around incidents.
 - Montgomery County operates an Advanced Transportation Management System (ATMS), with 200 surveillance cameras across the County;
 - The three state DOTs implement cameras for surveillance and detection.

- ***Service patrols*** – These specially equipped motor vehicles and trained staff help in clearing incidents off a roadway and navigating traffic safely around an incident.
 - MDOT and VDOT have deployed service patrols for a number of years. DDOT began deploying patrols in 2003.
 - Montgomery County became the region’s first local jurisdiction to deploy patrols in 2006, concentrating on major arterials rather than freeways.

- ***Road Weather Management*** – Can take the forms of information dissemination, response and treatment, surveillance and monitoring, prediction, and traffic control.
 - All three state DOTs implement road weather management systems that disseminate information, treat roadways, and monitor conditions, especially during winter snow and ice events

- ***Traffic Management Centers (TMCs)*** – These centers collect and analyze traffic data, then disseminate data to the public. Data collection includes CCTVs, cameras, and loop detectors.
 - All three state DOTs have TMCs:
 - *VDOT’s Smart Traffic Control Center in Northern Virginia* collects data from loop detectors and pavement sensors embedded in roadways to prompt and automatic incident detection which alerts the traffic control center.
 - *DDOT’s Transportation Management Center* gathers and disseminates information to the public using a network of cameras and other devices.
 - *MDOT’s Coordinated Highway Action Response Team (CHART)* collects traffic data, disseminates information to the public, and provides emergency motorist assistance.

- ***Curve Speed Warning Systems*** - use roadside detectors and electronic warning signs to warn drivers, typically those in commercial trucks and other heavy vehicles, of potentially dangerous speeds in approach to curves on highways, with the intention of preventing incidents.
 - Curve speed warning systems have been used on the Capital Beltway in Virginia and Maryland.

- ***Work zone management*** - uses traffic workers, signs, and temporary road blockers to direct and control traffic during construction activities.
 - All three state DOTs have work zone management programs to temporary implement traffic management and direct traffic. The goal is to reduce incidents by controlling the flow, speed, and direction of traffic.

- **Automated truck rollover systems** - detectors deployed on ramps to warn truck drivers if they are about to exceed their rollover threshold, thus helping to reduce incidents.
 - Automated truck rollover systems, similar to the curve speed warning systems, were implemented at the same locations on the Capital Beltway in Virginia and Maryland. This was in response to a high number of truck rollovers on the Beltway in the 1980's.
- **Adaptive Signal Control** – Coordinate management of traffic signals across a signal network, adjusting the lengths of signal phases based on prevailing traffic conditions automatically in response to traffic detected at a large number of detectors.
 - Arlington County's successful Adaptive Signal System allows traffic signals to be coordinated based on prevailing traffic conditions, which can be impacted by incidents.

Studies have shown the impact incident management activities have on reducing congestion, in particular reducing duration of incidents and reducing chances for secondary incidents. An example of this type of study is the yearly analysis of impacts of the Coordinated Highway Action Response Team (CHART) on incident management in Maryland. The focus of the report is to gauge effectiveness of CHART's availability to detect and manage incidents on major freeways and highways.

Highlights of the 2007 CHART performance evaluation report includes⁶⁶:

- Distribution of incidents and disabled vehicles
 - By day and time
 - By road and location
 - By lane blockage type
 - By blockage duration
 - By nature of incident (accident, disabled vehicle, etc.)
- Comparison of current year's data with that of previous years
- Benefits from CHART's incident management
 - Assistance to drivers
 - Potential reduction in secondary incidents
 - Estimated benefits due to efficient removal of stationary vehicles
 - Direct benefits to highway users

The CHART report includes specific statistics on the impact of Maryland State Highway Administration (SHA) patrol⁶⁷, including:

- Response time to incidents blocking three or more lanes was shortened with SHA patrol:
 - For incidents blocking three lanes, response time averaged 7 minutes with SHA patrol, compared to 18 without SHA patrol.

⁶⁶ Chang, G.L & S.M. Rochon. Performance Evaluation and Benefit Analysis for CHART in Year 2007 (final report). <http://chartinput.umd.edu/reports/chart2007final.pdf>

⁶⁷ Chang, G.L & S.M. Rochon. CHART 2007 Evaluation, Module 4: The Performance Evaluation for Year 2007, http://chartinput.umd.edu/module4_2007.htm

- For incidents blocking four or more lanes, response time averaged 6 minutes with SHA patrol, compared to 14 without SHA patrol.
- Clearance time was shortened with SHA patrol:
 - On average, clearance time averaged 17 minutes with SHA patrol, compared to 34 without SHA patrol.
 - For incidents blocking only the shoulder, clearance time averaged 14 minutes with SHA patrol, compared to 32 without SHA patrol.
 - For incidents blocking 1 lane, clearance time averaged 17 minutes with SHA patrol, compared to 30 minutes without SHA patrol.
 - For incidents blocking 2 lanes, clearance time averaged 15 minutes with SHA patrol, compared to 49 minutes without SHA patrol.
 - For incidents blocking 3 lanes, clearance time averaged 42 minutes with SHA patrol, compared to 54 minutes without SHA patrol.
 - For incidents greater than 4 lanes, clearance time averaged 15 minutes with SHA patrol, compared to 46 without SHA patrol.
- Incident duration also decreased with SHA patrol:
 - On average, duration averaged 25 minutes with SHA patrol, compared to 35 without.
 - For incidents blocking shoulder only, duration averaged 20 minutes with SHA patrol, compared to 31 without.
 - For incidents blocking one lane, duration averaged 23 minutes with SHA patrol, compared to 30 without.
 - For incidents blocking two lanes, duration averaged 37 minutes with SHA patrol, compared to 51 without.
 - For incidents blocking three lanes, duration averaged 45 minutes with SHA patrol, compared to 60 without.
 - For incidents blocking 4 lanes or more, duration lasted 51 minutes with SHA patrol, compared to 53 without.

Analysis and studies such as those conducted by CHART indicate that incident management activities do have a positive impact on congestion. Each minute of reduced duration of incidents, for example, reduces the chances of secondary incidents and has a concomitant reduction in the severity and duration of non-recurring congestion. Even a relatively simple activity such as a service patrol assisting a motorist with a flat tire, or who is out of gas, might prevent a congestion-inducing crash. Continuing enhancement and investment of incident management activities will support congestion management.

The MATOC program is undertaking a benefit-cost study and some preliminary results are currently available. The benefit-cost study looked at travelers “modified trips” - trips made at a later time, on another route, by another mode, or not made due to regional significant incidents. Benefits were estimated from reduced delay, fuel consumption, emissions (including greenhouse gases), and secondary incidents. Three case studies were conducted, two freeway incidents and one arterial incident. The study found an overall benefit/cost ratio conservatively estimated at 10 to 1. **A summary report of this study will be released soon.**

3.3.3.2 Intelligent Transportation Systems

The TPB works with the region's jurisdictions and local transportation agencies to implement various ITS technologies, from which the TPB compiles and analyzes operational management data.

ITS strategies can be defined as electronic technologies and communication devices aimed at monitoring traffic flow, detecting incidents, and providing information to the public and emergency systems on what is happening on our roadways and transit communities. Much of what is done with ITS helps in reducing non-recurring and incident-related congestion.

- ***Advanced Traveler Information Systems (ATIS)*** – A technology-based means of compiling and disseminating transportation systems information on a real-time or near-real-time basis prior to or during tripmaking.
 - Virginia operates under a statewide 511 system via telephone and the Internet.
 - The District of Columbia makes traffic information, including live traffic cameras, traffic alerts, and street closures, available on the DDOT website.
 - Maryland provides live traffic information on traffic and incidents via the CHART website.
 - WMATA provides real-time transit information on the web and on informational screens in the Metrorail stations.
- ***Advanced Traffic Signal Systems*** - The coordination of traffic signal operation in a jurisdiction, or between jurisdictions. This is important to congestion, as it reduces delay and improves travel times.
 - Arlington County has successfully deployed an adaptive signal system for a portion of its signal system.
- ***Electronic Payment Systems*** - These systems can make transit use more convenient by allowing a user to pay for bus, rail, park-and-ride lots, and other transit services with one card. Convenience an appealing factor, and helps increase transit ridership and transfers among different transit modes.
 - SmarTrip cards are used for rail and bus fares (both WMATA and local buses) and for WMATA parking facilities.
 - The region's roadway toll agencies are part of the E-ZPass consortium electronic payment system.
- ***Freeway Ramp Metering*** - Traffic signals on freeway ramps that alternate between red and green to control the flow of vehicles entering the freeway. This prevents incidents that may occur from vehicles entering the freeway too quickly, and also prevents a backup of traffic on the on-ramp.
 - Ramp meters are used inside the Capital Beltway (I-495) in Virginia.
- ***Bus Priority Systems*** - Bus priority systems are sensors used to detect approaching transit vehicles and alter signal timings to improve transit performance. For example, some systems extend the duration of green signals for public transportation vehicles when

necessary. This is important because improved transit performance, including a more precisely predicted time for bus arrivals, makes public transit a more appealing option for travelers.

- There have been three pilot deployments in the region: U.S. 1 (Fairfax County), Columbia Pike (Arlington County), and Georgia Avenue (DC). These are pilot projects intended to provide lessons learned for wider deployments.
- Montgomery County has co-located traffic management and transit dispatch which enables adjustment of signals (by the centralized signal operations center) if deemed necessary for transit.

[Add TIGER grant priority bus network information]

- **Lane Management (e.g. Variable Speed Limits)** - Variable Speed Limits are sensors used to monitor prevailing weather or traffic conditions, and message signs posting enforceable speed limits. These systems can promote the most effective use of available capacity during emergency evacuations, incidents, construction, and a variety of other traffic and/or weather conditions.
 - Lane management is used throughout the region by the three state DOTs.
- **Automated Enforcement (e.g. red light cameras)** - Still or video cameras that monitor things such as speed, ramp metering, and the running of red lights, to name a few. They are important to preventing non-recurring and incident related congestion.
 - In the Washington region, the legal ability to deploy these systems is in place in the District of Columbia and Maryland, and pending in Virginia.
- **Traffic Signal Timing** - Traffic signal timing plans adjust traffic signals during an incident, during inclement weather, or to improve transit performance. The overall objective is to reduce backups at traffic signals and to increase the level of service.
- **Reversible Lanes** - Traffic sensors and lane control signs reverse the flow of traffic and allow travel in the peak direction during rush hours. This is important to alleviating congestion that may occur in one direction during a peak hour.
- **Dynamic Routing/Scheduling** - Public transportation routing and scheduling can automatically detect a vehicle's location, and dispatching and reservation technologies can facilitate the flexibility of routing/scheduling. This can help increase the timeliness of public transportation, keep transit on schedule, which in turn increases ridership.
- **Service Coordination and Fleet Management. (e.g. buses and trains sharing real-time information)** - Monitoring and communication technologies in a vehicle that facilitate the coordination of passenger transfers between vehicles or transit systems. This is important and appealing to passengers that use more than one type of transit.
- **Probe Traffic Monitoring** - Using individual vehicles in the traffic stream to measure the time it takes them to travel between two points and also to report abnormal traffic flow caused by incidents. Tracking could be done with the use of cellular phones, and in the future with the installation of a system in the vehicle which would send information to

transportation operators. This is important to monitoring recurring and non-recurring congested locations, and travel time.

- Probe traffic monitoring has been tested in the Baltimore region under the Maryland State Highway Administration and private sector partners.
- **Variable Message Signs** – Changeable electronic signs positioned along major highways that enable timely posting of warnings or other special messages.
 - All three state DOTs operate variable message signs. Posting travel times has been under study but not yet deployed. Temporary static signage has proved successful on projects such as the Woodrow Wilson Bridge construction.

3.4 Additional System Capacity

3.4.1 DOCUMENTATION OF CONGESTION MANAGEMENT FOR ADDITIONAL SYSTEM CAPACITY

Federal regulations state that any project proposing an increase in Single-Occupant Vehicle Capacity should show that congestion management strategies have been considered. The specific language from the Federal Rule states that Transportation Management Areas (TMAs) shall provide for:

“an appropriate analysis of reasonable (including multimodal) travel demand reduction and operational management strategies for the corridor in which a project that will result in a significant increase in SOVs is proposed to be advanced with Federal Funds. If the analysis demonstrates that travel demand reduction and operational management strategies cannot fully satisfy the need for additional capacity in the corridor, and additional SOV capacity is warranted, then the congestion management process shall identify all reasonable strategies to managed the SOV facility safely and effectively.”

In the Washington region, the TPB is ensuring that all proposed SOV capacity increasing projects (except those which are exempt) show that congestion management strategies have been considered to effectively manage the additional capacity. This is being done with agencies completing a “CMP Documentation Form” when submitting a proposal for projects in the long-range plan and Transportation Improvement Program (TIP).

A sample CMP documentation form was developed to provide guidance to agencies completing these forms (**Appendix K**). Agencies completing these forms are able to cite various ongoing strategies in the region, local jurisdiction, and corridor in the vicinity of their project.

3.4.2 WHERE ADDITIONAL SYSTEM CAPACITY IS NEEDED AND HOW THE ADDITIONAL SYSTEM CAPACITY WILL BE MANAGED EFFICIENTLY

The CLRP, updated regularly, identifies where major roadway capacity expansions are planned. The TPB, through the CLRP, asks that congestion management strategies be considered for these capacity increases. In the Washington region, all proposed SOV capacity increasing projects (except those which are exempt), show that congestion management strategies have been considered to effectively manage the additional capacity. These types of strategies could be of

demand or operational management, or both, as outlined in this report. Many of these strategies are considered before any capacity-increasing project is adopted.

The CLRP, through the CMP, strongly encourages consideration and implementation of strategies such as the following to manage both existing and future additional roadway capacity:

- Transportation Demand Management (TDM) strategies, such as Commuter Connections programs.
- Traffic Operational Improvements
- Public Transportation Improvements
- Intelligent Transportation Systems technologies
- Combinations of the above strategies.

Roadway capacity increases may be needed in specific locations for a number of reasons including bottleneck removal, safety improvements, economic development, and other reasons. Managing this capacity through the CMP is key.

3.5 Project-Related Congestion Management **[To Be Updated]**

3.5.1 WOODROW WILSON BRIDGE

The Woodrow Wilson Bridge is a key connection point over the Potomac River between Alexandria, Virginia and Prince George's County, Maryland. The bridge carries the traffic of the I-95/I-495 corridor, a major highway in the Washington region. Traffic on the former bridge was one of the most significant bottlenecks and transportation issues in the Washington region. Replacing the original bridge was a primary concern, and consisted of building not one, but two parallel bridges.

The first of the two bridges opened in 2006. Congestion management strategies were implemented as programs and construction features to ensure that traffic ran smoothly on this major Washington corridor. Some of these strategies included:

- ***Bridge Bucks program*** - provides an incentive for commuters to give up driving alone and try transit or vanpooling as an alternative. Designed expressly for commuters who may be affected by construction along the 7.5-mile construction corridor, Bridge Bucks provided up to \$50 per month in bus, rail or vanpool fare for one year. Bridge bucks could be used on Metrorail, local buses such as Metrobus, MTA local buses, and Fairfax Connector, and organized vanpools.
- ***Mission Possible initiative*** – The Mission Possible initiative was launched to provide information on alternative commute options, how travelers can help clear incidents, tips for drivers, and real-time traffic information.
- ***Updated Website Information*** – A Woodrow Wilson Bridge project website kept the public informed of project phases and news, a project scrapbook, a video, and more, to keep the public informed and included in the process.
- ***Bridge Construction Features***

- Construction of the new bridge will accommodate pedestrians/bicyclists and metro rail.
- The new drawbridge will be 20 feet higher than the old bridge with a 70 foot clearance. The increased clearance will allow for seventy-percent fewer bridge openings and traffic interruptions.
- Currently, there are nearly 260 openings per year, which will be reduced to approximately 65 times per year.
- The new bridge will have twelve lanes:
 - Eight general purpose lanes, matching the number of lanes on the Beltway which will unclog the existing bottleneck;
 - Two merge/divide lanes to allow safe acceleration and deceleration of vehicles traveling between the adjacent Maryland and Virginia interchanges;
 - An express/local configuration to balance through and local traffic;
 - HOV/Express Bus/rail transit lines (these lanes will not open for normal use until connecting systems are in place on both sides of the Potomac River, and will be used for incident management and traffic during construction).

3.5.2 I-95/I-495 SPRINGFIELD INTERCHANGE

The Springfield Interchange is a heavily-traveled area where I-95, I-395, and I-495 come together. The Virginia Department of Transportation (VDOT) was especially concerned about the safety of the Springfield Interchange after a study revealed that this was the most dangerous spot on the 64-mile Capital Beltway.⁶⁸ During a two-year study the interchange logged 179 incidents. Thus, it was rebuilt for safer traveling. The Springfield Interchange project was completed in June, 2007.

VDOT created one of the nation's most ambitious Congestion Management Plans (CMP) to improve safety of the Springfield Interchange. The \$28 million CMP pays for several programs to enhance commuter options during and after construction to keep traffic moving. Some CMP strategies were to:

- Improve alternative routes around the interchange;
- Provide fire and rescue equipment and staff for emergency services along with additional police services;
- A Springfield Interchange project website, to provide travelers with up-to-date information on the project status. In addition, the website provided information on alternative commute methods, traveler information systems (such as 511 Virginia), and news releases;
- Adding additional spaces to park-and-ride lots along I-95 over the course of a few years;
- Providing a shuttle for commuters from Prince William County to the District of Columbia to avoid driving in single-occupant vehicles through the construction;
- Providing informational kiosks at various business locations along the corridor;
- Providing bus passes for Metrobus;

⁶⁸ Source: www.springfieldinterchange.com

- Funding vanpooling for commuters.

VDOT developed this CMP program by working with local governments and regional transit partners. VDOT continues to coordinate with its regional partners to monitor these services to adjust programs as necessary to meet commuter needs.

3.5.3 11TH STREET BRIDGES

During the construction phases of the DDOT 11th Street Bridges project, several congestion management approaches were considered and the following will be implemented to mitigate congestion and keep traffic moving:

- Maintain three lanes of traffic in each direction across the river;
- Provide additional transit enhancements during peak traffic periods;
- Provide traveler information systems, including low power highway advisory radio, and Intelligent Transportation Systems, including real-time message signs with alternate route suggestions;
- Provide updated freeway guide signing within the immediate project area that reflects temporary access routes during the various phases of construction. Also provide way-finding signage for freeway access points on local roads in the project study area; and event management systems, such as roving tow services.

3.5.4 SOUTH CAPITOL STREET PROJECT

South Capitol Street is located near the Washington Nationals Ballpark and is anticipated to be crowded during the baseball season for Nationals games. The South Capitol Street project aims to reduce congestion in the area through implementing several congestion management features applicable for both stadium events and everyday traffic flow through the vicinity. The South Capitol Street Draft Environmental Impact Statement (DEIS) evaluates two Build Alternatives that improve safety, multimodal mobility, accessibility and support economic development in the corridor. Both alternatives include the following:

- Traffic signal optimization;
- Modifications to intersections to improve safety and reduce accident rates;
- Improved access to bus and rail transit in the project area;
- Reconstructed, widened, and/or new sidewalks and bicycle path.

Examples of the congestion management approaches considered include:

- Bicycle lanes, racks, stations, sharing lanes, and trails;
- Special events Transportation Systems Management (TSM) including a Transportation Demand Management (TDM) Web Site (godcgo.com). Citizens can use an interactive map feature on this Web Site to determine the best way to get to an event using transit (rail and bus); carpool/vanpool, bicycle, parking, and car sharing.
- *Bridge bucks* during the South Capitol Street bridge construction.

3.5.5 NORTHERN VIRGINIA CONGESTION MANAGEMENT PROGRAM DURING CONSTRUCTION

In 2007, the Virginia Department of Transportation (VDOT) began a new program of congestion management during roadway construction. This program has been developed to address potential increase congestion resulting from a number of simultaneous large-scale roadway construction

projects. These projects include I-95/ I-395 High-Occupancy Toll (HOT) lanes project, the I-495 HOT lanes project, and the I-66 spot improvements project.

Congestion management strategies considered for these future projects will be similar to those implemented for previous projects like the Woodrow Wilson Bridge and Springfield Interchange. Previous successful strategies included public outreach, additional transit services, park-and-ride facilities, and bolstering emergency services. New strategies to be considered include study and implementation of Variable Speed Limit (VPLs) to maintain mobility and minimize motorist delay, as well as additional traffic engineering analyses looking at construction related congestion.

4. STUDIES OF CONGESTION MANAGEMENT STRATEGIES

Defining, analyzing and assessing congestion management strategies are important components of the CMP. This chapter reviews performance measures adopted by the TPB and the effectiveness of demand and operational management strategies. Several important studies of strategies are also documented in this chapter as examples.

4.1 Review of Performance Measures

4.1.1 INTRODUCTION TO PERFORMANCE MEASURES

A performance measure, or indicator, is a means to gauge and understand the usage of a transportation facility, or the characteristics of particular travelers and their trips. The performance measure/indicator may refer to a particular location or “link” of the transportation system.

Performance measures can be either quantitative or qualitative. It may refer to the experience of a traveler on a trip between a particular origin and a particular destination. It may summarize all trips or trip makers between a particular origin and destination pair. Or, it may describe the operation of one mode of transportation versus another.

Federal regulations state that the CMP should include:

“Definition of congestion management objectives and performance measures to assess the extent of congestion and support the evaluation of the effectiveness of congestion reduction and mobility enhancement strategies for the movement of people and goods.”

The fields of transportation planning have typically used mode-specific performance measures/indicators to gauge conditions on the system. These include motor-vehicle specific performance measures such as traffic volumes, capacities, and level-of-service.

4.1.2 HOW PERFORMANCE MEASURES/INDICATORS WERE SELECTED

Level of Service has generally been the most widely used performance measure in the Washington region, as can be seen in the Freeway Monitoring Program and Arterial Monitoring Program. However, there are other performance measures that are used, such as Volume/Capacity (V/C) ratio.

In 1996, the CMS Task Force undertook discussion of CMP performance measures/indicators because of the emphasis in federal CMP guidance on this issue. The efforts at the beginning of the process involved a literature search and brainstorming process. An array of possible performance measures were developed based on materials from an FHWA instructional course on CMP. The CMP Task Force worked with these draft lists, adding, deleting, and changing the performance measures to suit the needs of the Washington region. The result was a stratified list of CMP performance measures.

Early in the process, the CMS Task Force was already aware of the gap between the intermodal, locally focused performance measures/indicators available and the multi-modal, wide-area scope desired for congestion management. Other issues were raised, as well, which set the tone of the discussion. The following were taken into consideration:

- Can the particular performance measure/indicator (or the data needed to feed it) be forecast by known tools and capabilities?
- Traditional congestion indicators tended to be precise in scale, addressing a particular link or intersection on the transportation system, yet modeling or forecasting capabilities tended to be rough in scale, forecasting at best, a regional or sub-regional scale.
- The choice of performance measures may lead or bias the investigator toward only certain kinds of solutions, and eliminate others that may actually be worthy. This was a particular concern expressed by elected officials on the TPB.
- The CMP tries to have a vague, layman's term, "congestion" apply to a technical process. Congestion could be characterized by crowdedness, by delay, or by decreases in traffic speeds. Conversely, crowdedness, delay, and slowing are not all the same phenomenon not always experienced, and not always tantamount to congestion.
- Level of Service appeared to be the most promising alternative to using delay. It has been used frequently in the past, and there is a level of understanding and buy-in from regional decision makers and the public. Level-of service does have some drawbacks, including not being multi-modal. In addition, it is difficult to distinguish from the varying severities of Level of Service "F."

The solution proposed and adopted instead was to choose a whole list of indicators, and apply them where and when relevant. The CMS Task Force reviewed over 100 different performance measures in use or suggested for use by States and localities around the country. This list was then narrowed to a manageable few. Some of the major criteria used to rate the utility of prospective performance measures were the following:

- Had to be clear and understandable.
- Had to be sensitive to modes.
- Had to be sensitive to time.
- Based on readily available data.
- Can be forecast.
- Able to gauge the impact of one or more congestion management strategies.

4.1.3 SELECTED CMP PERFORMANCE MEASURES

Summary List

Following is a list of performance measures selected:⁶⁹

- *Data for Direct Assessment of Current (or future background) Conditions:*
 - Traffic volumes
 - Facility capacity
 - Speed

⁶⁹ As identified in the *CMS Work Plan for the Washington Region*, approved by the TPB on September 21, 1994.

- Vehicle density
- Vehicle classification
- Vehicle occupancy
- Transit ridership

- *Calculated performance measures/indicators for congestion assessment:*
 - Volume-to-capacity (V/C) ratio
 - Level of Service
 - Person miles of travel/vehicle miles of travel
 - Truck hours of travel
 - Person hours of delay/vehicle hours of delay
 - Modal shares
 - Safety considerations
 - Vehicle trips
 - Emissions reduction benefits

Descriptions of the Performance Measures

- *Traffic volumes* – number of vehicles crossing a certain point, usually expressed for an average weekday. This indicator would be applicable in corridors or spot locations, and of interest in the assessment of most CMP strategies.
- *Facility capacity* – Typically for highways, and expressed in terms of the number of passenger car equivalents that can pass over a certain point in an hour, given the geometric characteristics and environment of the highway.
- *Speed* – Defined as the average running speed of motor vehicles traversing a section of roadway. Speed as an indicator is applicable in corridors or spot locations, and is of interest in the assessment of most CMP strategies.
- *Vehicle density* – Described as passenger-car-equivalents per lane per mile. It is of interest for highway-oriented CMP strategies such as traffic operations and HOV facilities.
- *Vehicle classification* – Entails determining the proportion of traffic passing a given point. Can be passenger cars, trucks, buses, or other vehicle types. It is applicable to spot locations, and is of interest in the assessment of most CMP strategies.
- *Vehicle occupancy* – average number of persons per motor vehicle for a given location. It is applicable region-wide, or on a corridor or spot basis. Can be used in the comparison of corridors.
- *Transit ridership* – average daily volume of passengers on given transit lines or facilities. It is of interest in the assessment of the following CMP strategies: Transportation Demand Management (TDM), transit, congestion pricing, and growth management.
- *Volume-to-Capacity (V/C) Ratio* – ratio of demand flow rate at a given level of vehicle capacity for a roadway. Calculated from available highway data according to national standards in the Highway Capacity Manual. V/C Ratio was analyzed in the 2008-2030 Plan Performance evaluation.
- *Level of Service* – rating of the quality of service provided by a roadway under a given set of operating conditions. A roadway is classified with a letter “A” through “F” with “A”

being the least congestion and “F” being the most congested. This performance measure is currently used in the Freeway Monitoring Program.

- *Person Miles of Travel/Vehicle Miles of Travel* – sum of all miles of travel by all vehicles for a given area or facility for a given period of time, factored by the vehicle occupancy to gauge person movement.
- *Modal Shares* – indicate the apportioning of person trips among possible transportation modes: single-occupant vehicle (SOV), high-occupancy vehicle (HOV), transit, non-motorized, or other modes of transportation.
- *Safety Considerations* – include empirical or sketch planning evaluation of safety or hazard issues in a given congestion situation or in consideration of potential congestion management strategies.
- *Vehicle Trips* – number of motor vehicle trips from a given origin to a given destination, which may be stratified by mode purpose, time period, vehicle type, or other classifications.
- *Emissions Reductions Benefits* – reductions in pollution emissions based on reductions in vehicle miles of travel or vehicle trips. Currently, this performance measure is used when analyzing the TERMS for the region.

Other Performance Measures for Consideration

There are a number of performance measures that would be beneficial to congestion management, but require more research before use in the CMP. Some of these include:

- *Bicycle usage and pedestrian counts*
 - Very little data on these have been collected in the region, but would be beneficial in areas such as bicycle and pedestrian planning and growth management.
- *Number of congested intersections*
 - Will give an indication of the extent and severity of congestion. Possible sources include traffic volumes, Data Clearinghouse information, and traffic operations models.
- *Hours per day of congestion*
 - Will directly address the need to gauge the extent of congestion on the transportation system. This indicator is dependent upon having travel volumes by time of day.
- *Percent person miles of travel by congestion level*
 - Will allow comparison of the extent of congestion among CMP locations.
- *Percent delay*
 - The total delay (in minutes) divided by the designated threshold (meaning expected, ideal, or free-flow) travel time. For example, a percent delay of 25% would mean that travel time on a certain segment of the transportation system is taking 25% longer than it would be expected to under non-congested conditions.
- *Number of average duration of incidents*
 - Could be incidents, special events, infrastructure or equipment failures, or other unusual circumstances that lead to a one-time-only or occasional increase in traveler delay.
- *Truck and freight movement involvement with congestion*

- Impact of truck and freight movement on congestion. Currently the region does not have much data on hand in this area.
- *Percent of person miles of travel by transit load factor*
 - This is the transit analog of highway congestion as described by Level of Service. Load factor indicates the crowdedness of the transit vehicles, thus providing an overall indication of crowdedness on the portion of the transportation system.
- *Person volume-to-person capacity ratio*
 - Used to develop a Level of Service for transportation corridors by taking the sum of automobile and transit capacities. Levels of service are then determined with reference to volume-to-capacity standards.

[To be updated to reflect MOITS Strategic Plan performance measures]

4.2 Review of Congestion Management Strategies

4.2.1 INTRODUCTION

Federal regulations state that the CMP should include:

“Identification and evaluation of the anticipated performance and expected benefits of appropriate congestion management strategies that will contribute to the more effective use and improved safety of existing and future transportation systems based on the established performance measures. The following categories of strategies, or combinations of strategies, are some examples of what should be appropriately considered for each area:

- (i) *Demand Management measures, including growth management and congestion pricing;*
- (ii) *Traffic operational improvements;*
- (iii) *Public transportation improvements;*
- (iv) *ITS technologies as related to the regional ITS architecture; and*
- (v) *Where, necessary, additional system capacity.”⁷⁰*

To address this point, strategy long lists have been developed as a way of categorizing congestion management strategies and characterizing the current impact, or potential impact, these strategies have throughout our region.

These lists are modeled after the longstanding Transportation Emission Reduction Measure (TERM) process for air quality in the region. The TERM list was formed as a way of developing additional plan and program elements which could be utilized to mitigate emission increases.

Similarly, lists have been developed for strategies under consideration for Congestion Management. At this time the effort is proposed to be qualitative, as the congestion information

⁷⁰ §450.320(c), Metropolitan Transportation Planning, Final Rule, Federal Register, February 14, 2007 – emphasis added.

is not tied to one specific location. In addition, some strategies are regional while others are done at a more local level, and a qualitative effort better characterizes the impact they have on the region as a whole.

The following section contains background and summary information of how the Strategy Long Lists were developed.

4.2.2 DESCRIPTIONS OF STRATEGIES

The general characteristics of strategies are provided in **Tables 9 and 10**; one for demand management strategies (those that influence travel behavior) and one for operational management strategies (those strategies contributing to a more effective use of existing systems). The qualitative criteria across the top of the lists, and the methodology used to categorize each strategy as “some impact (x)”, “significant impact (xx)”, and “high impact (xxx)” are the same for both tables. The separate tables are simply for the purpose of distinguishing between the two types of strategies. A more detailed review of the strategies is provided in **Appendix L**.

Table 9: Congestion Management Process (CMP) Demand Management Strategies Criteria

		QUALITATIVE CRITERIA									
		Impacts on Congestion									
		Reduces Overall Congestion	Reduces Incident-related Congestion	Supports/Promotes Multi-modal Transportation	Regional Applicability	Local Applicability	Existing Level of Deployment	Ease of Implementation	Cost	Cost Effectiveness	Enhance Existing Programs
STRATEGY											
C.5.0 Alternative Commute Programs											
C.5.1	Carpooling	xxx	x	x	xxx	xxx	xxx	xx	x	xxx	xxx
C.5.2	Ridematching Services	xxx	x	x	xxx	xxx	xxx	xx	x	xxx	xxx
C.5.3	Vanpooling	xxx	x	x	xxx	xx	xx	xx	x	xxx	xxx
C.5.4	Telecommuting	xx	x	x	xxx	xx	xx	xxx	x	xx	xxx
C.5.5	Promote Alternate Modes	xx	x	xxx	xxx	xxx	xxx	xxx	x	xx	xxx
C.5.6	Compressed/flexible work weeks	xx	x	x	xxx	xxx	xxx	xxx	x	x	xx
C.5.7	Employer outreach/mass marketing	xx	x	xxx	xxx	xxx	xx	xx	xx	xx	xxx
C.5.8	Parking cash-out	xx	x	xxx	x	xxx	x	x	xx	xx	x
C.5.9	Alternative Commute Subsidy Program	xx	x	xxx	xxx	xx	xx	x	x	xxx	xxx
C.6.0 Managed Facilities											
C.6.1	HOV	xx	x	xxx	xxx	xx	xx	xx	xxx	xxx	xxx
C.6.2	Variably Priced Lanes (VPL)	xxx	x	xx	xxx	xx	x	x	xxx	xxx	xx
C.6.3	Cordon Pricing	xxx	x	xxx	xxx	x	x	x	xx	xxx	xx
C.6.4	Bridge Tolling	xxx	x	x	xx	xx	x	x	xxx	xx	x
C.7.0 Public Transportation Improvements											
C.7.1	Electronic Payment Systems	xx	x	xxx	xx	xx	xxx	xx	xx	xxx	xx
C.7.2	Improvements/added capacity to regional rail and bus transit	xx	xx	xxx	xx	xxx	xx	x	xxx	xxx	xx
C.7.3	Improving accessibility to multi-modal options	xx	x	xxx	xx	xxx	xx	xx	xx	xx	xxx
C.7.4	Park-and-ride lot improvements	xx	x	xx	xx	xx	xx	xx	xx	xx	xx
C.7.5	Carsharing Programs	xx	x	xxx	xxx	xxx	xx	xxx	xx	xx	xxx
C.8.0 Pedestrian, bicycle, and multi-modal improvements											
C.8.1	Improve pedestrian facilities	xx	x	xxx	xx	xxx	xx	xx	xx	xx	xxx
C.8.2	Creation of new bicycle and pedestrian lanes and facilities	xx	x	xxx	xxx	xxx	xx	xx	xx	xx	xxx
C.8.3	Addition of bicycle racks at public transit stations/stops	x	x	xx	xxx	xxx	xx	xxx	x	x	xxx
C.8.4	Bike sharing programs	xx	x	xxx	xxx	xxx	xx	xxx	xx	xx	xxx
C.9.0 Growth Management											
C.9.1	Coordination of Regional Activity Centers	xx	x	xxx	xxx	xxx	xx	x	xxx	xxx	xx
C.9.2	Implementation of TLC program (i.e. coordination of transportation and land use with local gov'ts)	xx	x	xxx	xxx	xxx	xx	xxx	x	xxx	xxx
C.9.3	"Live Near Your Work" program	xx	x	xx	xxx	xx	x	xx	x	x	xx

- 1. Some Impact (x)
- 2. Significant Impact (xx)
- 3. High Impact (xxx)

Table 10: Congestion Management Process (CMP) Operational Management Strategies Criteria

		QUALITATIVE CRITERIA									
		Impacts on Congestion									
		Reduces Overall Congestion	Reduces Incident-related Congestion	Supports/Promotes Multi-modal Transportation	Regional Applicability	Local Applicability	Existing Level of Deployment	Ease of Implementation	Cost	Cost Effectiveness	Enhance Existing Programs
STRATEGY											
C.1.0 Incident Mngt./Non-recurring											
C.1.1	Imaging/Video for surveillance and Detection	xx	xxx	xx	xxx	xxx	xx	xx	xx	xxx	xxx
C.1.2	Service patrols	xx	xxx	x	xxx	xxx	xx	xxx	xx	xxx	xxx
C.1.3	Emergency Mngt. Systems (EMS)	x	xx	x	xx	xxx	xxx	xx	xxx	xxx	xxx
C.1.4	Emergency Vehicle Preemption	x	xx	x	x	xxx	xx	xx	xx	x	xx
C.1.5	Road Weather Management	x	xxx	x	xxx	xxx	xx	xx	xx	xx	xx
C.1.6	Traffic Mngt. Centers (TMCs)	xx	xxx	xx	xxx	xx	xx	xx	xx	xxx	xxx
C.1.7	Curve Speed Warning System	xx	xx	x	x	xx	x	xx	xx	xx	x
C.1.8	Work Zone Management	xx	xxx	x	xx	xxx	xx	xx	xx	xx	xx
C.1.9	Automated truck rollover systems	x	xx	x	x	xx	xx	xx	xx	xx	xx
C.2.0 ITS Technologies											
C.2.1	Advanced Traffic Signal Systems	xxx	xx	xx	xxx	xxx	xx	xx	xxx	xxx	xxx
C.2.2	Electronic Payment Systems	xxx	x	xx	xxx	xx	xx	xx	xx	xxx	xx
C.2.3	Freeway Ramp Metering	xx	x	x	xx	xx	x	xx	xx	xx	xx
C.2.4	Bus Priority Systems	x	x	xxx	xx	xxx	x	xx	xxx	xx	xx
C.2.5	Lane Management (e.g. Variable Speed Limits)	xx	xx	x	xx	xxx	x	xx	xx	xx	xx
C.2.6	Automated Enforcement (e.g. red light cameras)	x	x	x	x	xxx	xx	xx	xx	xx	xx
C.2.7	Traffic signal timing	xxx	x	xx	xxx	xxx	xx	xxx	x	xxx	xxx
C.2.8	Reversible Lanes	xx	x	x	xx	xxx	x	x	xx	xx	xx
C.2.9	Parking Management Systems	xx	x	xx	xx	xxx	x	x	xxx	xx	xx
C.2.10	Dynamic Routing/Scheduling	xx	x	xx	xxx	xxx	x	x	xxx	xx	xx
C.2.11	Service Coordination and Fleet Mngt. (e.g. buses and trains sharing real-time information)	xx	x	xxx	xxx	xxx	x	x	xx	xx	xx
C.2.12	Probe Traffic Monitoring	xx	xxx	x	xx	xx	x	xx	xx	xxx	xx
C.3.0 Advanced Traveler Information Systems											
C.3.1	511	xx	xxx	xx	xxx	x	xx	xx	xxx	xx	xxx
C.3.2	Variable Message Signs (VMS)	xx	xxx	xx	xx	xxx	xx	xx	xx	xxx	xxx
C.3.3	xxxw ay Advisory Radio (HAR)	x	xx	x	xx	xxx	xx	xxx	xx	x	xx
C.3.4	Transit Information Systems	xx	xx	xxx	xx	xxx	xx	x	xx	xx	xxx
C.4.0 Traffic Engineering Improvements											
C.4.1	Safety Improvements	x	xxx	x	x	xxx	xx	xxx	x	xxx	xxx
C.4.2	Turn Lanes	xx	x	x	x	xxx	xx	xx	xx	xx	x
C.4.3	Roundabouts	x	xx	x	x	xxx	x	x	x	xx	xx

- 1. Some Impact (x)
- 2. Significant Impact (xx)
- 3. High Impact (xxx)

4.3 Examples of Strategies Studies

4.3.1 ANALYSIS OF TRANSPORTATION EMISSIONS REDUCTION MEASURES (TERMs)

Overview

Transportation Emission Reduction Measures (TERMs) are strategies or actions employed to offset increases in nitrogen oxide (NO_x) and volatile organic compound (VOC) emissions from mobile sources. The TPB has been adopting TERMs since FY 1995.

The Clean Air Act Amendments of 1990 (CAAA) and SAFETEA-LU requires metropolitan planning organizations and DOTs to perform air quality analyses, to ensure that the transportation plan and program conform to mobile emission budget established in the State Implementation Plans (SIP). Consequently MPOs and DOTs are required to identify TERMs that would provide emission-reduction benefits and other measures intended to modify motor vehicle use.

Selection of the TERMs requires quantitative as well as qualitative assessment. The quantitative assessment includes specific information on the benefits, costs, and expected air-quality benefits. Qualitative criteria includes ranking based on the subjective criteria's such as ease of implementation, how to implement, and synergy with other measures.

As greenhouse gas (GHG) emission becomes a global climate issue, the effects of TERMs on GHG reduction in the Washington region are analyzed in the "What Would It Take" Scenario Study (see [Section 4.3.3](#)).

Findings and Applications to Congestion Management

Most TERMs are intended to reduce either the number of vehicle trips (VT), vehicle miles traveled (VMT), or both. These strategies may include ridesharing and telecommuting programs, improved transit and bicycling facilities, clean fuel vehicle programs or other possible actions. These TERMs are not only an important to offsetting increases in NO_x and VOC, but may be important to the implications of congestion management as well.

The Washington region has adopted and implemented several TERMs with the sole aim of reducing emissions, such as the addition of clean diesel bus service, taxicabs with Compressed Natural Gas (CNG) cabs, and CNG buses. However, many TERMs also have an impact on congestion management. Examples of some of these congestion-mitigating TERMs that have been implemented include (the number after each TERM coincides with a number on the TERM tracking sheet):

- *Upgraded Signal Systems in Maryland*
 - MD 85 Executive Way to MD 355
 - MD 355, I-70 ramps to Grove Road
 - MD 410, 62nd Avenue to Riverdale Rd

- *Traffic Signal Optimization*
- *Alexandria Telecommuting Program*
- *Cherry Hill VRE access*
- *Bicycle facilities*
- *Additional park-and-ride lots*
 - *Shady Grove West park-and-ride*
 - *White Oak park-and-ride*
 - *Tacketts Mill park-and-ride*
 - *Town of Leesburg park-and-ride*
- *Pedestrian facilities to Metrorail*
- *Employer outreach/Guaranteed Ride Home*
- *District of Columbia Incident Response and Traffic Management System*
- *Carsharing program*

In addition, there are a number of potential TERMS that are being considered for the region that would impact congestion management. Some examples include:

- *Employer parking cash-out (M-07A)*
- *Improve pedestrian facilities near rail stations (M-93)*
- *Implement neighborhood circulator buses (M -134)*
- *Vanpool incentive program (M-132)*
- *WMATA bus information displays with maps (M-148)*
- *Enhanced commuter service (HOV facilities) (M-150)*
- *Parking impact fees (M-144)*

4.3.2 REGIONAL MOBILITY AND ACCESSIBILITY SCENARIO STUDY – PHASE I

Introduction

As the National Capital Region Transportation Planning Board (TPB) voted to approve the 2000 fiscally Constrained Long-Range Transportation Plan (CLRP), members were dissatisfied to learn that congestion would continue to worsen over the next 25 years. The Regional Mobility and Accessibility Study (RMAS) grew out of this dissatisfaction. It sought to find creative new options to improve future congestion and performance of the region's transportation system. High rates of population and employment growth are projected for the region over the next 25 years. This will place future travel demands that may exceed projected revenues needed for new and expanded highway and transit network facilities. The Study's stated purpose was to "evaluate alternative options to improve mobility and accessibility between and among regional activity centers and the regional core."

Five alternative land use and transportation scenarios were analyzed. These alternatives analyzed different options to enable workers in the metropolitan Washington region to live closer to regional employment activity centers interconnected to each other through a greatly expanded regional transit network. The idea is to examine alternative transportation improvements together with potential future land use changes. If regional stakeholders ultimately agree on

these options, the region could move forward in pursuing additional funding to implement the most promising of these transportation improvements and making the necessary changes in local land use plans.

The alternatives were developed by a Joint Technical Working Group (JTWG) composed of state and local jurisdiction staff serving in their role as members of the TPB Technical Committee, the Planning Directors' Technical Advisory Committee, and the Metropolitan Washington Air Quality Committee (MWAQC) Technical Advisory Committee. In addition, members of the TPB Citizen Advisory Committee and the Citizen Advisory Committees to MWAQC and the Council of Governments (COG) Metropolitan Development Policy Committee (MDPC) were also invited to participate in the meetings of the JTWG. The first phase of the study was completed in late 2006.

Strategies and Scenarios Analyzed

The following are the five strategies and scenarios analyzed:

1. *“Higher Households in Region” Scenario*: To reduce the estimate of forecast growth in the long distance commuting trips to the to the Washington region. This scenario assumed the development of more housing in the region than is currently planned for by 2030.
2. *“More Households in Inner Areas” Scenario*: To enable more workers to live closer to their jobs by assuming some shifts in future household growth from the outer suburbs of the region to the inner suburbs and core area jurisdictions.
3. *“More Jobs in Outer Areas” Scenario*: To examine the impacts of shifting some of the forecast job growth from core area jurisdictions to the outer suburbs.
4. *“Region Undivided Scenario”*: To look at the potential impacts of shifting some of the future household and job growth from the western portion of the region to the eastern portion.
5. *“Transit Oriented Development (TOD)” Scenario*: To examine the impacts of concentrating more of the region's future growth in areas that could be efficiently served by transit.

Key Findings

Each scenario was carefully analyzed. Key findings from the alternative analysis showed that concentrating more of the region's future housing growth in Regional Activity Clusters supported by an expanded regional transit network would increase transit use and daily walking and biking trips, while decreasing driving and congestion relative to current plans and growth trends. This scenario also had small, but favorable impacts on regional accessibility, land use, air quality and other measures of effectiveness evaluated in this study.

TPB staff produced a technical report and summary brochure entitled “[What if the Washington Region Grew Differently?](#)” in fall 2006, completing Phase I of the Study.

4.3.3 REGIONAL MOBILITY AND ACCESSIBILITY SCENARIO STUDY – PHASE II

The Scenario Study entered into phase II in 2007 as the TPB Scenario Task Force was formed. Since then two new scenarios, “CLRP Aspirations” and “What Would It Take”, have been developed and are currently under study.

“CLRP Aspirations” Scenario

“CLRP Aspirations” scenario is an integrated land use and transportation scenario for 2030 building on the key results of the five TPB scenarios analyzed earlier. It includes a regional high-quality bus rapid transit (BRT) network operating on an extensive network of variably priced lanes.

Some noteworthy [preliminary results](#) of this scenario study are listed below. The final report is expected to release in June 2010.

- 2.2% increase in households, yet only a 1% increase in motorized trips. This is because concentrating households in activity centers provides more bike and walk options.
- HOV use virtually unchanged, which could be attributed to large increase in transit service.
- Total VMT increase of 1.5%, but VMT per Capita decreased by nearly 1%. The VMT increase due mostly to increase in households.

“What Would It Take” Scenario

“What Would It Take?” scenario starts with specific goals for reducing greenhouse gas transportation emissions for 2030 and beyond. It assesses how such goals might be achieved through different combinations of interventions that include increasing fuel efficiency, reducing the carbon-intensity of fuel, and improving travel efficiency.

Some [draft results](#) of this scenario study include:

- Strategies analyzed to date do not achieve regional goals of reducing greenhouse gas emissions, and additional strategies can and should be analyzed.
- Goals are difficult to meet and will require emission reductions in all three categories: vehicle fleet composition and fuel efficiency, alternative fuels, and the use of vehicle fleets.
- While major reductions can come from federal energy policies, local governments can make significant reductions quickly.
- Some strategies may not have major greenhouse gas (GHG) reduction potential, but have multiple benefits worth exploring through benefit-cost analysis (e.g. the MATOC program).

The study also recommended nine potential local actions that can be implemented quickly to reduce GHG.

4.3.4 MATOC BENEFIT-COST ANALYSIS

The Metropolitan Area Transportation Operations Coordination (MATOC) Program is a joint program of VDOT, MDOT, DDOT, WMATA and TPB. It aims to provide real-time situational awareness of transportation operations in the National Capital Region (NCR), especially during emergencies and other incidents with significant impacts on travelers and on the transportation systems of the region.

A benefit-cost study has been carried out to quantify the effectiveness of this program as well as to better advise stakeholders in funding identification.

The benefit-cost study looked at travelers “modified trips” - trips made at a later time, on another route, by another mode, or not made due to regional significant incidents. Benefits were estimated from reduced delay, fuel consumption, emissions (including greenhouse gases), and secondary incidents. Three case studies were conducted, two freeway incidents and one arterial incident. The study found an overall benefit/cost ratio conservatively estimated at 10 to 1. **A summary report of this study will be released soon.**

4.3.5 MOITS STRATEGIC PLAN

The Management, Operations, and Intelligent Transportation Systems (MOITS) program of the TPB has been developing a strategic plan for the program and a [draft plan](#) has been released.

This Strategic Plan defines and promotes potential regional projects or activities for the management, operations, and application of advanced technology for the region’s transportation systems, as well as to advise member agencies on management, operations, and transportation technology deployments for meeting common regional goals and objectives.

The MOITS Strategic Plan builds upon the TPB Vision by identifying four key tactical actions toward achieving and building upon the goals, objectives, and strategies of the Vision. It identifies nine emphasis areas derived from the National ITS Architecture, seven proposed projects, three strategic efforts and a number of “best practices” for consideration by the member agencies and jurisdictions. The Plan also recommends use of a few key performance measures, including travel time index, buffer time index and planning time index, which are already used in this CMP Technical Report. The Strategic Plan concludes with seven key recommendations for the MOITS Technical Subcommittee and Program.

5. HOW RESULTS OF THE CMP ARE INTEGRATED INTO THE CLRP

According to federal regulations, the CMP should be an integrated process in the CLRP rather than a standalone product of the regional transportation planning process. This chapter clarifies this integration.

5.1 Components of the CMP Are Integrated in the CLRP

There are four major components of the CMP as described in the CLRP:

- Monitor and evaluate transportation system performance
- Define and analyze strategies
- Implement strategies and assess
- Compile project-specific congestion management information

In monitoring and evaluating transportation system performance, the TPB uses Skycomp aerial photography freeway monitoring and a number of other travel monitoring activities to support both the CMP and travel demand forecast model calibration, complementing operating agencies' own information, and illustrating locations of existing congestion. CLRP travel demand modeling forecasts, in turn, provide information on future congestion locations. This provides an overall picture of current and future congestion in the region, and helps set the stage for agencies to consider and implement CMP strategies, including those integrated into capacity-increasing roadway projects.

The CMP component of the CLRP defines and analyzes a wide range of potential demand management and operations management strategies for consideration. TPB, through its Technical Committee, Travel Management Subcommittee, Travel Forecasting Subcommittee, and other committees, reviews and considers both the locations of congestion and the potential strategies when developing the CLRP.

For planned (CLRP) or programmed (TIP) projects, cross-referencing the locations of planned or programmed improvements with the locations of congestion helps guide decision makers to prioritize areas for current and future projects and associated CMP strategies. Maps in the 2009 CLRP showed a high correlation between the locations of planned or programmed projects and locations where congestion is being experienced or is expected to occur.

Thus CLRP and TIP project selection is informed by the CMP, and implementation of CMP strategies is encouraged. The region relies particularly on non-capital congestion strategies in the Commuter Connections program of demand management activities, and the Management, Operations, and Intelligent Transportation Systems (MOITS) program of operations management strategies. Assessments of these programs are analyzed, along with regular updates of travel monitoring to look at trends and impacts, to feed back to future CLRP cycles.

The TPB also compiles information pertinent to specific projects in its CMP documentation process (form) within the annual CLRP Call for Projects. This further assures and documents

that the planning of federally-funded SOV projects has included considerations of CMP strategy alternatives and integrated components.

5.2 Demand Management in the CLRP

Demand Management aims at influencing travelers' behavior for the purpose of redistributing or reducing travel demand. Existing demand management strategies contribute to a more effective use and improved safety of existing and future transportation systems. The long-range plan takes a number of demand management strategies into consideration when planning for the region's transportation infrastructure. Such strategies include alternative commute programs, managed facilities (such as HOV facilities and variably priced lanes), public transportation improvements, pedestrian and bicycle facility improvements, and growth management (implementing transportation and land use activities). These strategies are outlined in detail in [Section 3.2](#)

In "[Call for Projects](#)" for the CLRP and TIP, for any project providing a significant increase to SOV capacity, it must be documented that the implementing agency considered all appropriate systems and demand management alternatives to the SOV capacity. A Congestion Management Documentation Form is distributed along with the Call for Projects and a special set of SOV congestion management documentation questions must be answered for any project to be included in the Plan or TIP that significantly increases the single occupant vehicle carrying capacity of a highway.

A set of projects included in the CLRP and TIP are exclusively dedicated to (and titled as) transportation demand management (TDM), such as TDM for employer outreach, TDM media program, and implement a TDM program.

Some projects included in the CLRP and TIP are revised as needed to reflect pertinent TDM study results, e.g., the I-95/395 HOV-HOT-Bus Lanes project was revised to reflect the results of the Transit/Transportation Demand Management Study conducted by the Virginia Department of Rail and Public transportation (DRPT) and the Technical Advisory Committee in the 2008 CLRP.

Finally, the TPB certifies demand management of the CMP in the overall certification of the transportation planning process in the National Capital Region. The Board finds the transportation planning process is addressing the major issues in the region and is being conducted in accordance with all applicable requirements.

5.3 Operational Management in the CLRP

Part of the CMP effort focuses on defining the existing operational management strategies that contribute to the more effective use and improved safety of existing and future transportation systems. Such strategies include incident management programs, ITS Technologies, Advanced Traveler Information Systems, and traffic engineering improvements. These strategies are outlined in detail in [Section 3.3](#).

Along with demand management strategies, operational management alternatives must also be considered when SOV capacity expanding projects are submitted to the Call for Projects of the CLRP and TIP. The considerations are documented in the Congestion Management Documentation Form.

The TPB also certifies operational management of the CMP in the overall certification of the transportation planning process in the National Capital Region.

5.4 Capacity Increases in the CLRP and Their CMP Components

Federal law and regulations list capacity increases as another possible component of operational management strategies, for consideration in cases of:

- *Elimination of bottlenecks*, where a modest increase of capacity at a critical chokepoint can relieve congestion affecting a facility or facilities well beyond the chokepoint location. Widening the ramp from I-495 Capital Beltway Outer Loop to westbound VA 267 (Dulles Toll Road) relieved miles of regularly occurring backups on the Beltway and across the American Legion Bridge.
- *Safety improvements*, where safety issues may be worsening congestion, such as at high-crash locations, mitigating the safety issues may help alleviate congestion associated with those locations.
- *Traffic operational improvements*, including adding or lengthening left turn, right turn, or merge lanes or reconfiguring the engineering design of intersections to aid traffic flow while maintaining safety.

These considerations should be included in the Congestion Management Documentation Form in the CLRP and TIP project submissions.

6. CONCLUSIONS

The 2010 CMP Technical Report hereby concludes with a summary of key findings and important recommendations from throughout the report to improve the Congestion Management Process in the Washington region.

6.1 Key Findings of the 2010 CMP Technical Report

1. 2008 (when fuel prices were at an all-time high) saw reductions in congestion compared to previous years, but congestion returned to higher levels by 2009.
 - a. Total freeway lane miles with level of service (LOS) F congestion in the AM and PM peak periods dropped by 24 percent from 2005 to 2008, almost back to 2002 levels.
 - b. Peak period mile-hours of congestion on the sample of the region's freeway system increased 14 percent in the second half of 2009 compared to the second half of 2008; all time mile-hours of congestion increased 24 percent in the same time frame.
2. Congestion varies seasonally on freeways in the region: January had the least congestion and June had the worst congestion in 2009.
3. Travel time reliability has been examined in the CMP for the first time. In line with the increase of congestion, freeway travel time reliability deteriorated 13 percent from 2008 to 2009.
4. Arterial congestion tended to become worse over the years in the PM peak period (4:00-7:00 PM), especially during the PM peak hour (5:00-6:00 PM), while kept unchanged or relieved in the PM off-peak period (1:00-4:00 PM & 7:00-8:00 PM).
5. There was a region wide modal share shift from auto driver/passenger to walk, transit, bike and other modes from 1994 to 2007/2008.
6. The transit system in the Washington region serves as a major alternative to driving alone – transit mode share is among the highest several metropolitan areas in the country.
7. The Commuter Connections program remains a vital means to assist and encourage people in the Washington region to use alternatives to the single-occupant automobile.
8. Congestion management strategies of Management, Operations, and Intelligent Transportation Systems (MOITS) provide essential ways to make most of the existing transportation facilities.
9. Introduction of variably priced lanes (VPLs) remains an effective way to provide alternatives to travelers and manage congestion.
10. The Metropolitan Area Transportation Operations Coordination (MATOC) program enhances regional coordination for regional-significant incidents and the program is cost-effective with a conservative benefit to cost ratio of 10:1.

6.2 Recommendations for the Congestion Management Process

The 2010 CMP Technical Report documents the updates of the Congestion Management Process in the Washington region from mid 2008 to early 2010. Looking forward, the report leads to several important recommendations for future improvements.

1. **Continue the Commuter Connections Program.** The Commuter Connections program is a primary key strategy for demand management in the National Capital Region and it is beneficial to have a regional approach. Meanwhile, this program reduces transportation emissions and improves air quality, as identified by the TERMS evaluations.
2. **Continue the MATOC program and agency/jurisdictional transportation management activities.** The program/activities are key strategies of operational management in the National Capital Region. It addresses non-recurring congestion, improves air quality, and is cost-effective (the ratio of benefit to cost is conservatively 10:1).
3. **Capacity increasing projects should consider variable pricing and other management strategies.** Variably priced lanes (VPLs) provide a new option to avoid congestion for travelers and an effective way to manage congestion for agencies.
4. **Encourage implementation of congestion management for major construction projects.** The CMP should examine these projects and evaluate their impacts on regional congestion. Particularly, the Northern Virginia HOT lanes and the TIGER grant supported transit improvements represent examples of operational and demand management strategies respectively that can provide important contributions to the CMP.
5. **Continue and enhance the use of continuous, probe-based congestion monitoring data.** As a complementary data source to the Skycomp aerial survey, the I-95 Corridor Coalition – INRIX – University of Maryland partnership provides the CMP an innovative and profound data source for both congestion and reliability analyses. It is expected that additional coverage in Maryland, including I-270 and freeways in Frederick County, would become available in the near future. It is also possible to have continuous, probe-based data from other valid providers. Up-to-date congestion information should be provided as needed to inform decision making.
6. **Integrate probe-based congestion monitoring data and location-fixed sensor data.** The Washington region is currently covered by both the I-95 Corridor Coalition's Vehicle Probe Project and the Federal Highway Administration's [Transportation Technology Innovation and Demonstration \(TTID\) Program](#), the latter uses location-fixed sensors for continuous highway performance monitoring. Probe-based data are superior to location-fixed sensor data in travel time and speed information but lack of traffic volume – one of the parameters location-fixed sensors do provide. A combination of the two is expected to provide more meaningful insights to the nature and causes of congestion and unreliability.

7. **Continue travel time reliability analysis.** Travel time reliability is an important issue closely related to congestion, especially non-recurring congestion. Future CMP technical reports will expand the current segment-based reliability analysis to corridor-based analysis. Travel time reliability will also be used as one of the performance measures to assess congestion management strategies.

8. **Explore the use of INRIX and other emerging data sources to produce online quarterly snapshots of regional congestion.** More frequent updates of congestion would better inform policy makings and enhance the Congestion Management Process.

APPENDICES

APPENDIX A – SIGNIFICANT CHANGES FROM 2005 TO 2008 FREEWAY AERIAL SURVEYS

Improved Conditions:

- **US 50 in Maryland** - Eastbound between I-495 and Collington Rd (Figure A1).
 - **Time period:** Evening (5:30 – 6:30 PM)
 - **Change in LOS:** The 2008 LOS data indicated mostly uncongested conditions, while the 2002 and 2005 data indicated mostly congested conditions between I-495 and Lottsford Vista Rd. The roadway showed improvement in LOS after the 2005 survey.
 - **Cause of change:** There was no evidence found in the photography (such as widening or striping changes) that seemed to explain why a short, severely congested zone such as this measured significantly better in 2008 than in 2005. An overall decrease in volume appears to have contributed to the improvement.

Figure A1: US-50 in Maryland, Eastbound between I-495 and Collington Rd (Improved)

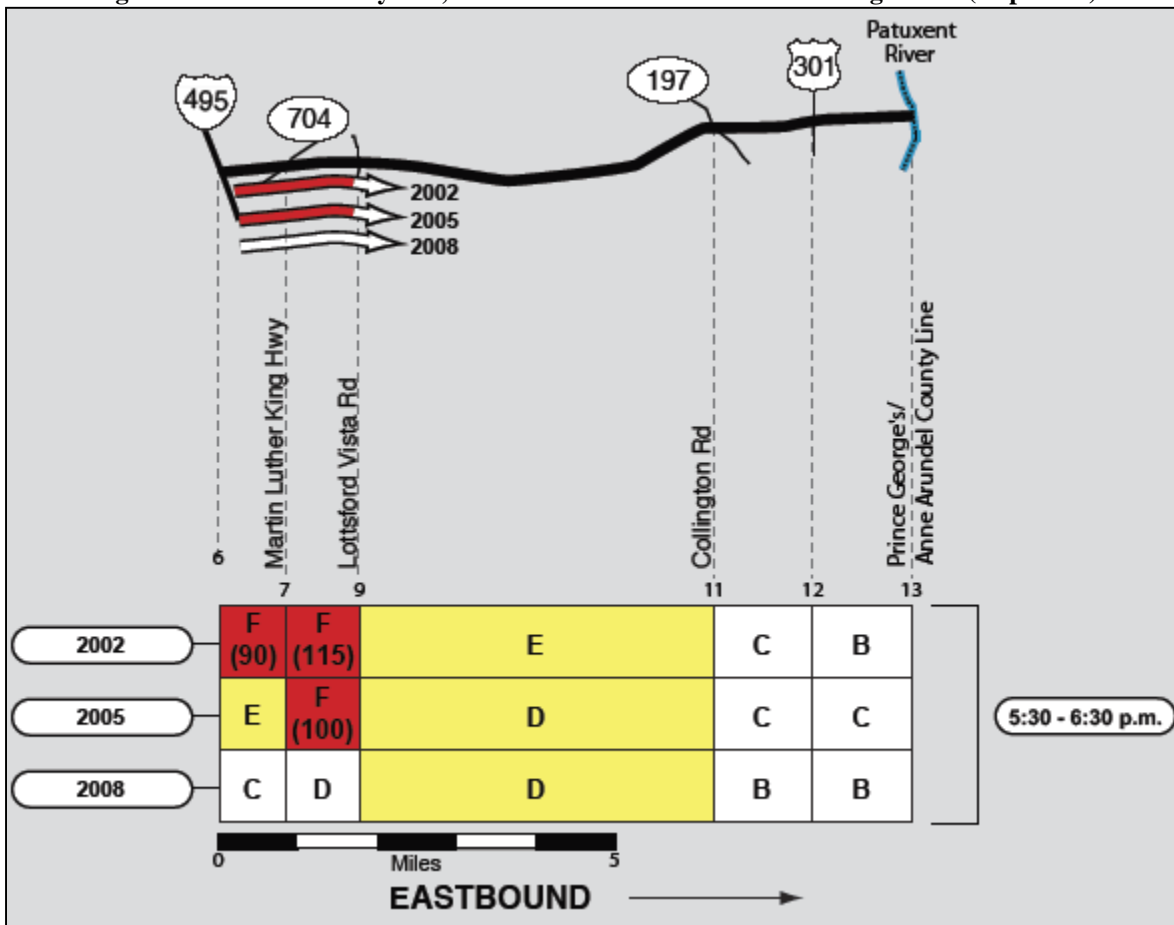

- **I-66** - Eastbound between US 15 and the Capital Beltway (Figure A2).
 - **Time period:** Morning (7:00 – 8:00 AM)
 - **Change in LOS:** The 2008 LOS data indicated less congested conditions compared to the 2005 data, especially for segments between US 15 and VA 234 bypass, and between VA 28 and VA 7100 (Fairfax County Pkwy).
 - **Cause of change:** Between 1993 and 2008, widening and HOV-lane extensions have been ongoing along I-66, while demand has been steadily increasing. The graphic below shows the degree to which the improvements have or have not kept pace with demand. Most recently, near-completion of projects west of Manassas has resulted in improved flow from the US 15 merge (Int. 40) to Prince William Pky (Int. 44). East of that point, inbound morning commuters in 2008 encountered moderate to severe congestion all of the way to the Capitol Beltway.

Figure A2: I-66 Eastbound between US 15 and the Capital Beltway (Improved)

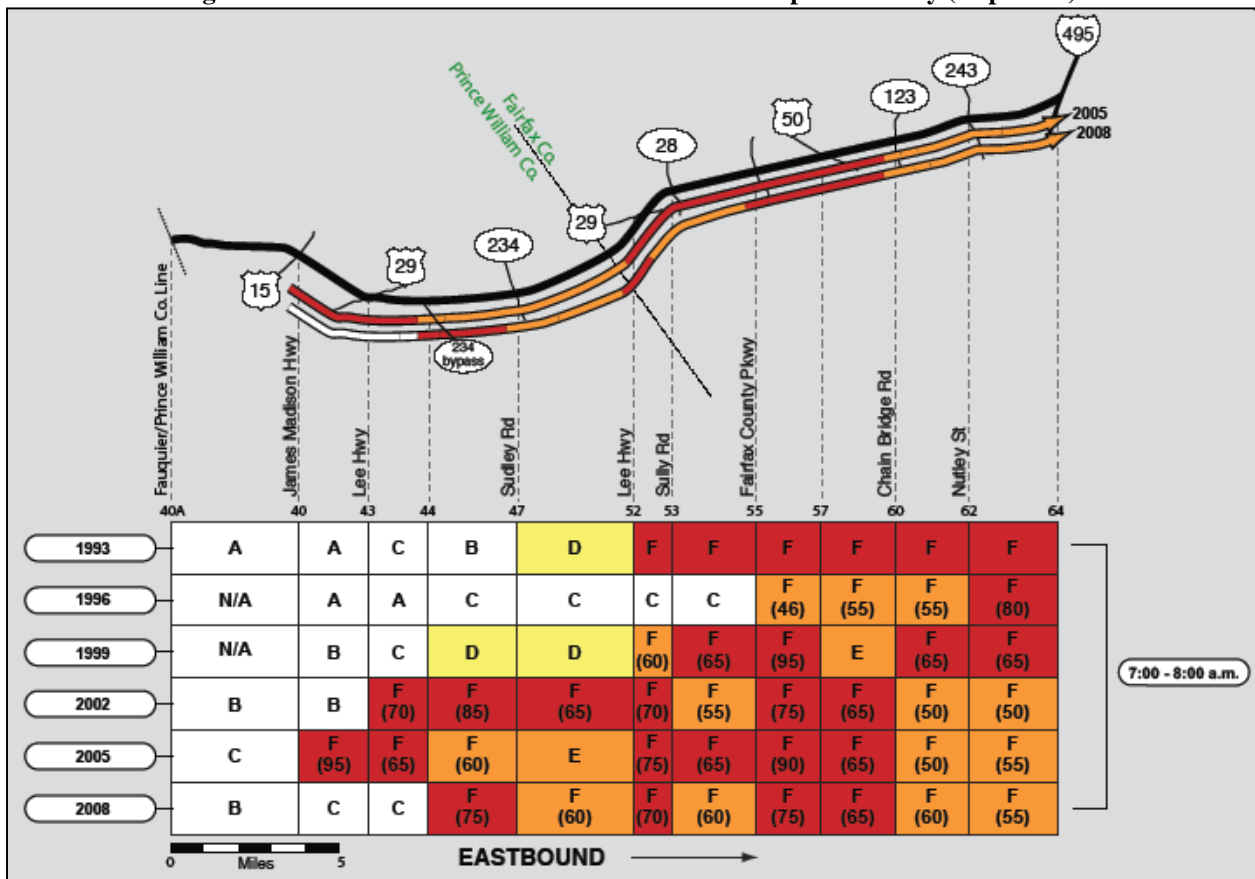

- **I-95 in Virginia - Northbound between Dale Blvd and the Capital Beltway (Figure A3).**
 - **Time period:** Morning (7:00 – 8:00 AM)
 - **Change in LOS:** During the 2008 spring survey (after completion of construction on the Springfield Interchange), the tail of the queue approaching VA 7 was found in the vicinity of Franconia Rd; Beltway-bound travelers were typically able to bypass this queue with little or no delay (the ramps from I-95 to the Beltway begin in the vicinity of Franconia Rd). Further south, improved conditions were found on I-95 between Dale Blvd and Lorton Rd (2005 vs. 2008).
 - **Cause of change:** It appeared that the completion of construction on I-95 at the Springfield Interchange and on Prince William Parkway between I-95 and US 1 may have contributed to the improved conditions; Prince William Parkway provided travelers an alternate route to US 1 and across the Occoquan River.

Figure A3: I-95 in Virginia, Northbound between Dale Blvd and the Capital Beltway (Improved)

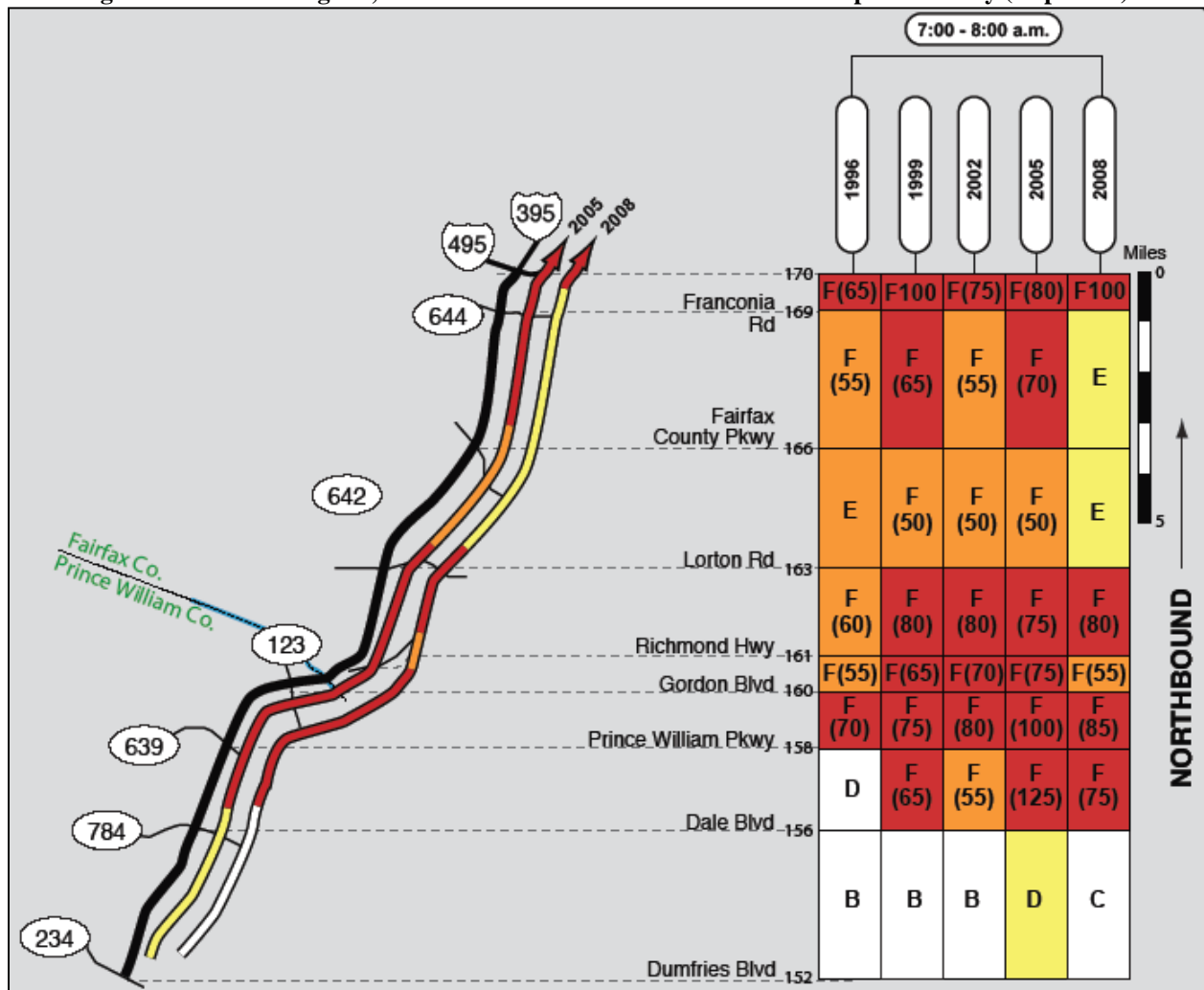

- **D.C. 295** – Northbound between Suitland Pkwy and the 11th Street Bridge (Figures A5 and A6).
 - **Time period:** Morning and Evening
 - **Change in LOS:** Between the 2005 and 2008 surveys, a simple improvement was made to the entrance ramp to I-295 from Firth Sterling Ave (this ramp carries traffic from the Suitland Pkwy), which resulted in significant traffic improvements.
 - **Cause of change:** Previously, traffic on this one-lane ramp was required to merge entirely onto the three lanes of I-295, weaving with I-295 traffic while drivers from both origins were preparing to exit to the 11th Street Bridge. The modification was to widen the entrance ramp to two lanes, and extend the acceleration lane to join it with the deceleration lane for the 11th Street Bridge. There are now four lanes between these two points, so that Suitland Parkway traffic bound for the 11th Street Bridge is no longer required to merge onto I-295. Most weaving now takes place in the 2nd lane from the right, leaving two left lanes on I-295 for through-traffic to avoid the queue to the 11th Street Bridge. The result overall has been a shorter congested zone on I-295, often with no significant delays for through-drivers.

Figure A5: Aerial Photo of the Entrance Ramp to D.C. 295 from Firth Sterling Ave



Figure A6: D.C. 295 Northbound between Suitland Pkwy and the 11th Street Bridge (Improved)

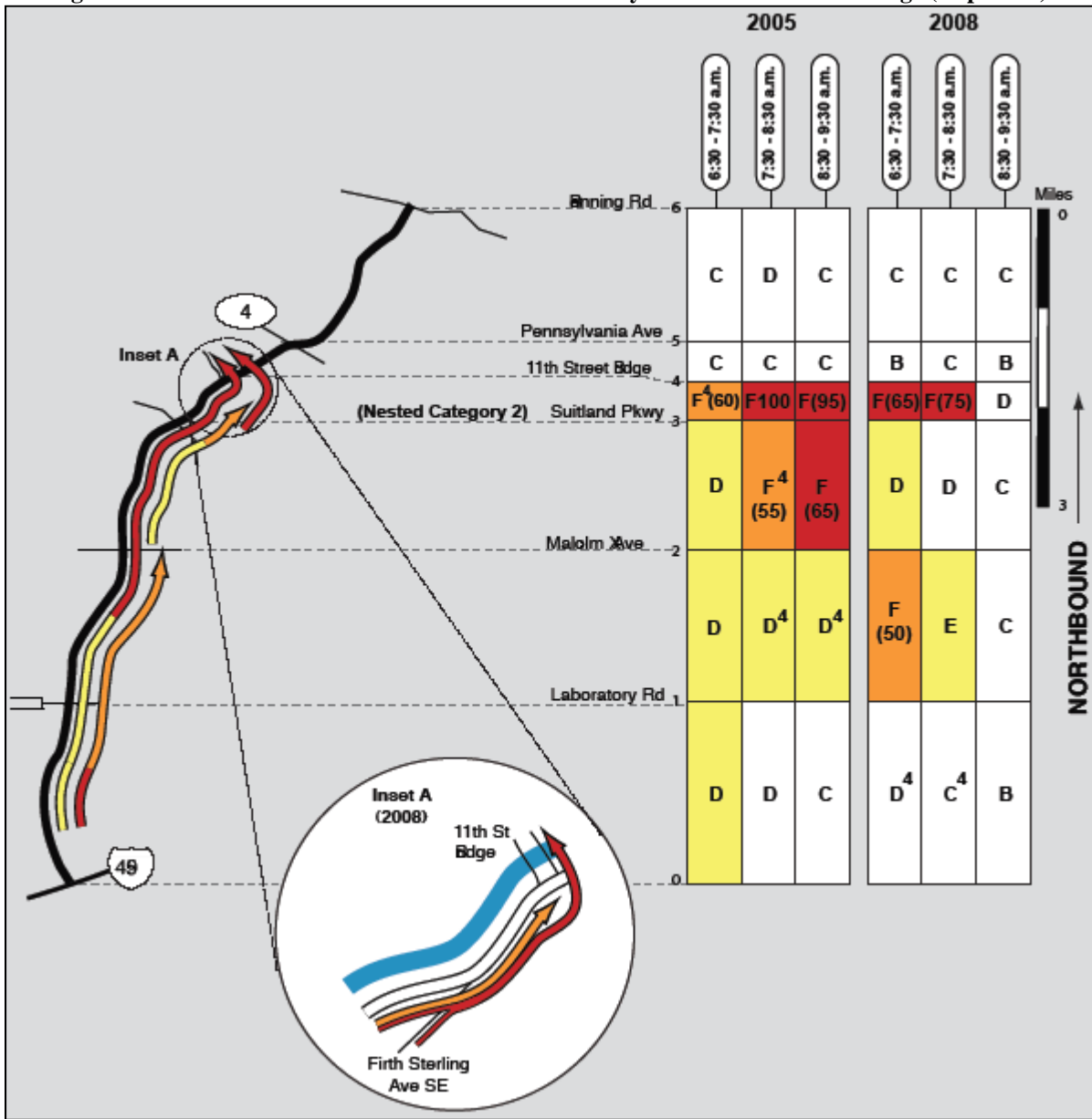

- **I-495** – Outer loop between I-270 and I-66 (Figures A7 and A8).
 - **Time period:** Morning (8:00 – 9:00 AM) and Evening (5:30 – 6:30 PM)
 - **Change in LOS:** Eight miles of severe morning congestion between the split to the I-270 spur and the exit ramp to the Dulles Toll Road was eliminated.
 - **Cause of change:** Widening in 2005 of the ramp at the Dulles Toll Road (VA 267), opened after the completion of all spring 2005 survey flights) apparently contributed to this significant change, especially between 8:00 and 9:00 a.m. Because the ramp was widened after completion of the spring 2005 survey flights, supplementary flights near the end of the year (December 2005 and January 2006) showed how the congestion on the beltway no longer formed. This finding was confirmed in 2008, with only minor delays documented (all after 8:30 a.m.) near the Georgetown Pike interchange.

Figure A7: I-495 – Outer loop between I-270 and I-66 (Improved)

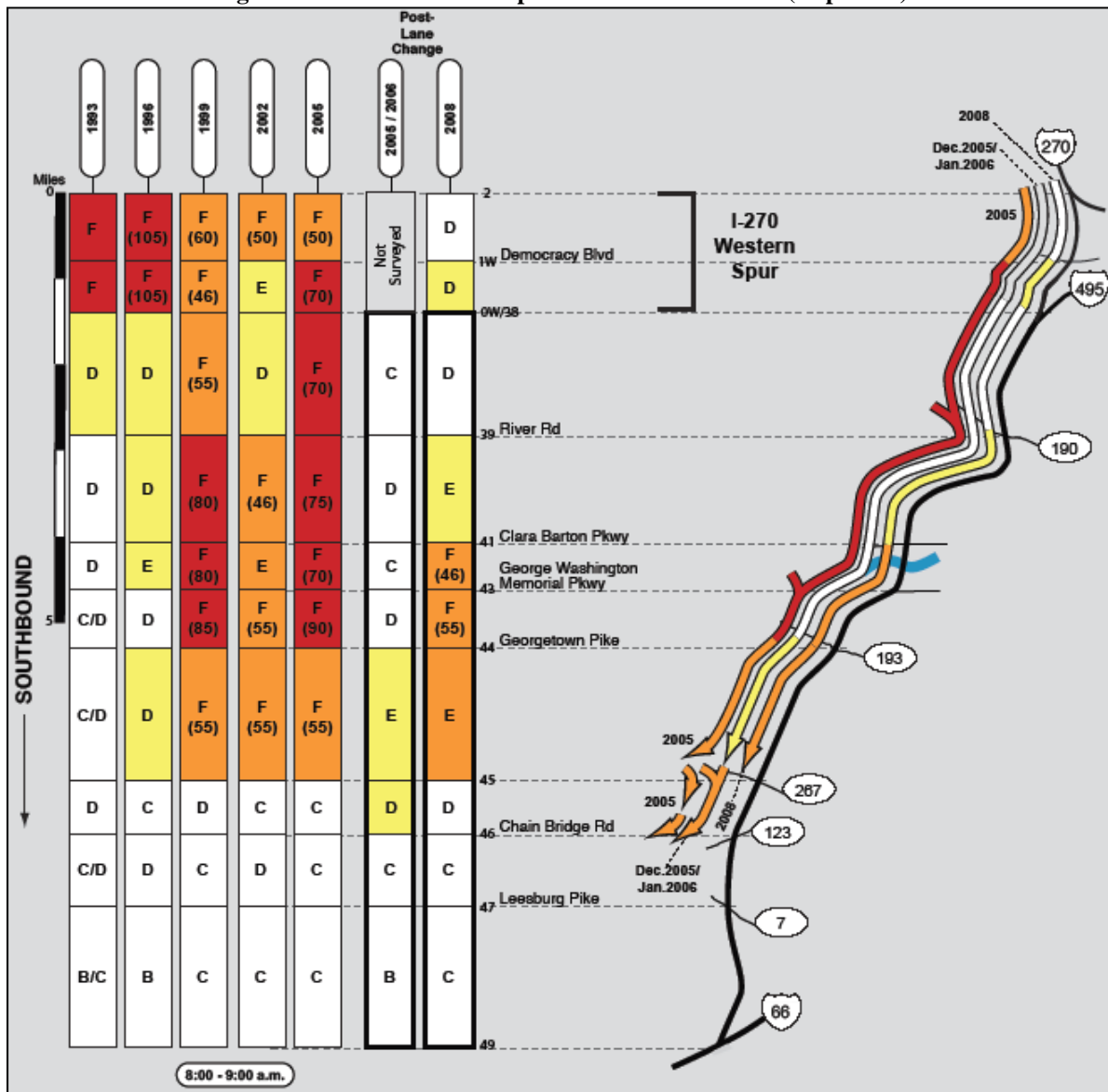
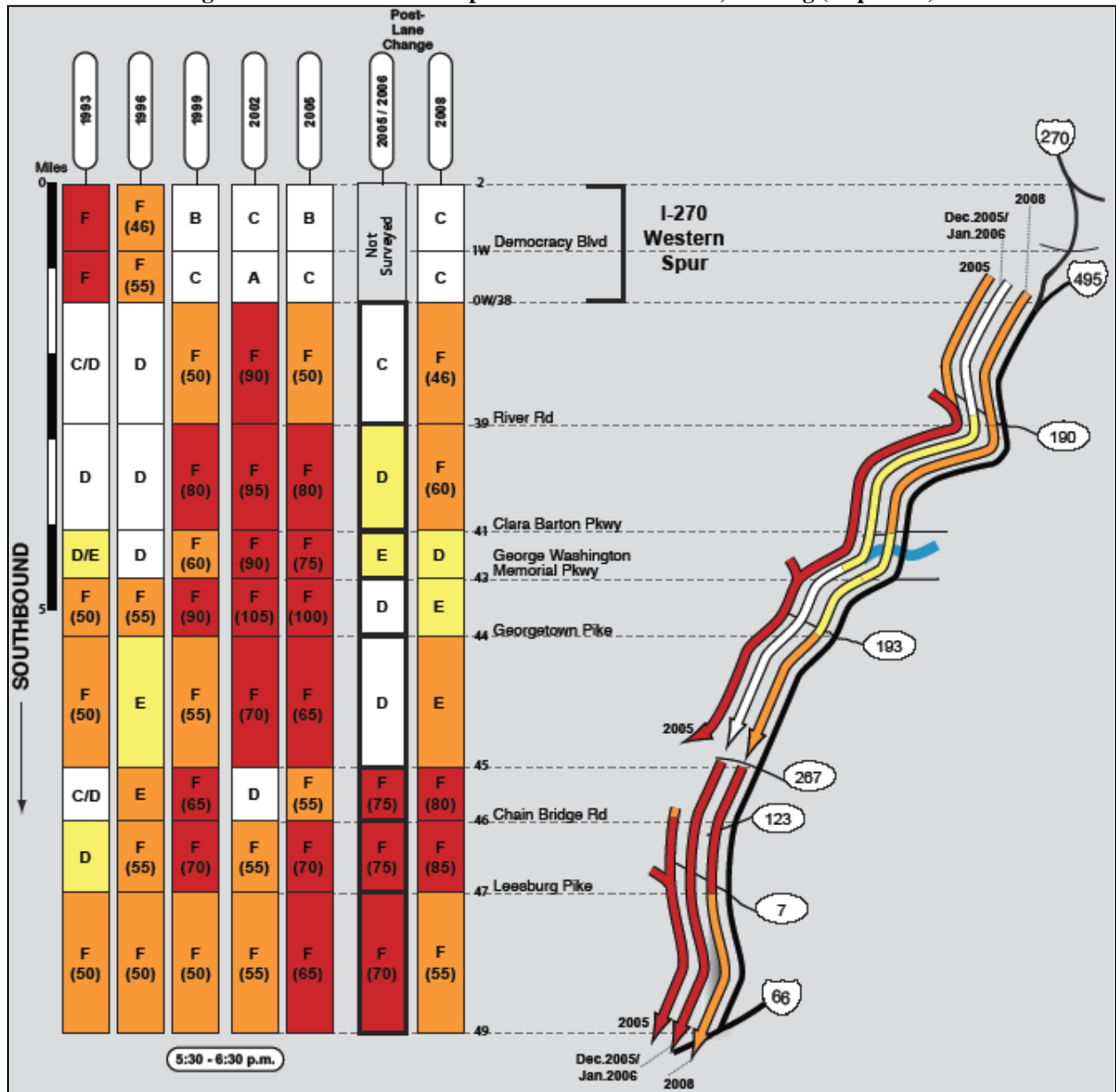

Figure A8: I-495 – Outer loop between I-270 and I-66, Evening (Improved)



Degraded Conditions:

- **US 50 in Maryland** – Westbound between US 301 and Church Rd (Figures A9).
 - **Time period:** Morning (7:00 – 8:00 AM)
 - **Change in LOS:** During the morning survey period in 2005, a new concurrent-flow HOV lane on the left eliminated congestion that had been found during the 1999 and 2002 surveys. In 2008, congestion was found here again, but only between the entrance ramp at MD 197 (Collington Rd) and the beginning of the HOV lane. While overall 2008 congestion involved relatively minor delays, evidence of a trend toward increasing congestion was found.
 - **Cause of change:** Increased demand.

Figure A9: US 50 in Maryland - Westbound between US 301 and Church Rd (Degraded)

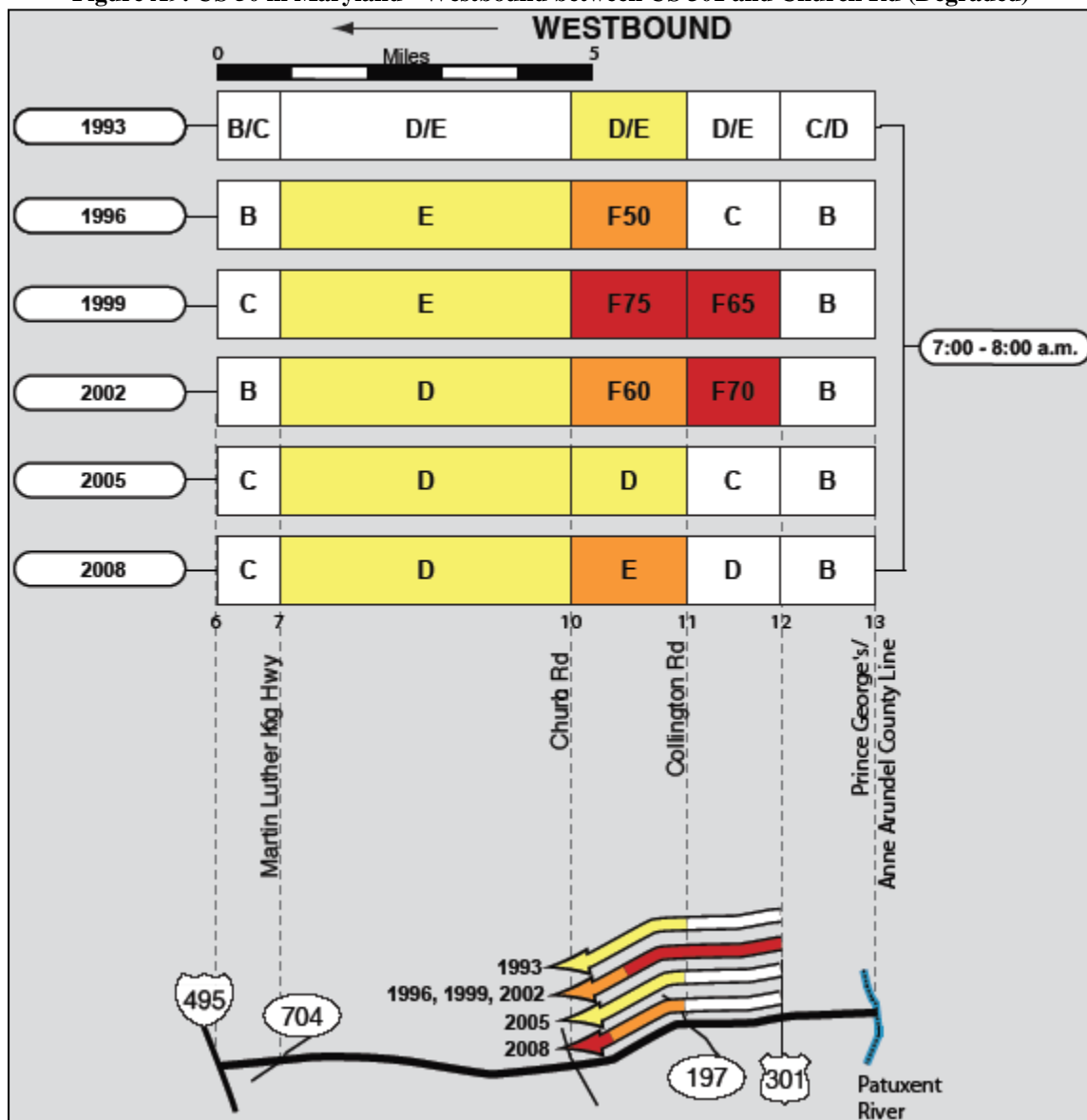

- **I-66 HOV- Eastbound** between Fairfax County Pkwy and the Capital Beltway (Figures A10).
 - **Time period:** Morning (8:00 – 9:00 AM)
 - **Change in LOS:** During the 1996 survey, severe congestion was found in the I-66 HOV lane approaching the Beltway. Between the 1996 and 1999 surveys, a dedicated HOV ramp to the outer loop of the Capital Beltway was opened; HOV users no longer were required to merge across the “general-purpose” lanes of I-66 to access the outer loop. The table below depicts the improvement in level-of-service after the construction of the ramp and the gradual degradation in conditions likely caused by increased demand since the 1999 survey.
 - **Cause of change:** Increased demand.

Figure A10: I-66 HOV Eastbound between Fairfax County Pkwy and the Capital Beltway (Degraded)

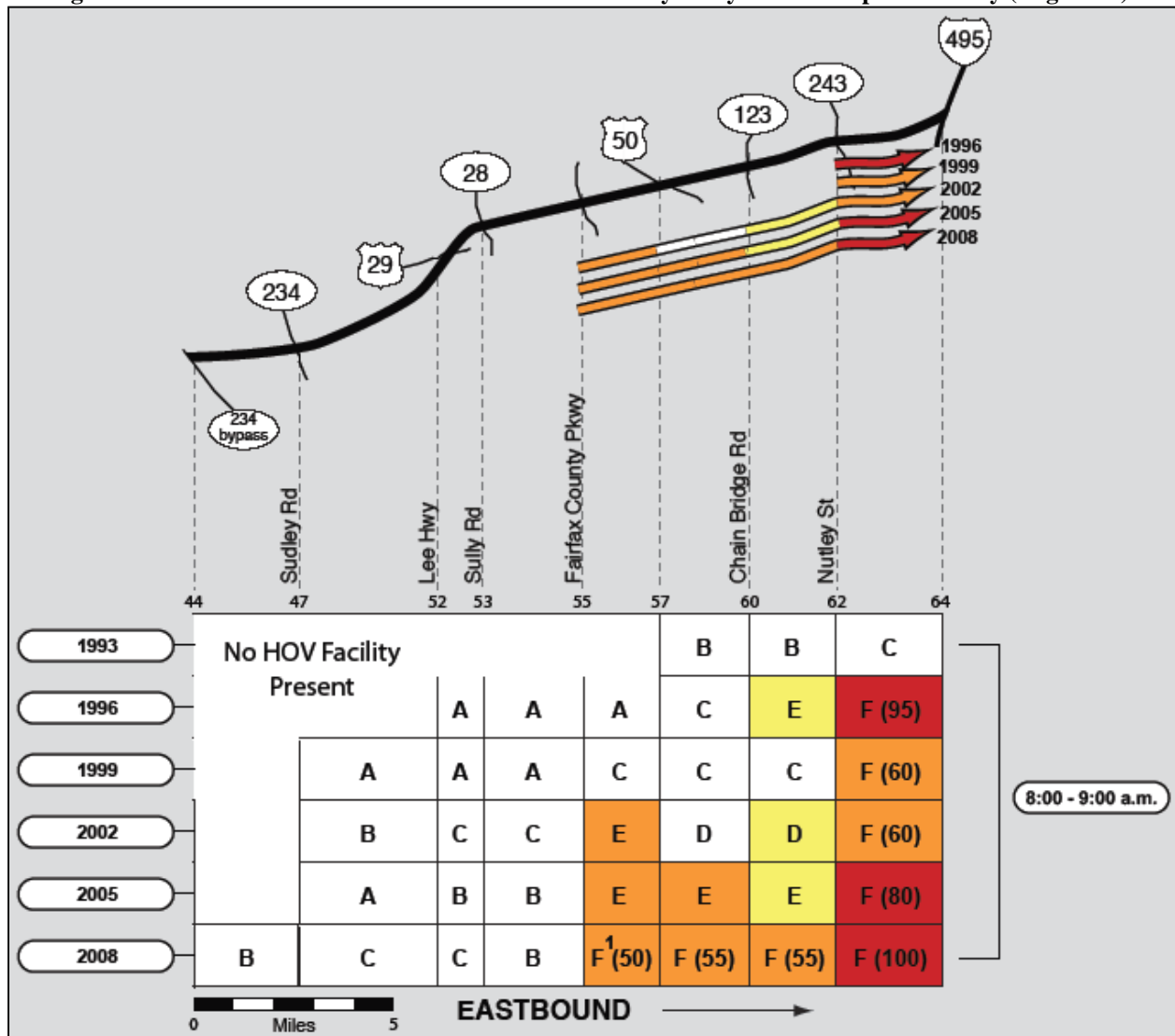

- **I-95 in Virginia** – Southbound between Dale Blvd and the Rappahannock River (Figures A11).
 - **Time period:** Evening (4:30 – 5:30 PM)
 - **Change in LOS:** The graphic below shows the continued degradation of level-of-service on I-95 between the 1996 and 2008 surveys. Congestion increased in both severity and extent between the 2005 and 2008 survey periods.
 - **Cause of change:** Increased demand.

Figure A11: I-95 in Virginia, Southbound between Dale Blvd and the Rappahannock River (Degraded)

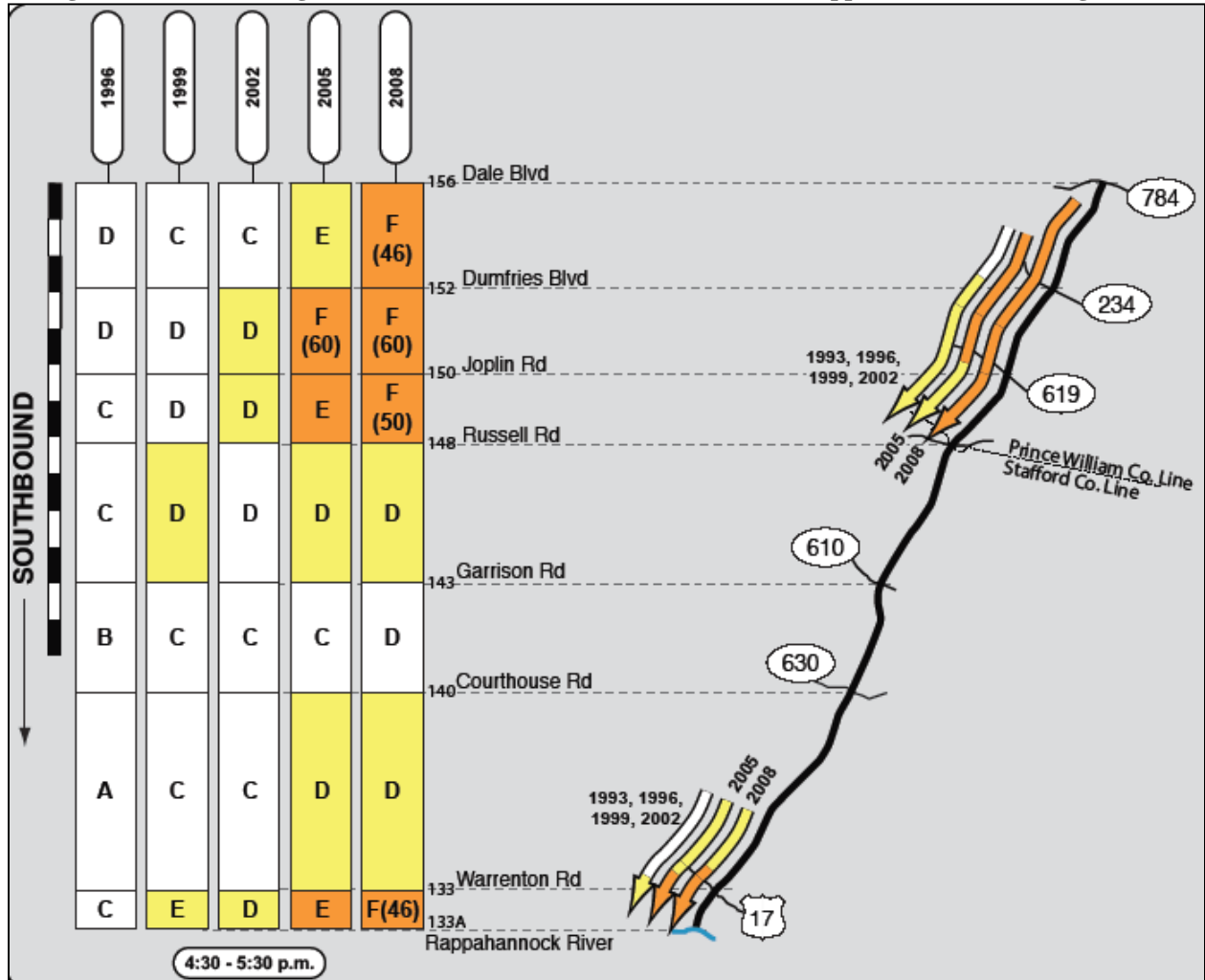

- **VA 267 HOV** – Eastbound between Fairfax County Pkwy and the Toll Plaza (Figure A13).
 - **Time period:** Morning (7:00 – 8:00 AM)
 - **Change in LOS:** The graphic below depicts level-of-service on the Dulles Toll Road HOV facility. Increased demand appears to have contributed to a gradual degradation in conditions since the facility opened prior to the 1999 survey.
 - **Cause of change:** Increased demand.

Figure A13: VA 267 HOV – Eastbound between Fairfax County Pkwy and the Toll Plaza (Degraded)

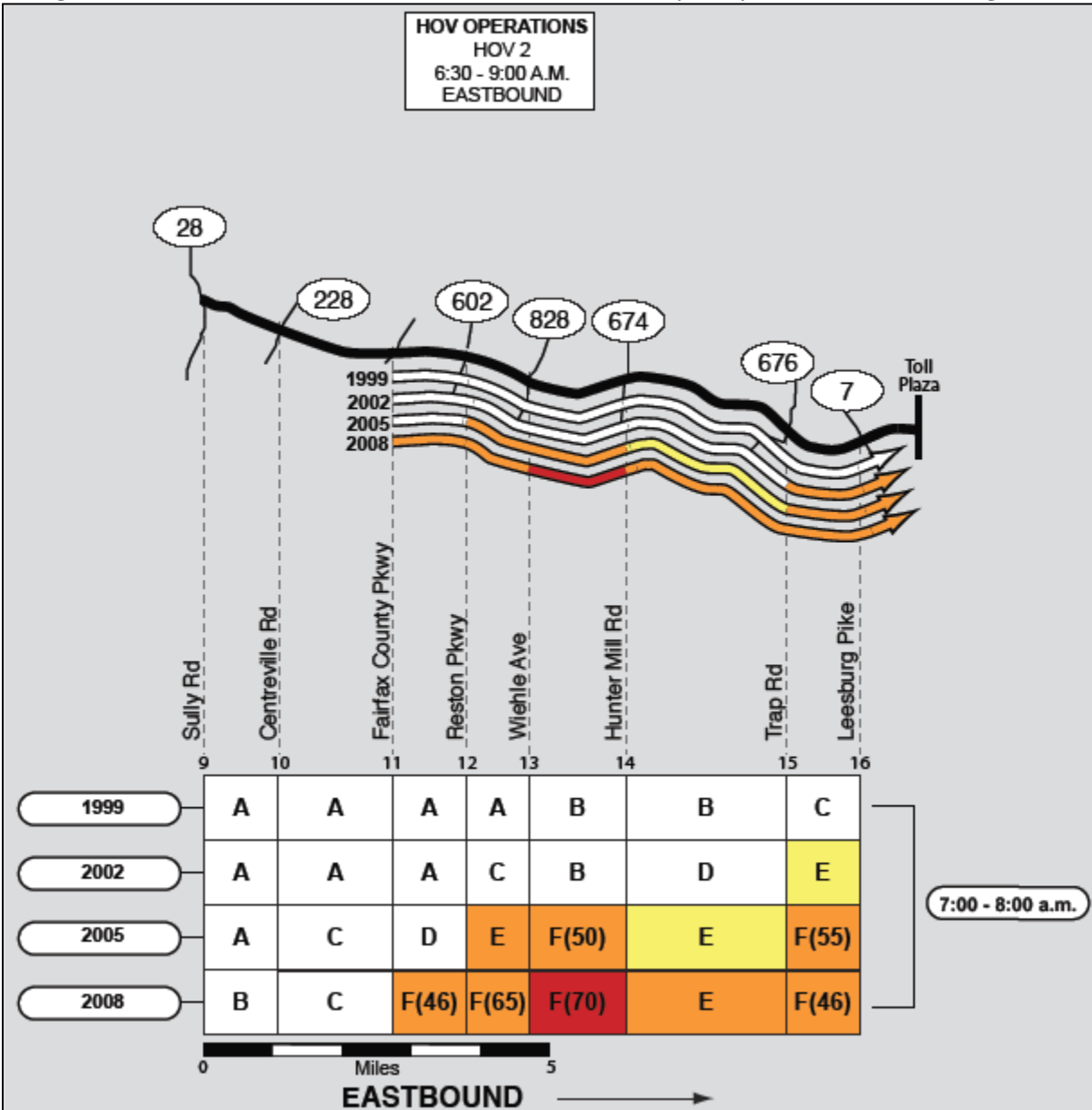

- **I-270** – Southbound between I-70 and the Capital Beltway (Figure A14).
 - **Time period:** Morning (6:00 – 9:00 AM)
 - **Change in LOS:** *Interchange (between I-70 and MD 85) - Improved:* A simple lane extension was completed between 2005 and 2008 in Frederick: previously, all traffic entering southbound I-270 from eastbound I-70 was required to merge into two lanes prior to reaching the MD 185 interchange. The change was to extend the acceleration lane for these vehicles downstream and join it with the deceleration lane to MD 85; thus, three lanes were now available for the entire length of the weave between the two interchanges. The result was to entirely eliminate a major bottleneck for I-70 drivers transitioning to southbound I-270. *Mainline – Degraded:* Farther to the south, congestion on this corridor in general seems to have shifted later in the morning period, by about 30 minutes or more (note the shift in the three-hour side-by-side performance rating tables; improvement is evident in many links between 6:00 and 8:00 a.m., while degradation is mainly evident between 8:00 and 9:00 a.m.). This could be a further effect of the major improvement of beltway flow due to the 2005 widening of the ramp at the Dulles Toll Road (VA 267), opened after the completion of all spring 2005 survey flights. In previous years, users of I-270 bound for Virginia could expect to encounter about 8 miles of severe congestion between the split to the I-270 spur and the exit ramp to the Dulles Toll Road, especially between 8:00 and 9:00 a.m. After the one lane exit ramp to VA 267 was doubled in 2005, supplementary survey flights showed how the congestion on the beltway no longer formed. This finding was confirmed in 2008, with only minor delays found (all after 8:30 a.m.) near the Georgetown Pike interchange.
 - **Cause of change:** While it might require extensive research to confirm, it is plausible that a significant number commuters now depart from home later, confident that, once they clear the MD 28 interchange, the travel time to the beltway interchanges near Tysons Corner is normally around 15 minutes.

Figure A14: I-270 – Southbound between I-70 and the Capital Beltway (Degraded)

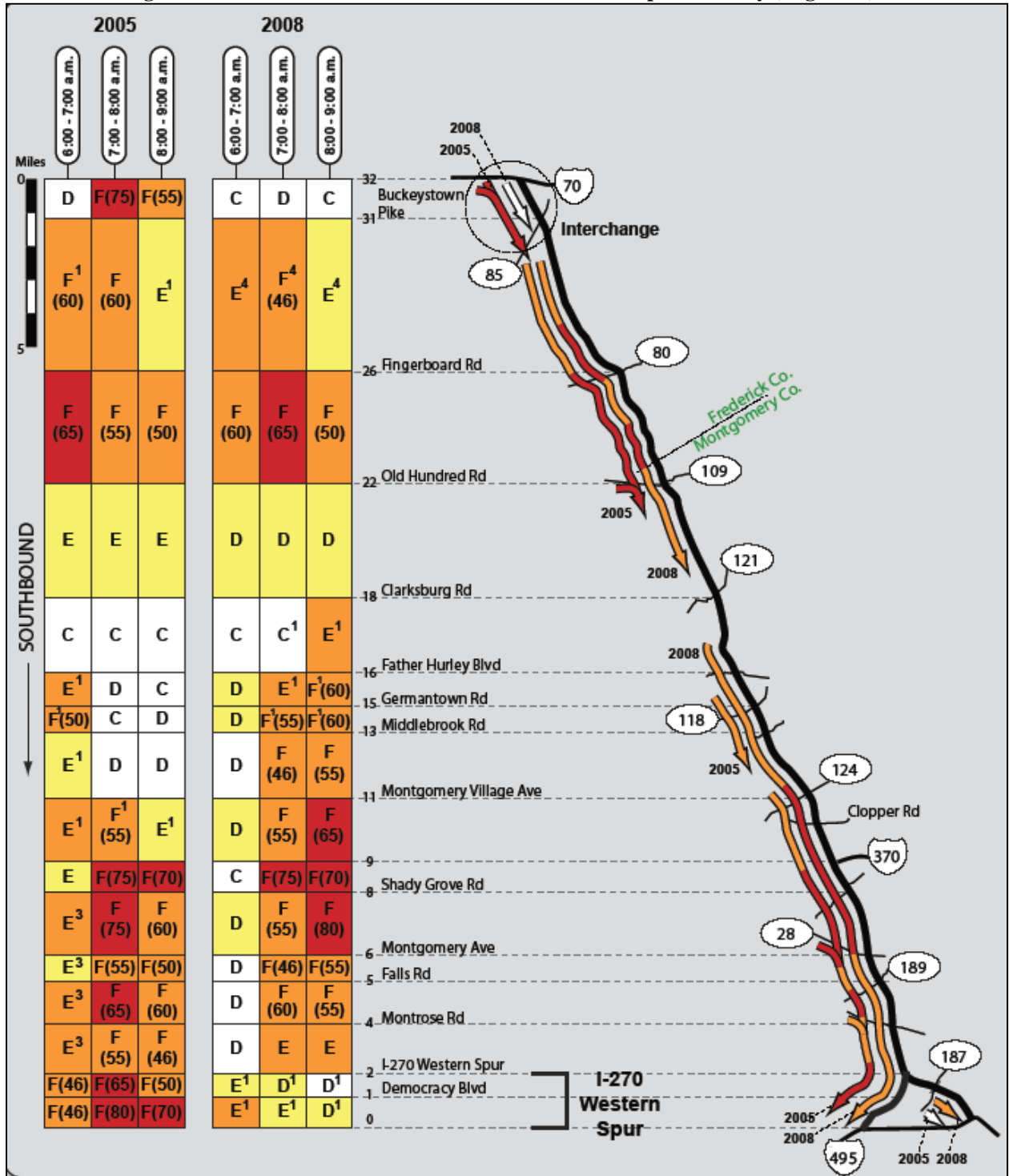

APPENDIX B – RESULTS OF FY 2008 AND FY 2009 ARTERIAL STUDIES

FY 2008 Study

The FY 2008 study⁷¹ was conducted between early December 2007 and the mid of April 2008. This study surveyed 122.9 centerline miles of arterial highways during the PM period of which approximately 43.7, 59.5, and 19.7 miles of arterial highways consisting of 20 tours were studied in Maryland, Virginia and the District of Columbia, respectively. The routes and limits of this study are listed in **Table B1** and a summary of LOS by time period and by direction is presented in **Table B2**. The LOS results are also mapped in **Figures B1 through B9** for peak hour (5:00-6:00 PM), peak period (4:00-7:00 PM) and off-peak period (1:00-4:00 PM & 7:00-8:00 PM) respectively.

Table B1: Routes and Limits (FY 2008)

Jurisdiction	Route	Route Limits		Distance (miles)
		From	To	
MD	Georgia Avenue – Segment 1	Eastern Ave	University Blvd	4.3
	Georgia Avenue – Segment 2	University Blvd	MD Route 28	5.2
	MD Route 5	Suitland Pkwy	Accokeek Rd	11.9
	MD Route 28	Viers Mill Rd	New Hampshire Ave	9.0
	MD 193 (University Blvd)	Connecticut Ave	US 29	4.2
	Randolph Rd	MD 355	Columbia Pike	9.1
MD Total				43.7
VA	Fairfax Co. Pkwy – Segment 1	Sunrise Valley Rd	Lee Hwy	7.2
	Fairfax Co. Pkwy – Segment 1	Lee Hwy	Rolling Rd	12.5
	US 1 – Segment 1	20 th St	Boswell Ave	8.1
	US 1 – Segment 2	Boswell Ave	VA Route 123	10.7
	US 29 – Segment 1	M St NW	Park Rd	7.9
	US 29 – Segment 2	Park Rd	Village Dr	6.5
	US 29 – Segment 3	Village Dr	Bull Run PO	6.6
VA Total				59.5
DC	14 Street NW	Independence Ave	K Street NW	1.0
	16th Street	K Street NW	Eastern Ave	6.1
	Connecticut Ave NW	K Street NW	Nebraska Ave	4.0
	K Street NW / New York Ave	21st Street NW	Bladensburg Rd	4.2
	Military Rd / Nebraska Ave	Connecticut Ave	Georgia Ave	2.5
	Pennsylvania Ave NW	Constitution Ave	15th Street NW	0.8
	L Street NW	Pennsylvania Ave	14th Street NW	1.1
DC Total				19.7
Regional				122.9

⁷¹ *Arterial Highway System Performance in the Metropolitan Washington Region (FY 2008)*, Presentation to the Travel Forecasting Subcommittee meeting 2008-07-18. <http://www.mwcog.org/uploads/committee-documents/Z15eWV1W20080722074840.pdf>

Total		
--------------	--	--

Table B2: LOS by Time Period and by Direction (FY 2008)

Jurisdiction	Route	LOS (Peak Hour)		LOS (Off-Peak Period)		LOS (Peak Period)	
		North/ Eastbound	South/ Westbound	North/ Eastbound	South/ Westbound	North/ Eastbound	South/ Westbound
MD	Georgia Avenue – Segment 1	F	E	E	D	E	E
	Georgia Avenue – Segment 2	E	D	D	C	E	D
	MD Route 5	A	C	A	A	A	C
	MD Route 28	C	A	A	A	B	B
	MD 193 (University Blvd)	D	C	C	C	D	C
	Randolph Rd	D	D	C	C	D	C
VA	Fairfax Co. Pkwy – Segment 1	D	F	C	D	C	F
	Fairfax Co. Pkwy – Segment 1	A	B	A	A	A	B
	US 1 – Segment 1	D	E	D	D	D	E
	US 1 – Segment 2	C	D	B	B	C	D
	US 29 – Segment 1	F	E	E	D	F	E
	US 29 – Segment 2	E	F	D	E	E	F
	US 29 – Segment 3	E	E	D	D	E	D
DC	14 Street NW	D	F	C	C	D	E
	16th Street	C	C	B	C	C	C
	Connecticut Ave NW	C	E	D	D	C	E
	K Street NW / New York Ave	F	E	E	D	F	E
	Military Rd / Nebraska Ave	C	C	C	C	C	C
	Pennsylvania Ave NW	D	D	D	D	D	E
	L Street NW	E	-	E	-	E	-

Figure B1: PM Peak Hour LOS for Surveyed Arterials in DC (5:00-6:00 PM, FY 2008)

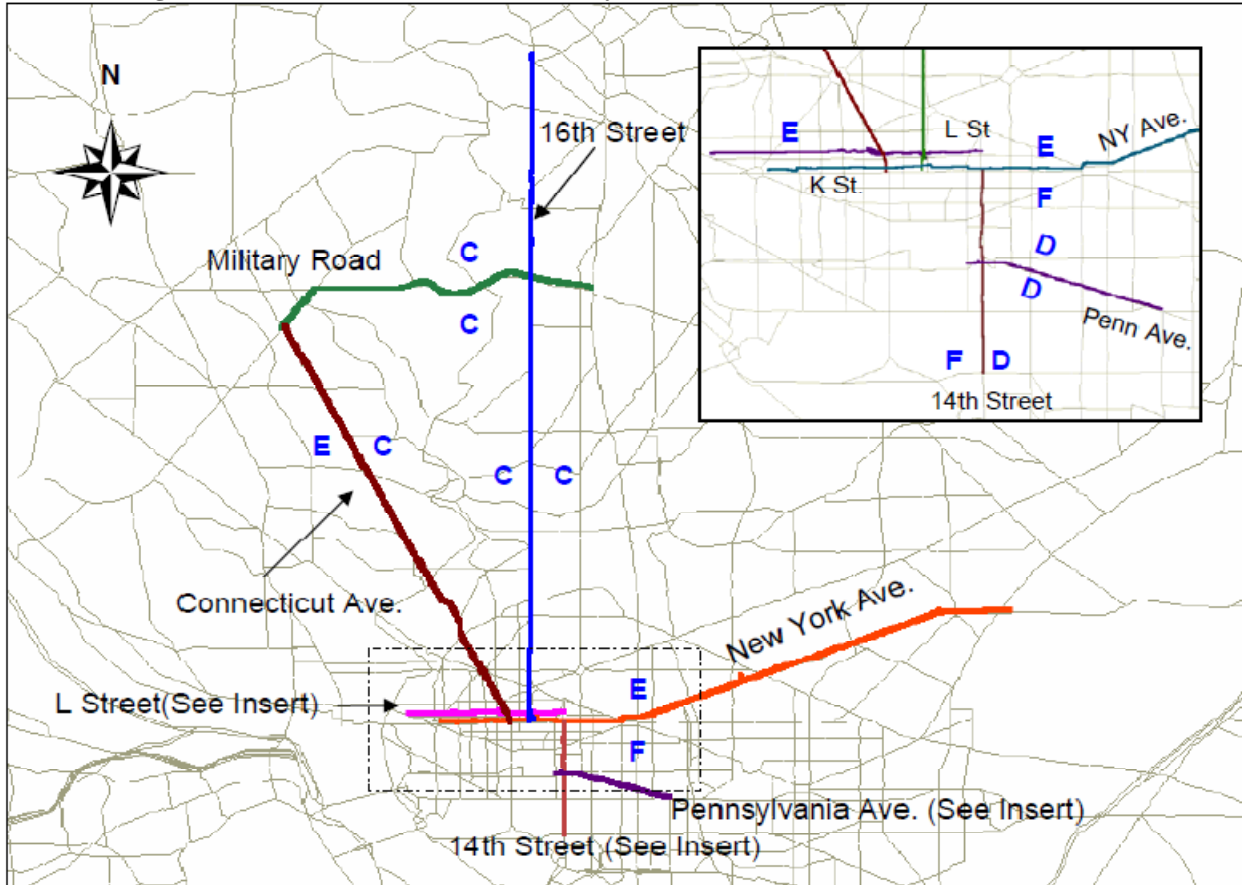

Figure B2: PM Peak Period LOS for Surveyed Arterials in DC (4:00-7:00 PM, FY 2008)

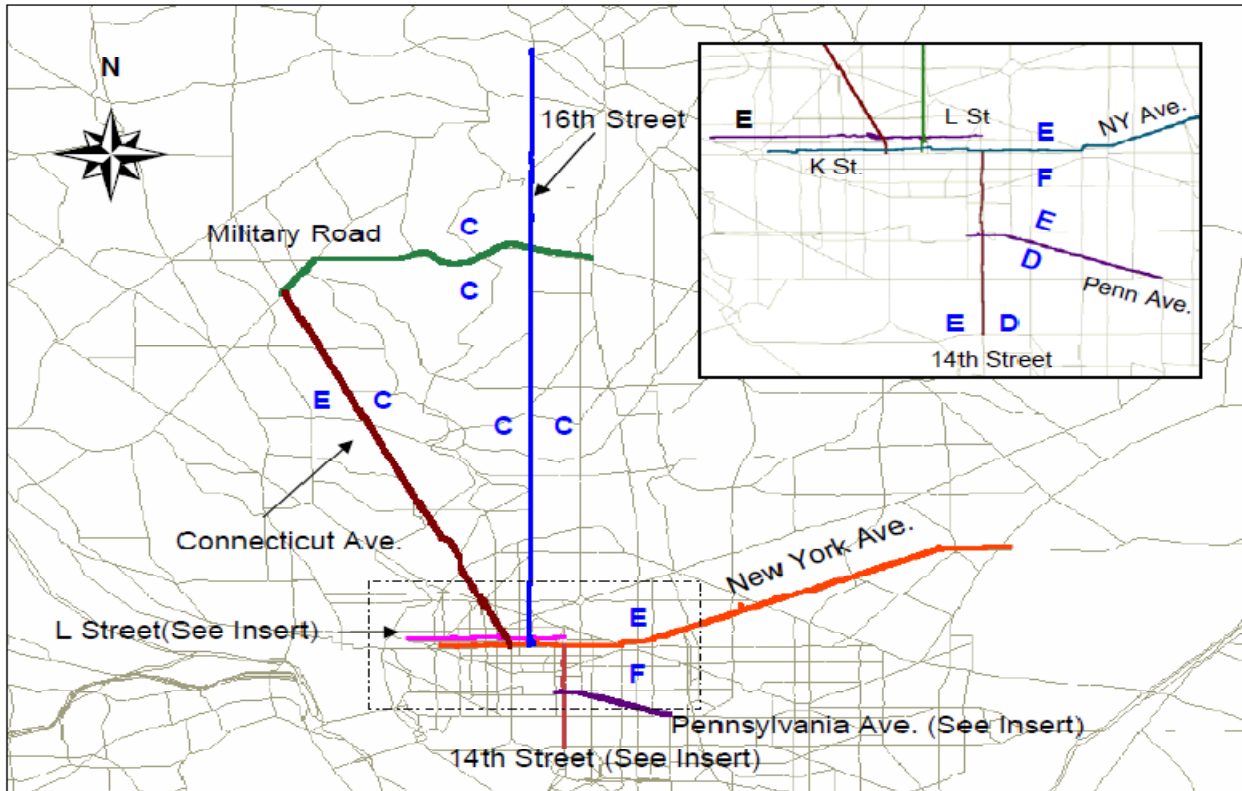

Figure B3: PM Off-Peak Period LOS for Surveyed Arterials in DC (1:00-4:00 PM & 7:00-8:00 PM, FY 2008)

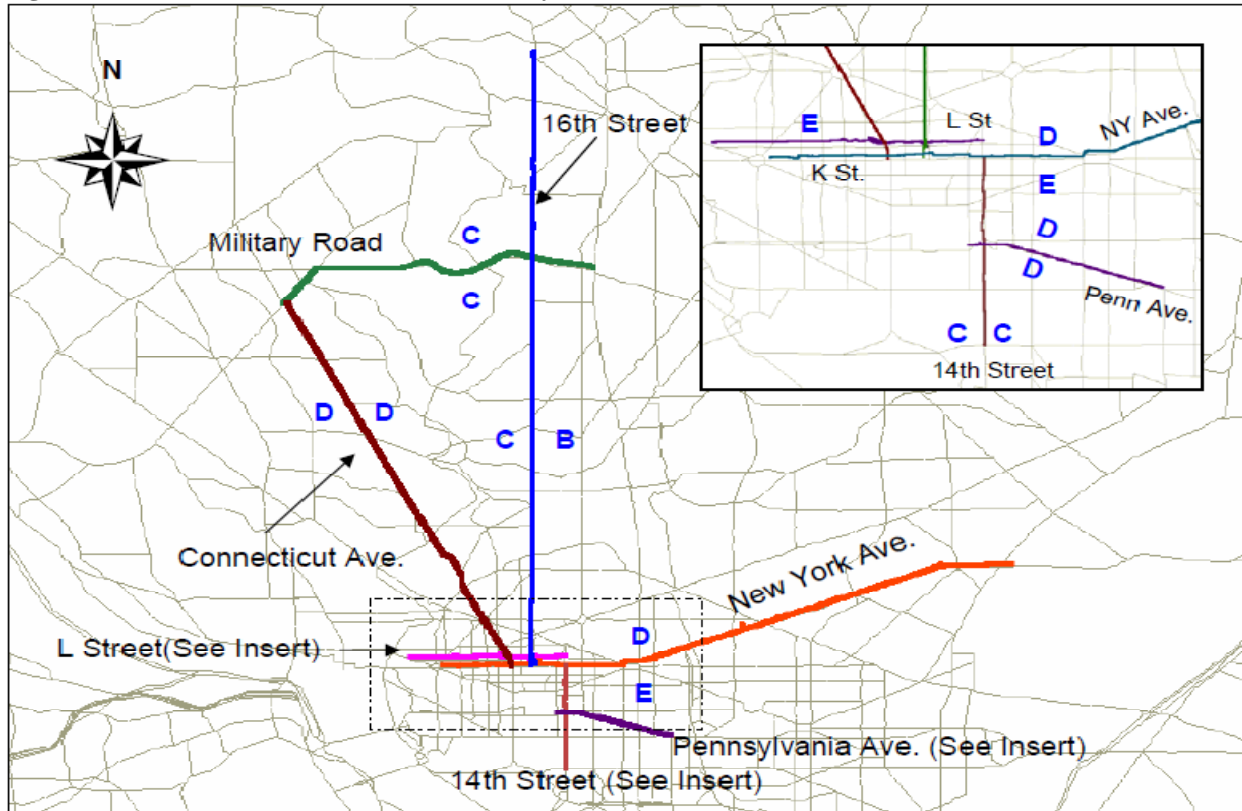

Figure B6: PM Off-Peak Period LOS for Surveyed Arterials in MD (1:00-4:00 PM & 7:00-8:00 PM, FY 2008)

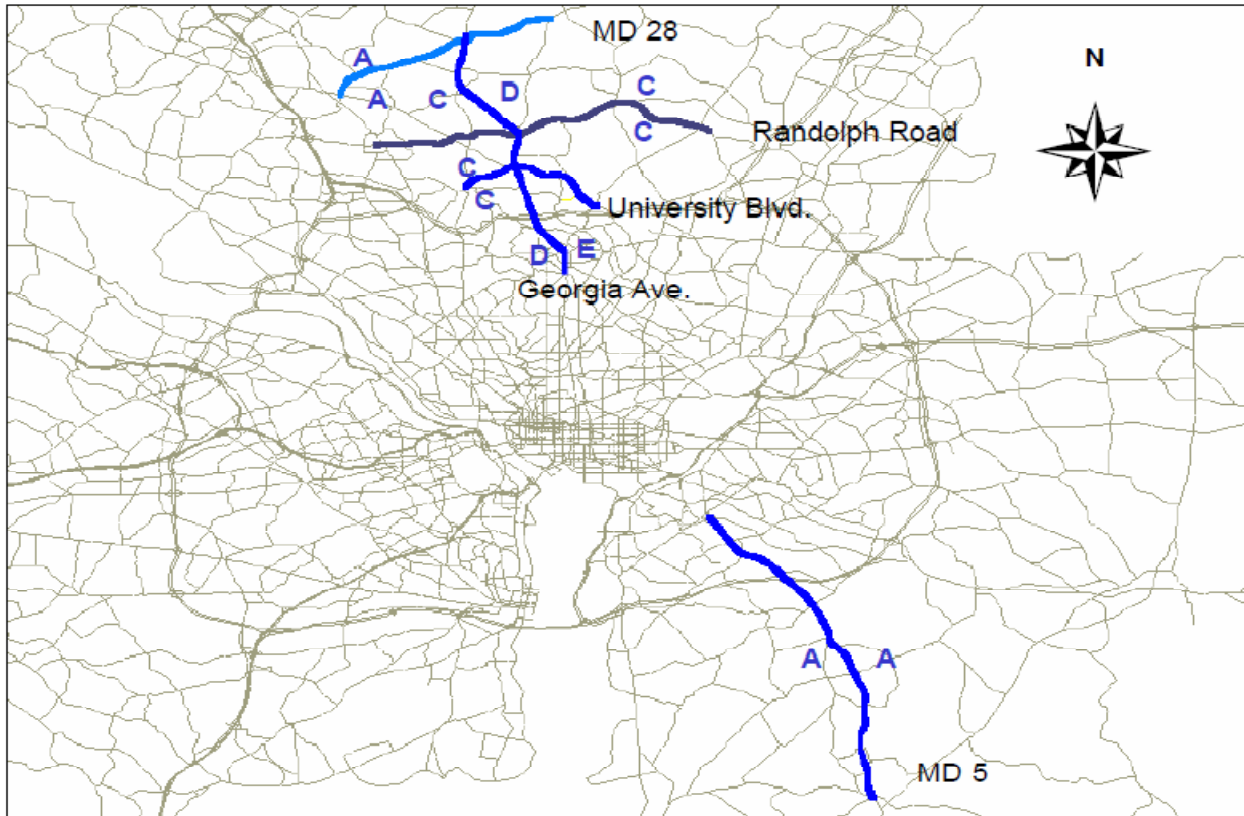

Figure B7: PM Peak Hour LOS for Surveyed Arterials in VA (5:00-6:00 PM, FY 2008)

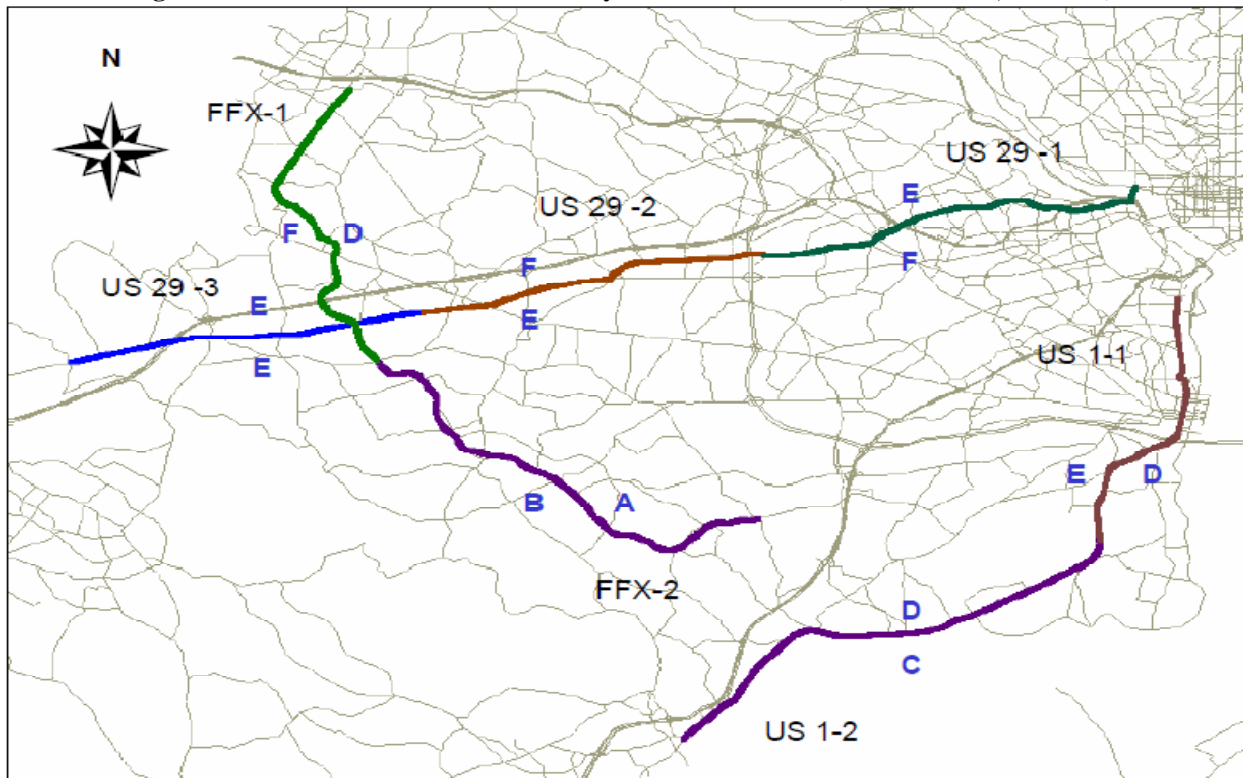

Figure B8: PM Peak Period LOS for Surveyed Arterials in VA (4:00-7:00 PM, FY 2008)

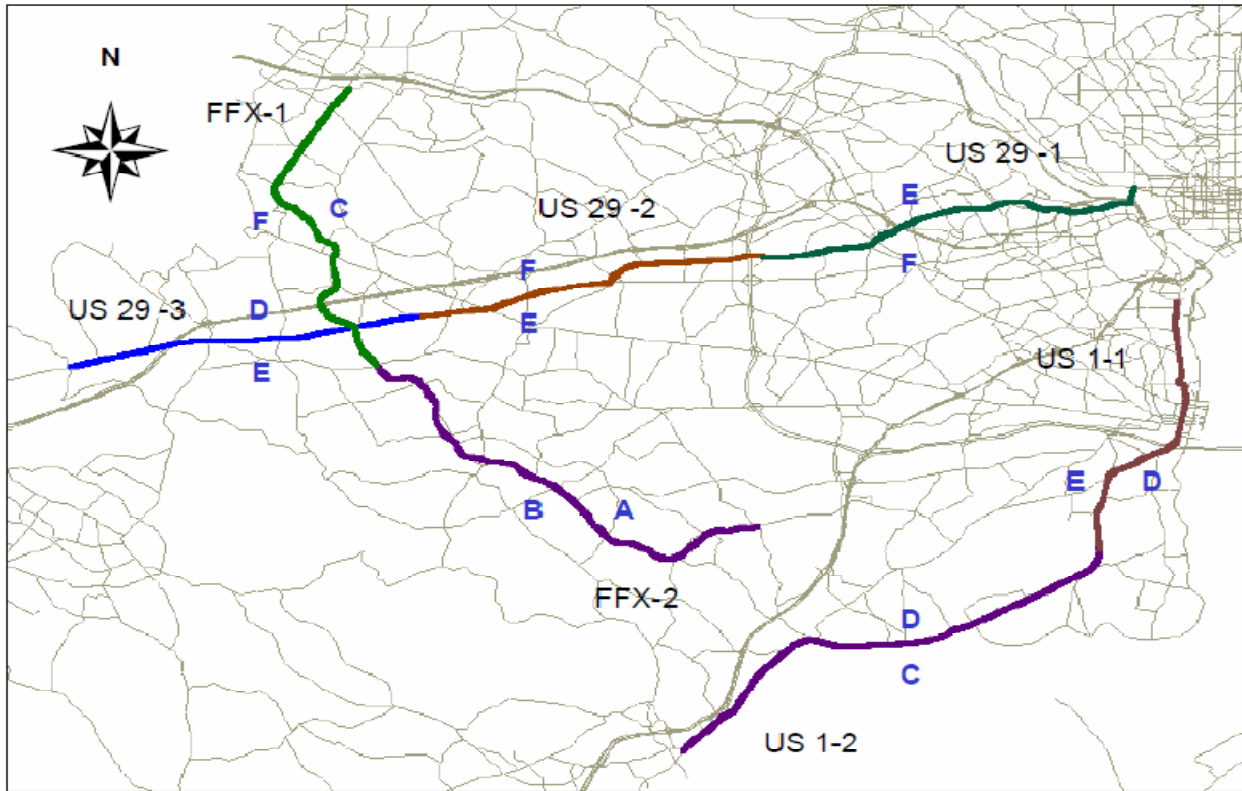
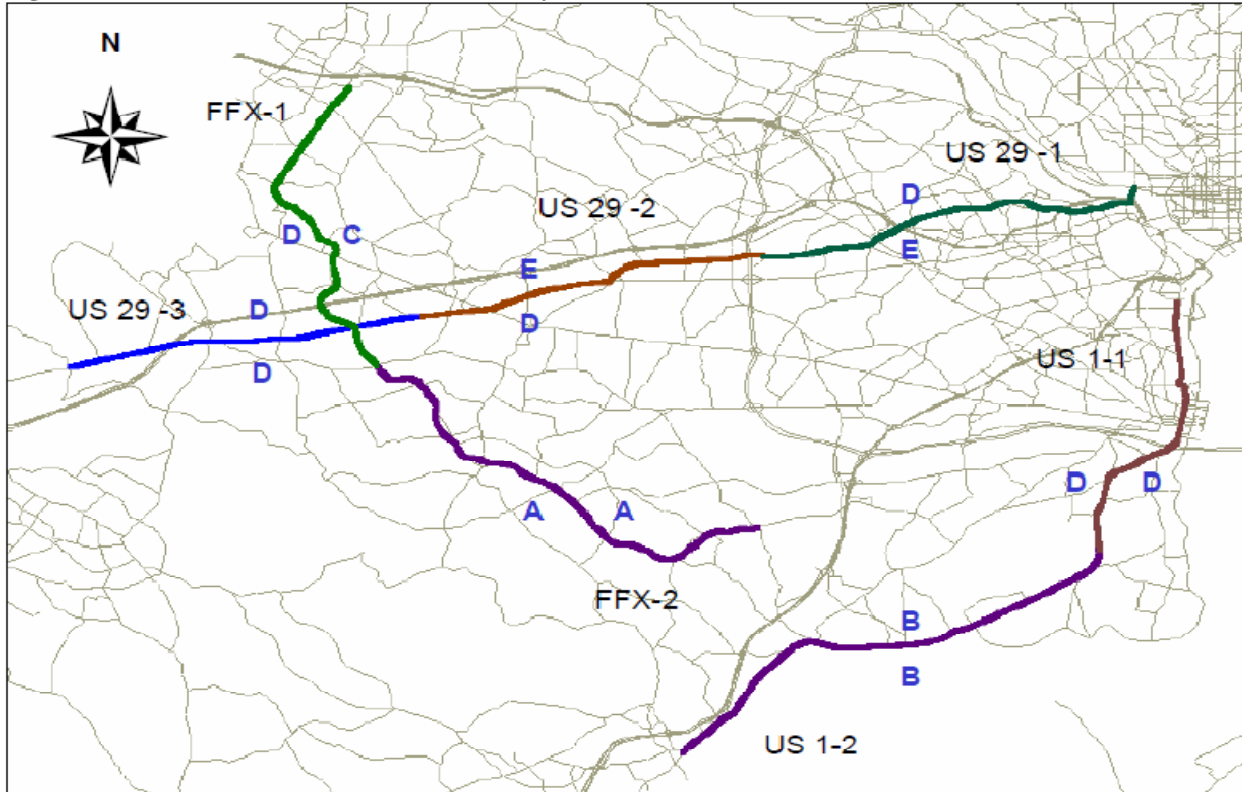

Figure B9: PM Off-Peak Period LOS for Surveyed Arterials in VA (1:00-4:00 PM & 7:00-8:00 PM, FY 2008)



FY 2009 Study

The FY 2009 study⁷² was conducted between early December 2008 and the mid of April 2009. This study surveyed 141.1 centerline miles of arterial highways during the PM period. This includes 114.9 centerline miles of arterial highways which were surveyed during the FY 2003 and FY 2006 study period and 26.2 centerline miles⁷³ of arterial highways which were not surveyed during the FY 2003, and FY 2006 studies. The new routes are Wilson-Clarendon Blvd. in Virginia, Rhode Island in the District of Columbia, and Baltimore Avenue (US-1) and University Blvd. (MD193) in Maryland. In total about 59.8, 68.1, and 13.2 centerline miles of arterial highways surveyed belongs to routes from Maryland, Virginia and the District of Columbia respectively. This includes 41.8, 63.2, and 9.9 centerline miles of arterial highways from Maryland, Virginia and the District of Columbia surveyed in the FY 2002 and FY 2006 study period. The routes and limits of this study are listed in **Table B3** and a summary of LOS by time period and by direction is presented in **Table B4**. The LOS results are also mapped in **Figures B10 through B18** for peak hour (5:00-6:00 PM), peak period (4:00-7:00 PM) and off-peak period (1:00-4:00 PM & 7:00-8:00 PM) respectively.

Table B3: Routes and Limits (FY 2009)

Jurisdiction	Route	Route Limits		Distance (miles)
		From	To	
MD	MD 355 (Segment 1 & 2)	Western Ave	Montgomery Village Ave	15.3
	MD 117	Muddy Branch Rd	Clarksburg Rd	6.8
	MD 198	MD 650	Old Gunpowder Rd	5.0
	MD 197	MD 198	US 301	14.7
	<i>US-1/ Baltimore Av. (Seg-1& 2)</i>	<i>Eastern Ave</i>	<i>MD 198</i>	<i>13.4</i>
	<i>MD 193</i>	<i>Collesville Rd</i>	<i>Adelphi Rd</i>	<i>4.6</i>
MD Total				59.8
VA	US 50 (Segment 1 & 2)	Henry Bacon Dr	Centerview Dr	23.0
	US 15	VA 7	Lovettsville Rd	12.5
	VA 123 (Segment 1, 2 & 3)	Kirby Rd	Old Courthouse Rd	27.7
	<i>Wilson Blvd</i>	<i>N. Lynn St.</i>	<i>Roosevelt Blvd</i>	<i>4.9</i>
VA Total				68.1
DC	Wisconsin Ave	M Street	Western Ave	4.1
	Pennsylvania Ave	M Street	17th Street NW	1.1
	17th Street	Pennsylvania Ave	Independence Ave	0.7
	Independence Ave	17th Street	2nd Street SE	1.9
	I Street	14th Street	Pennsylvania Ave	0.8
	H Street	Pennsylvania Ave	14th Street NW	0.6
	15th Street	Independence Ave	E Street NW	0.7
	<i>Rhode Island Ave (US-1)</i>	<i>Florida Ave</i>	<i>Eastern Ave</i>	<i>3.3</i>
DC Total				13.2
Regional Total				141.1

Note: Routes in *Italic* are FY 2009 new routes surveyed (total 26.2 miles).

⁷² Draft Findings From the FY 2009 Enhanced Arterial Highway Travel Time/Speed Study, Presented to the Travel Forecasting Subcommittee meeting 2009-09-18. <http://www.mwcog.org/uploads/committee-documents/aF5bVlpc20090920152341.pdf>

⁷³ Additional Routes for Enhancing the Arterial Highway Congestion Monitoring Program in the Washington Region, Presented to the Travel Forecasting Subcommittee meeting 2008-11-21. <http://www.mwcog.org/uploads/committee-documents/a15dWldc20081121140630.pdf>

Table B4: LOS by Time Period and by Direction (FY 2009)

Jurisdiction	Route	LOS (Peak Hour)		LOS (Off-Peak Period)		LOS (Peak Period)	
		North/ Eastbound	South/ Westbound	North/ Eastbound	South/ Westbound	North/ Eastbound	South/ Westbound
MD	MD 355 – Seg 2	E	E	D	D	E	E
	MD 355 – Seg 1	D	D	C	D	D	D
	MD 117	C	C	B	B	C	C
	MD 198	B	C	B	B	B	C
	MD 197	B	B	B	B	B	B
	<i>US-1/ Baltimore Ave - Seg 1</i>	D	D	C	C	C	C
	<i>US-1/ Baltimore Ave - Seg 2</i>	D	C	C	C	D	C
	<i>MD 193</i>	D	D	D	D	D	C
VA	US 50 – Seg 1	C	E	B	B	C	D
	US 50 – Seg 2	E	E	C	C	D	D
	US 15	C	A	A	A	B	A
	VA 123 – Seg 1	E	E	C	C	D	E
	VA 123 – Seg 2	D	E	D	D	D	E
	VA 123 – Seg 3	A	B	A	A	A	B
	<i>Wilson Blvd</i>	C	D	C	C	C	D
DC	Wisconsin Ave	D	D	E	D	D	E
	Pennsylvania Ave	E	D	D	D	D	D
	17th Street	D	F	C	D	C	E
	Independence Ave	D	D	D	C	D	D
	I Street	-	E	-	E	-	E
	H Street	E	-	E	-	F	-
	15th Street	C	E	C	C	C	D
	<i>Rhode Island Ave (US-1)</i>	E	D	D	D	D	D

Note: Routes in *Italic* are FY 2009 new routes surveyed (total 26.2 miles).

Figure B10: PM Peak Hour LOS for Surveyed Arterials in DC (5:00-6:00 PM, FY 2009)

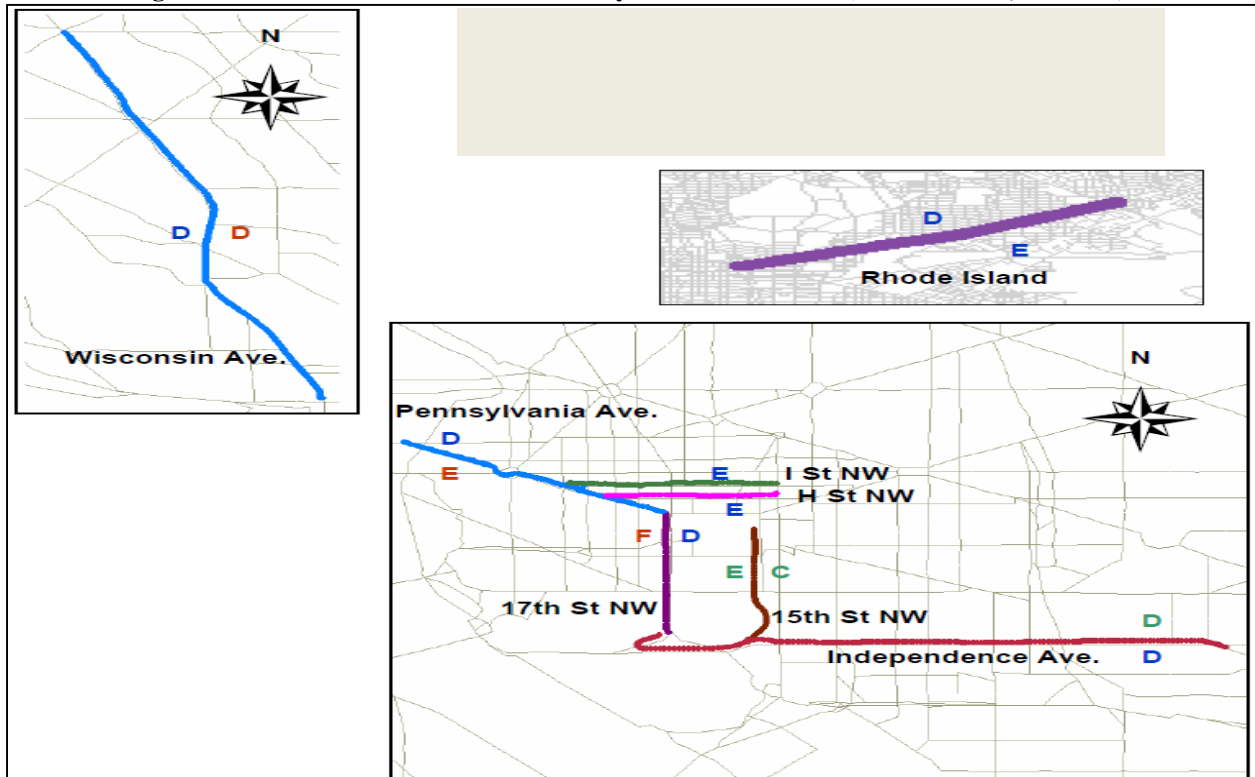

Figure B11: PM Peak Period LOS for Surveyed Arterials in DC (4:00-7:00 PM, FY 2009)

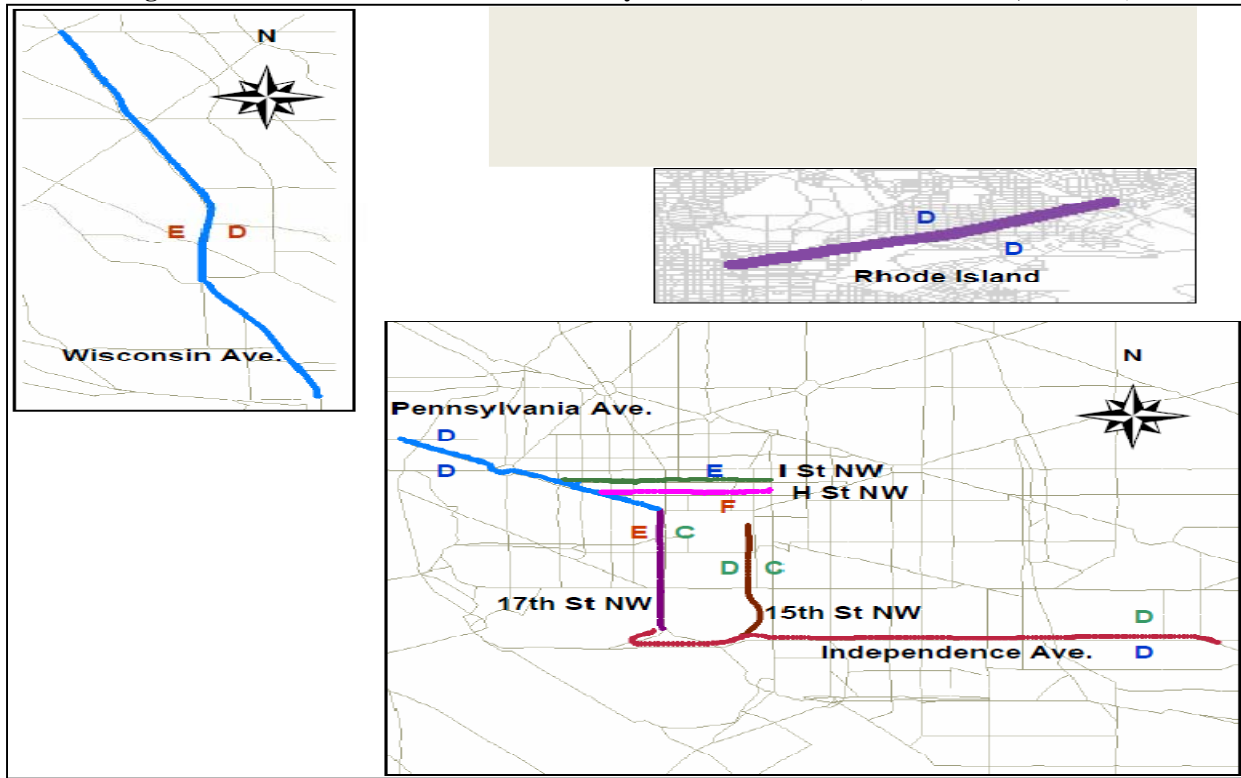

Figure B12: PM Off-Peak Period LOS for Surveyed Arterials in DC (1:00-4:00 PM & 7:00-8:00 PM, FY 2009)

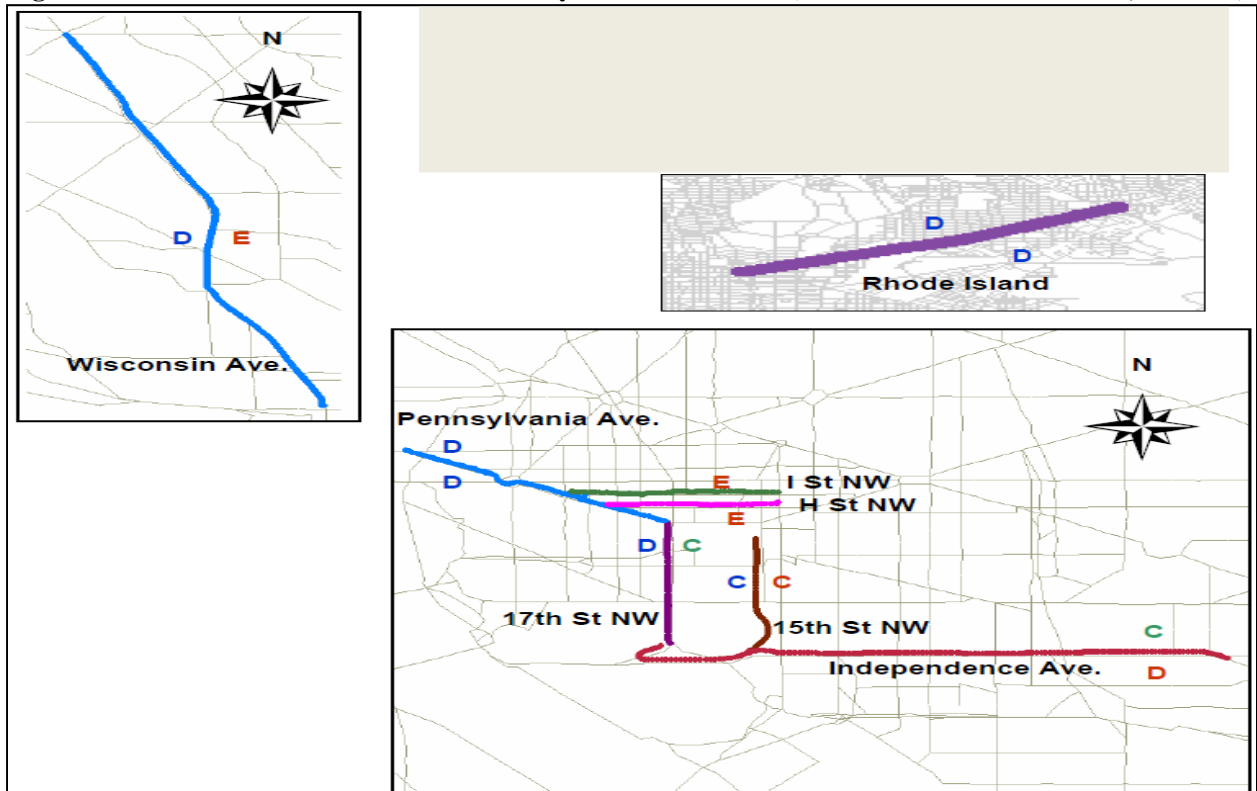

Figure B1338: PM Peak Hour LOS for Surveyed Arterials in MD (5:00-6:00 PM, FY 2009)

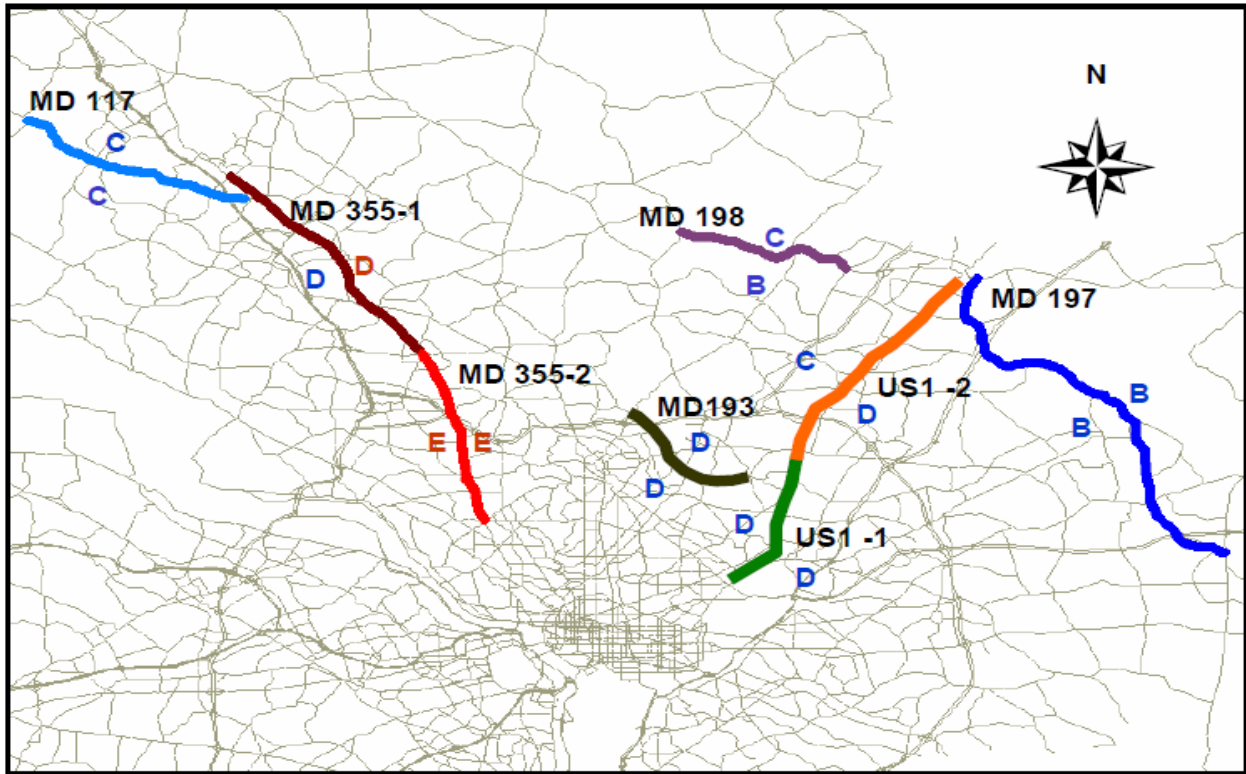

Figure B14: PM Peak Period LOS for Surveyed Arterials in MD (4:00-7:00 PM, FY 2009)

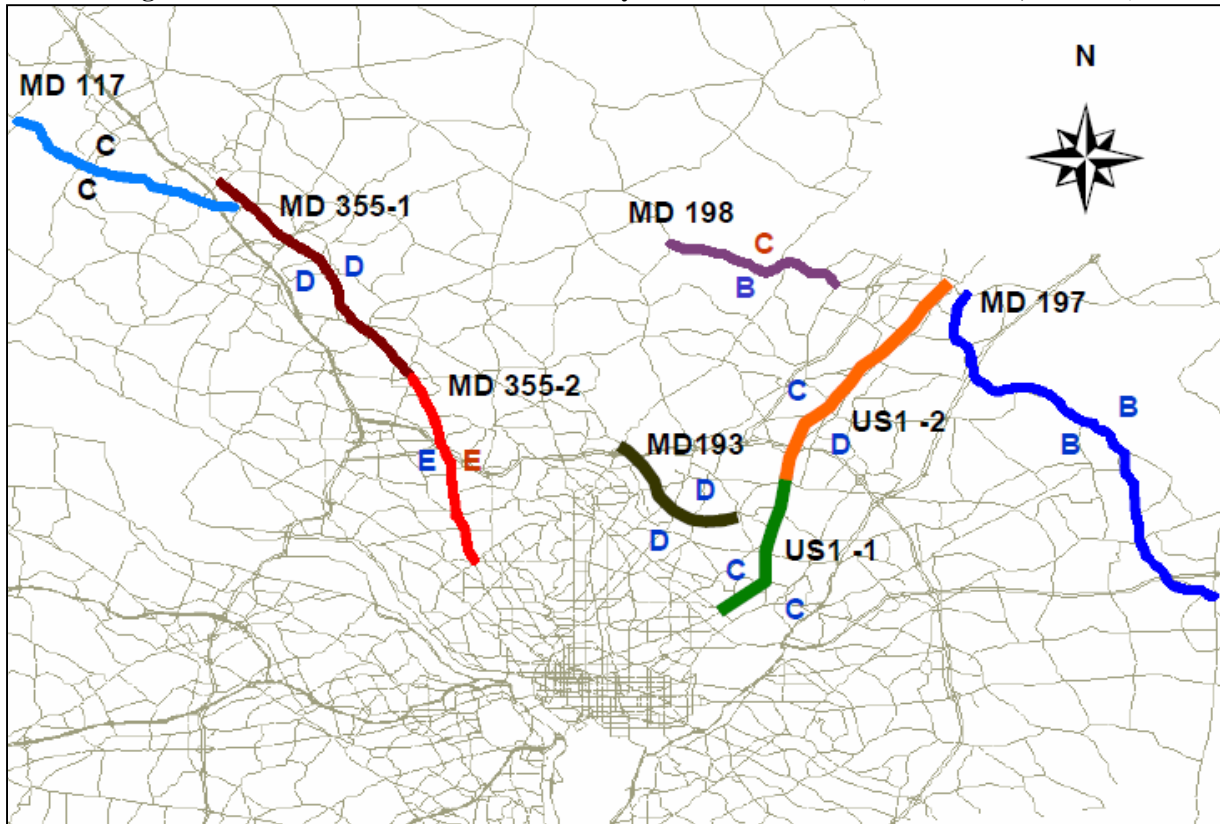

Figure B15: PM Off-Peak Period LOS for Surveyed Arterials in MD (1:00-4:00 PM & 7:00-8:00 PM, FY 2009)

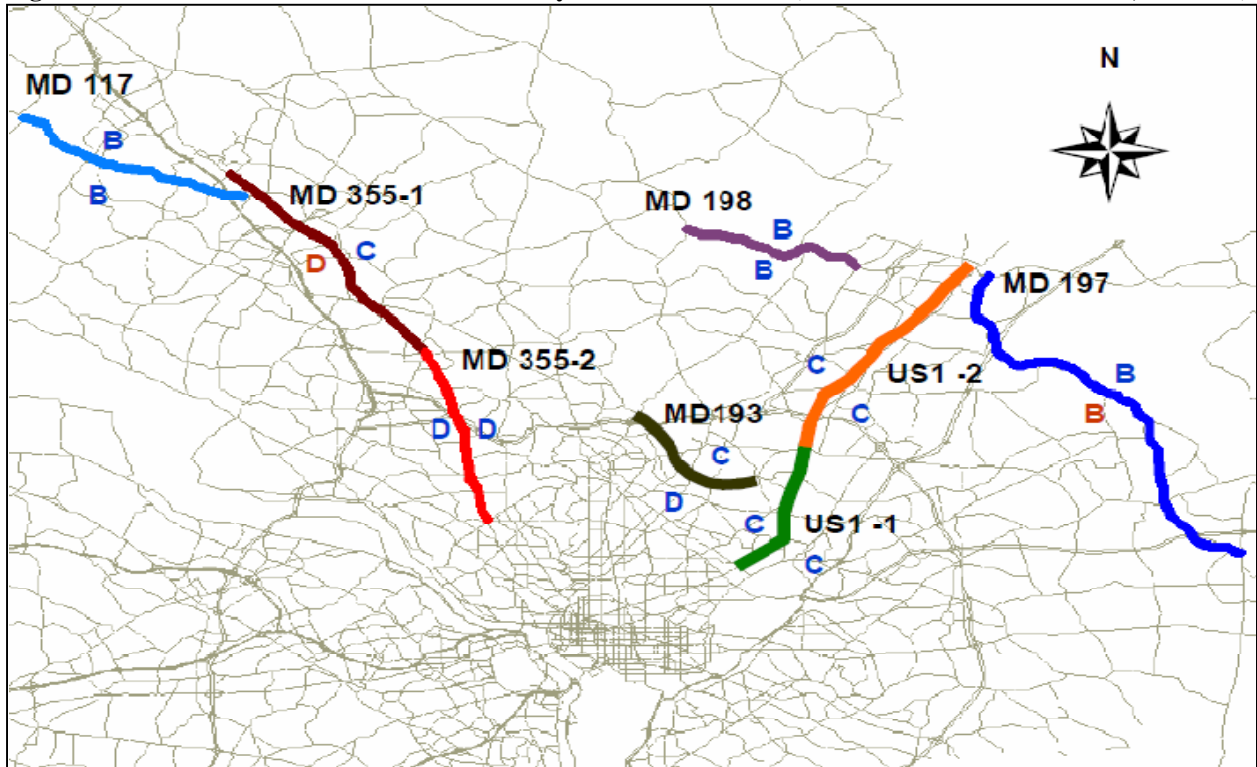

Figure B16: PM Peak Hour LOS for Surveyed Arterials in VA (5:00-6:00 PM, FY 2009)

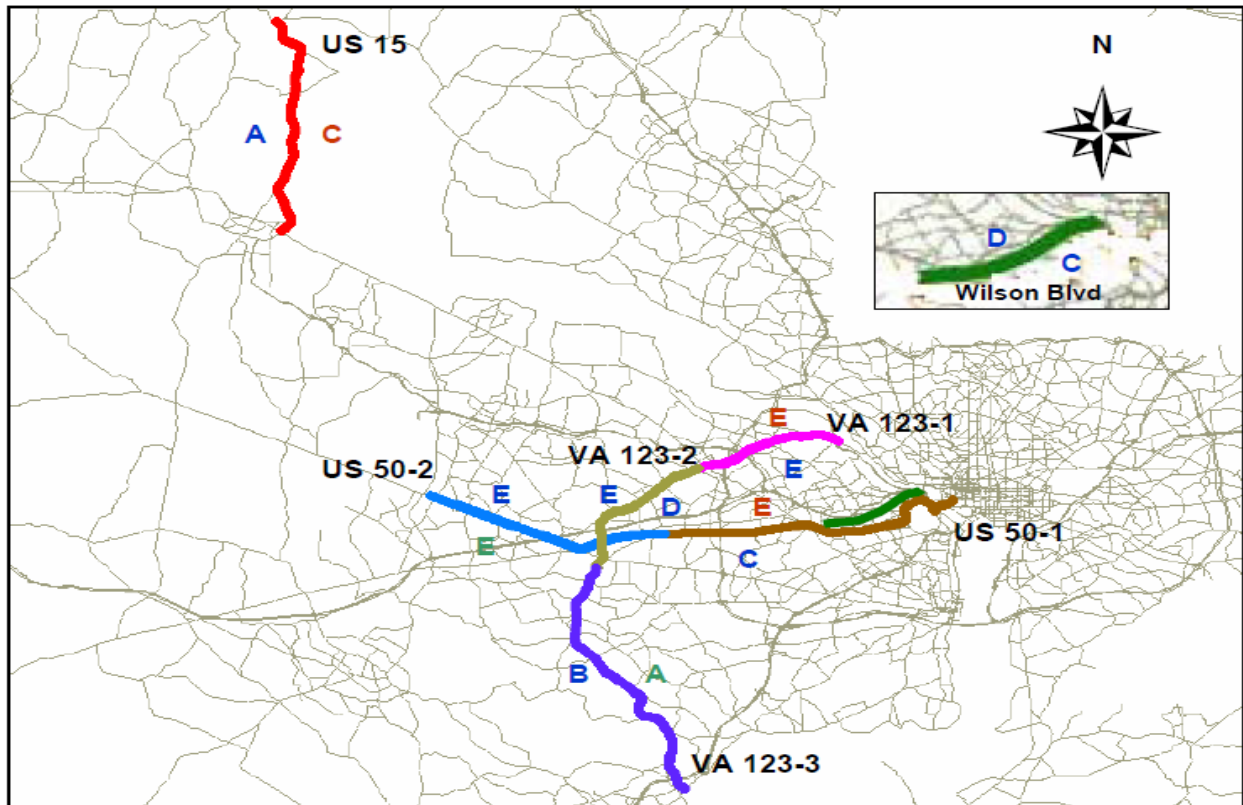

Figure B17: PM Peak Period LOS for Surveyed Arterials in VA (4:00-7:00 PM, FY 2009)

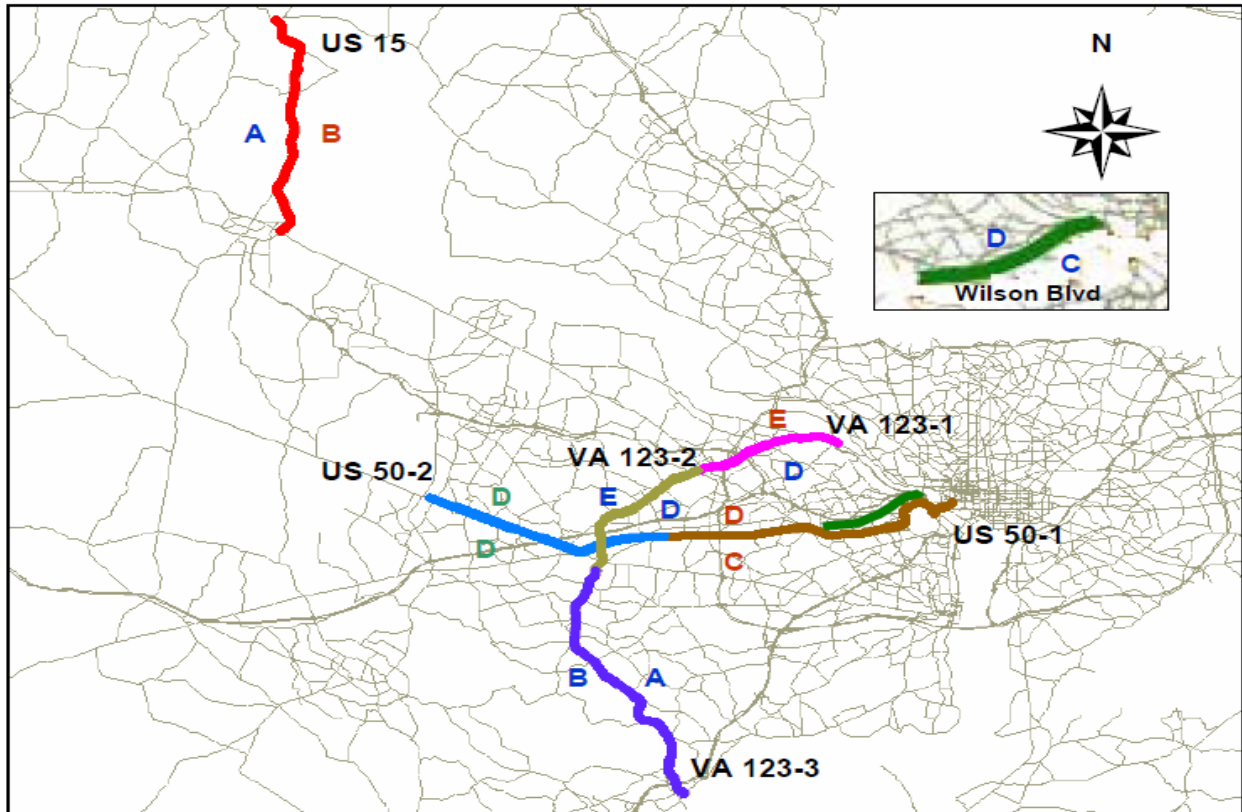
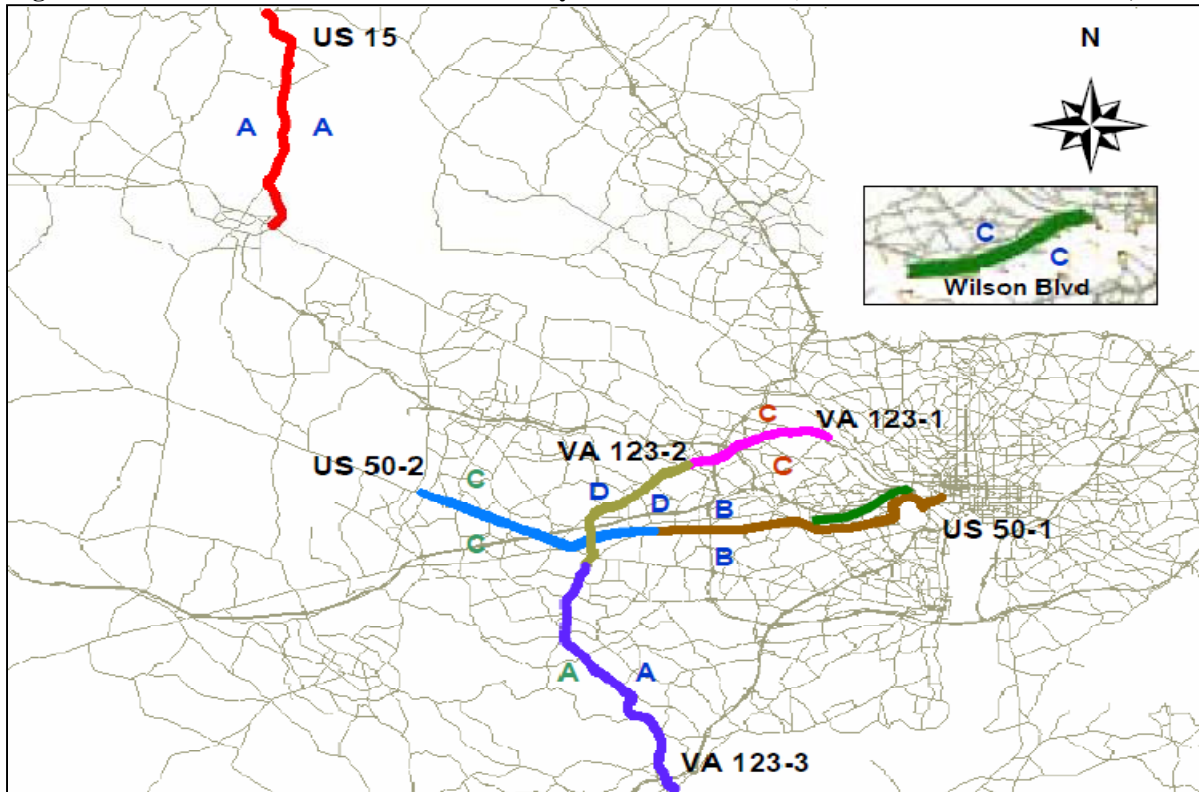

Figure B18: PM Off-Peak Period LOS for Surveyed Arterials in VA (1:00-4:00 PM & 7:00-8:00 PM, FY 2009)



**APPENDIX C – TRAVEL TIME INDEX OF THE I-95 CORRIDOR COALITION VEHICLE
PROBE PROJECT COVERED HIGHWAYS IN THE TPB MEMBER JURISDICTIONS**

(Blank)

Figure C1: Travel Time Index: 2009 All Time (24/7/365) for the I-95 Corridor Coalition Covered Highways

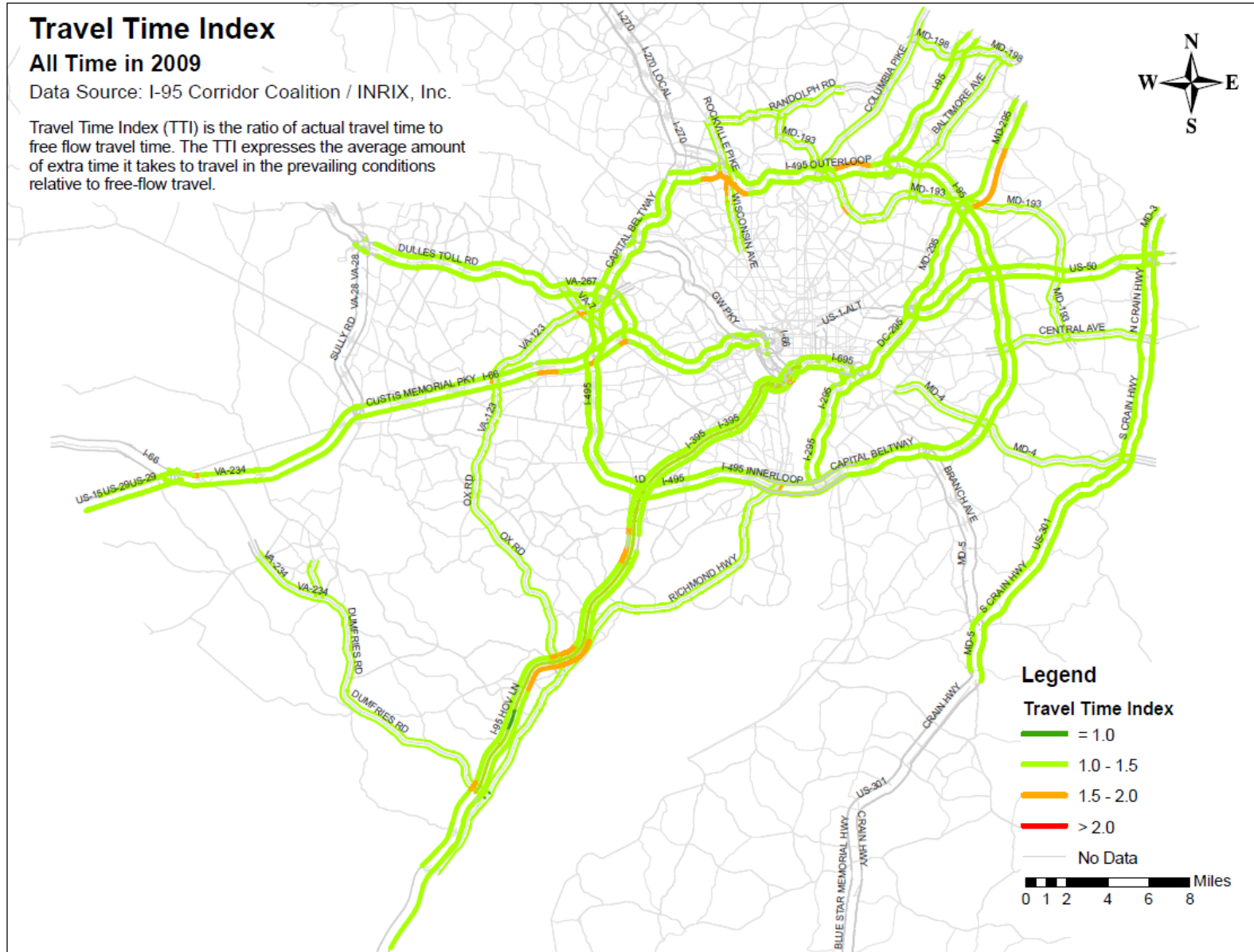

Figure C2: Travel Time Index: 2009 Workday AM Peak (6:00-10:00 AM) for the I-95 Corridor Coalition Covered Highways

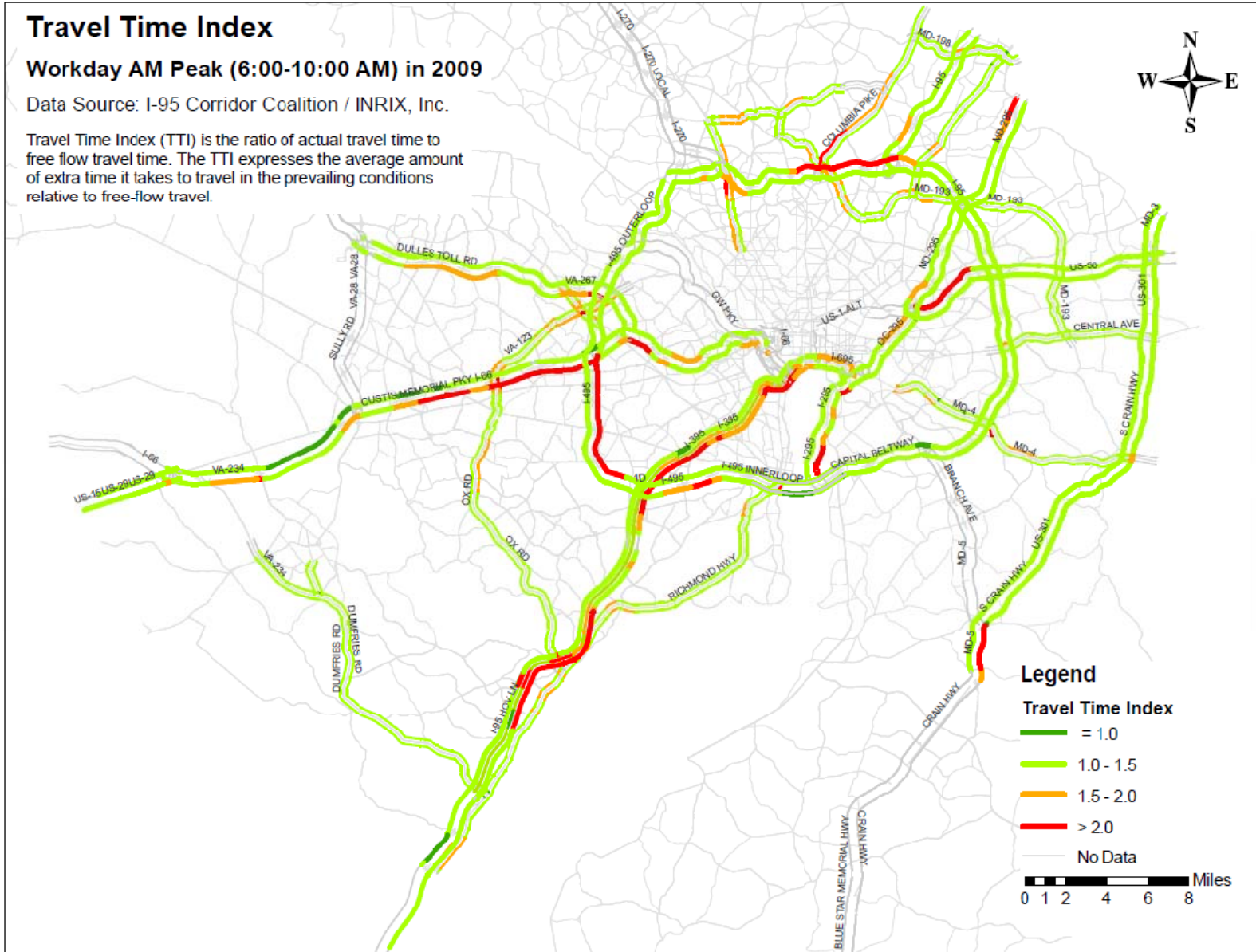

Figure C3: Travel Time Index: 2009 Workday PM Peak (3:00-7:00 PM) for the I-95 Corridor Coalition Covered Highways

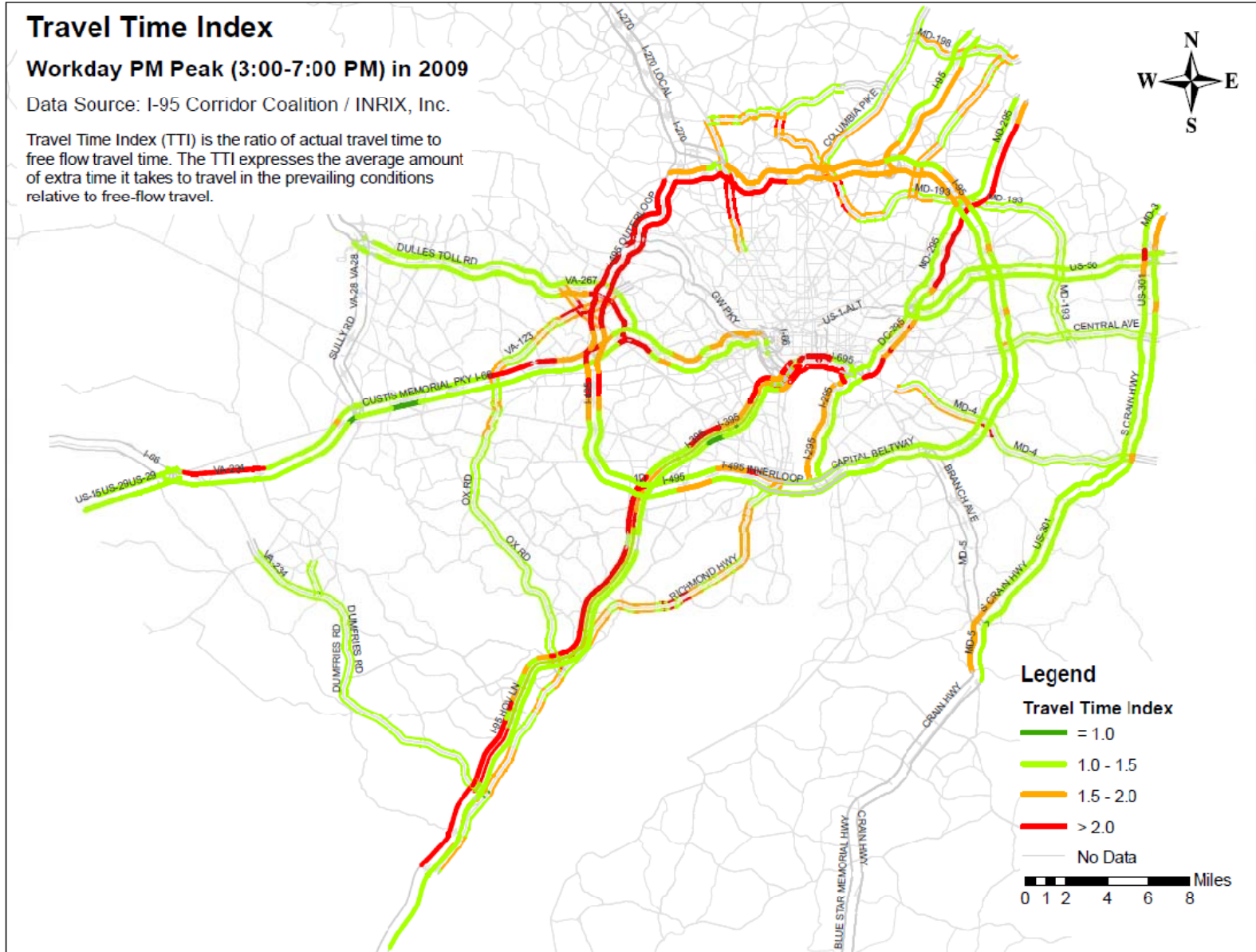

Figure C4: Travel Time Index: 2009 Workday Midday 10:00 AM - 3:00 PM for the I-95 Corridor Coalition Covered Highways

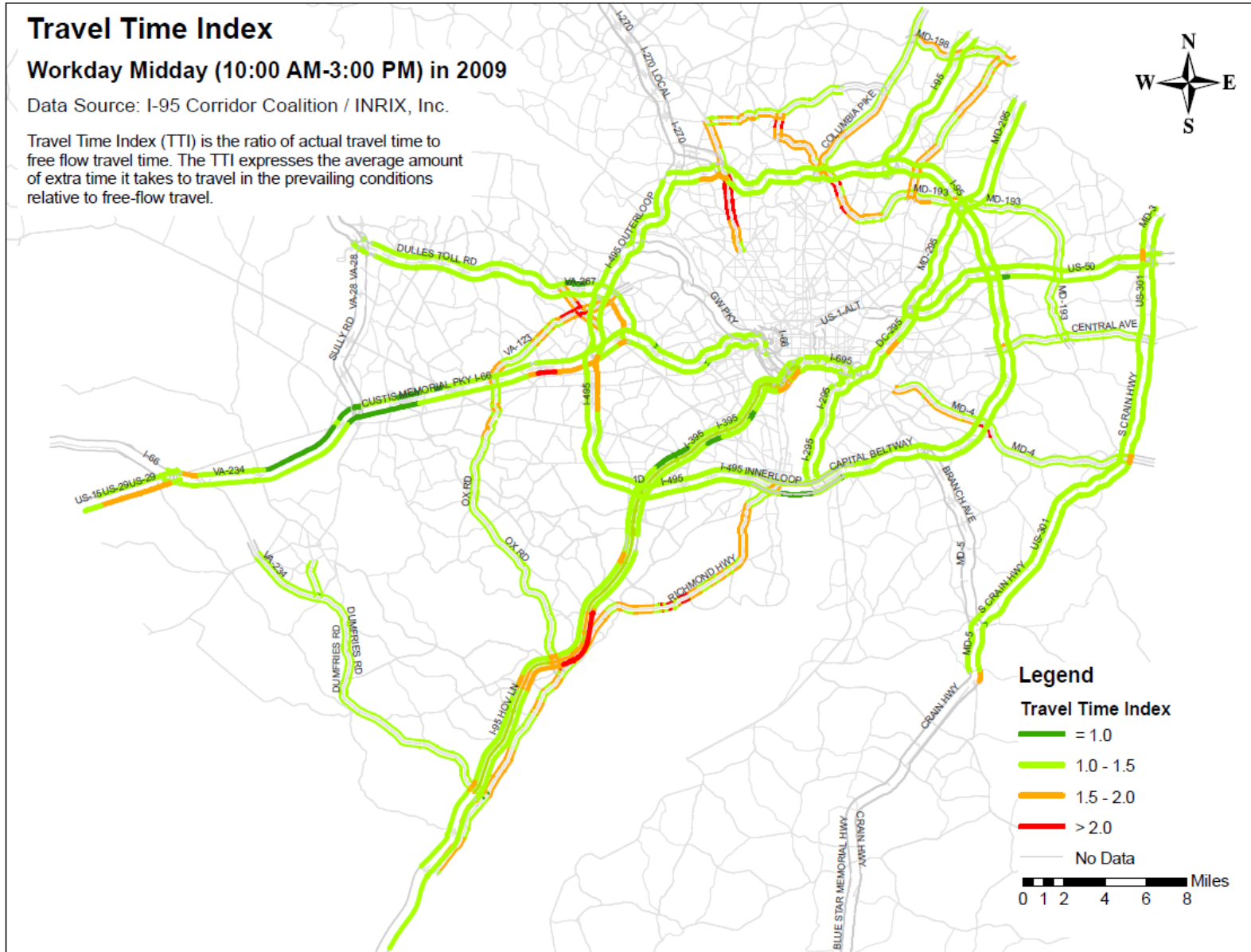

Figure C6: Travel Time Index: 2009 Workday Morning 6:00-7:00 AM for the I-95 Corridor Coalition Covered Highways

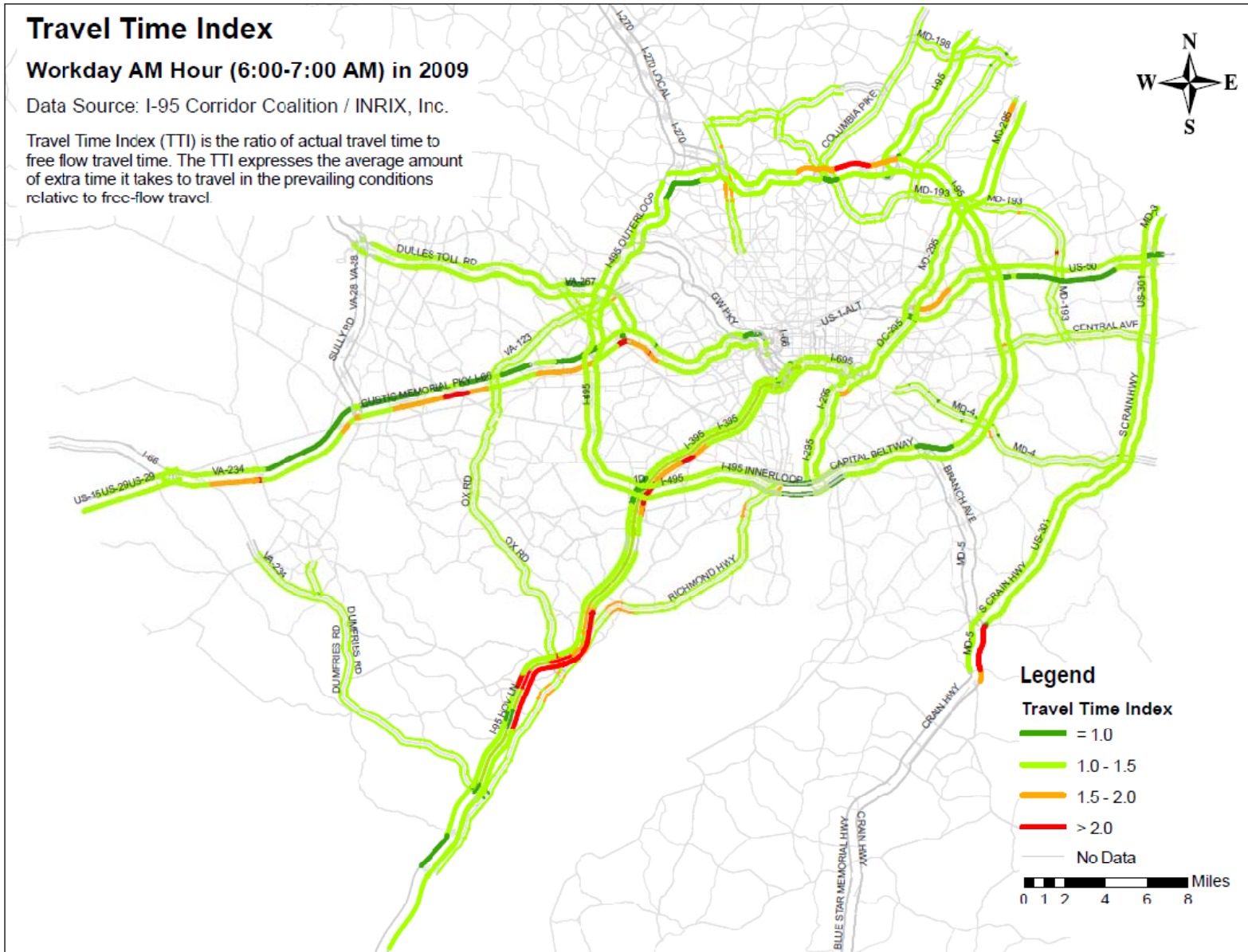

Figure C7: Travel Time Index: 2009 Workday Morning 7:00-8:00 AM for the I-95 Corridor Coalition Covered Highways

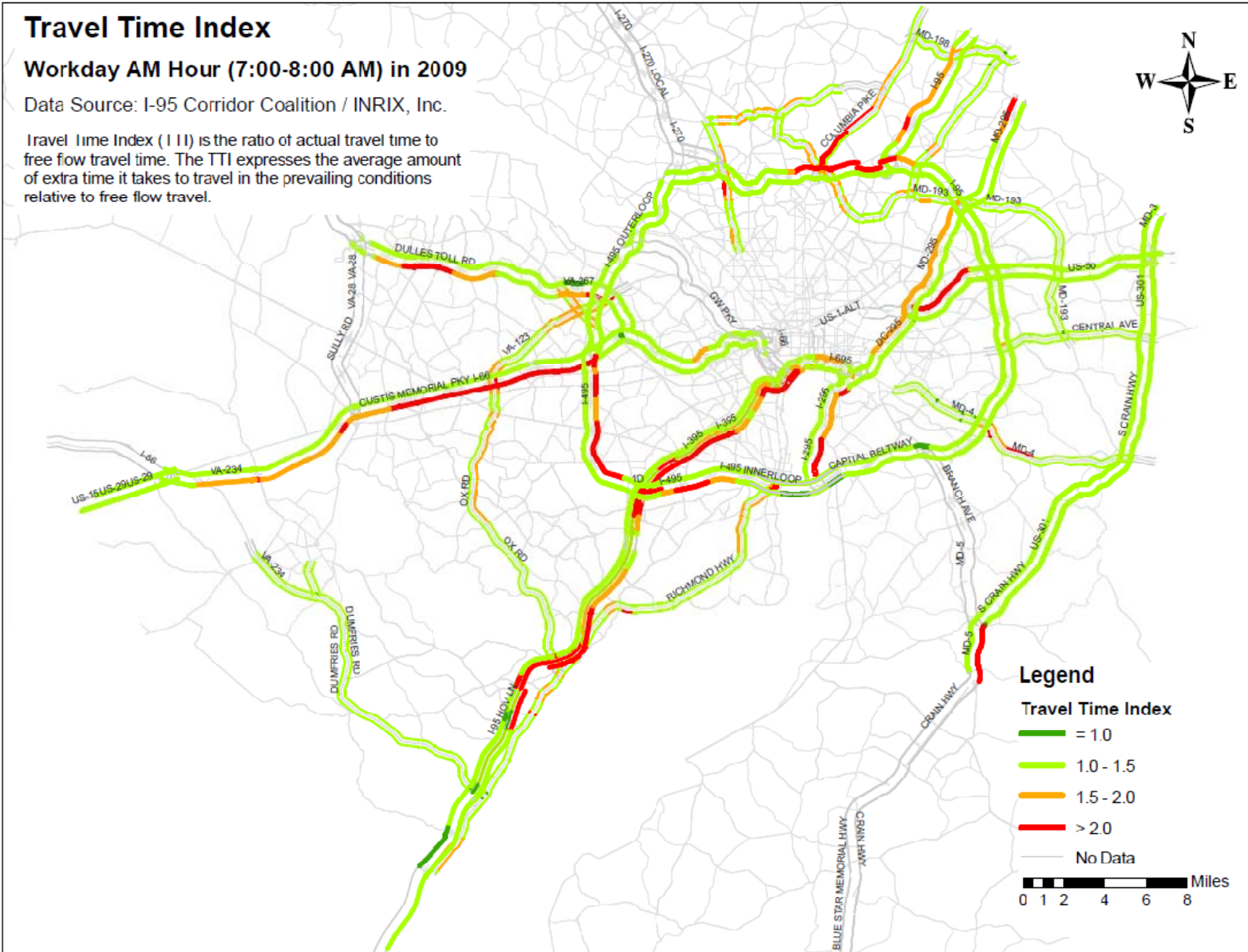

Figure C9: Travel Time Index: 2009 Workday Morning 9:00-10:00 AM for the I-95 Corridor Coalition Covered Highways

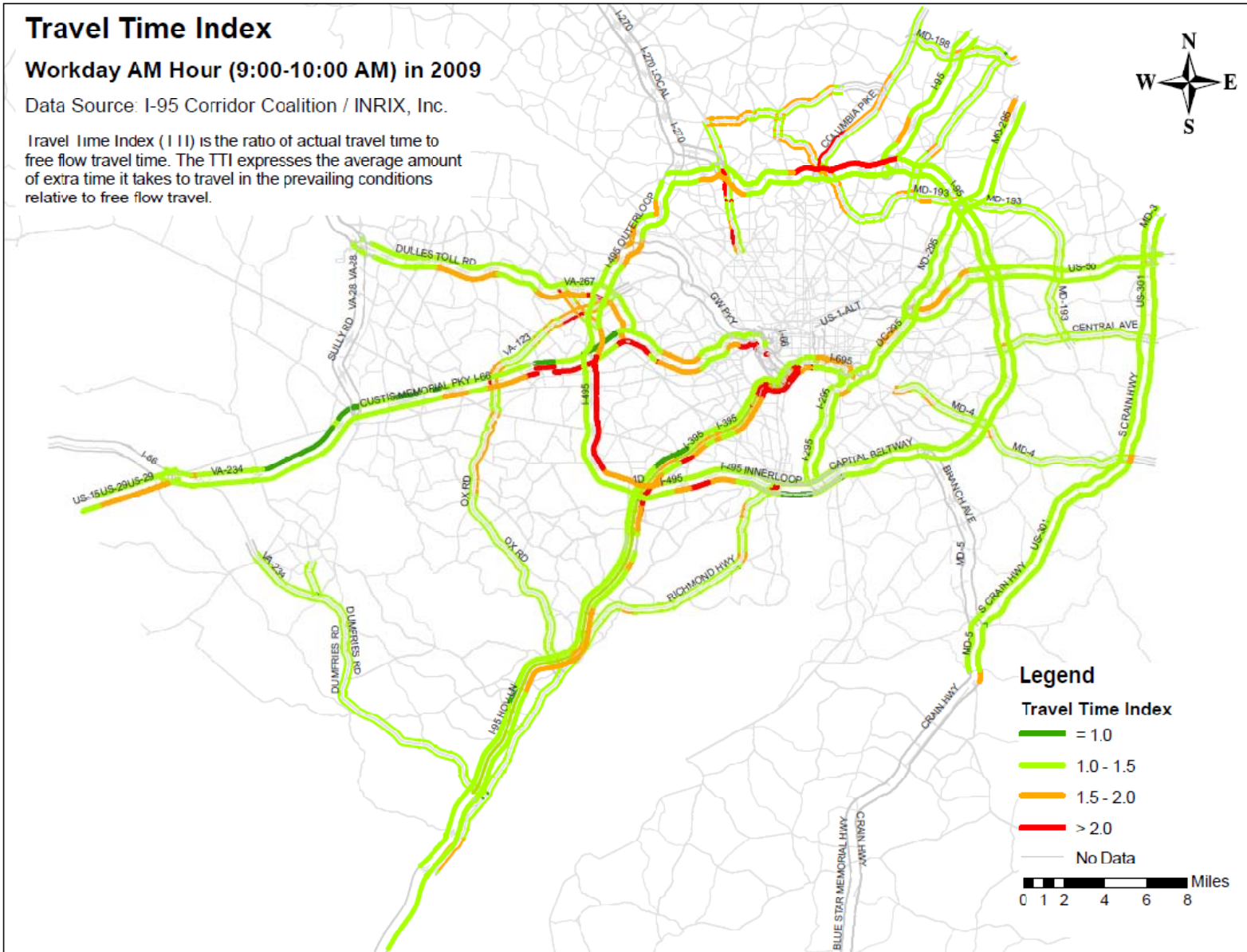

Figure C10: Travel Time Index: 2009 Workday Afternoon 3:00-4:00 PM for the I-95 Corridor Coalition Covered Highways

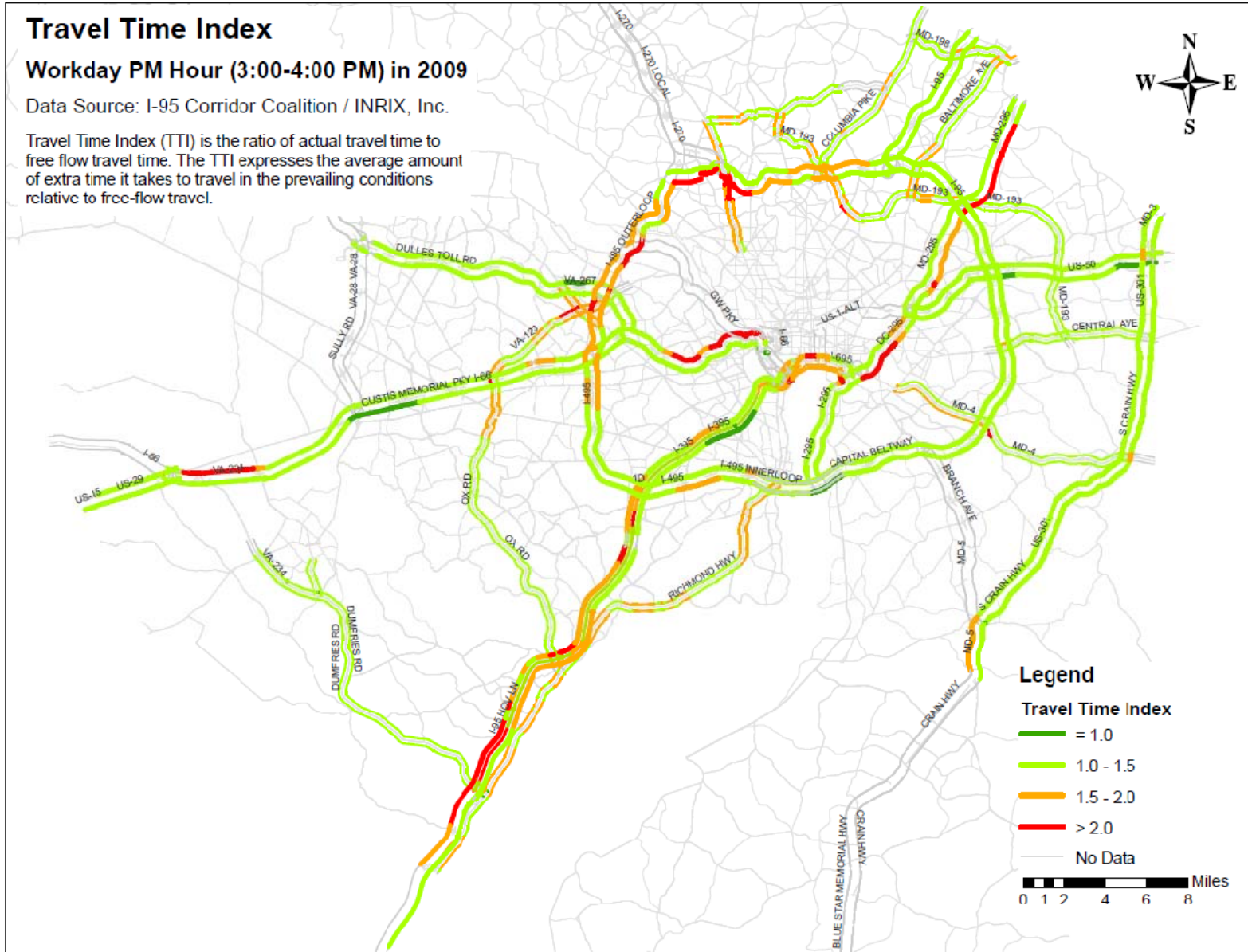

Figure C12: Travel Time Index: 2009 Workday Afternoon 5:00-6:00 PM for the I-95 Corridor Coalition Covered Highways

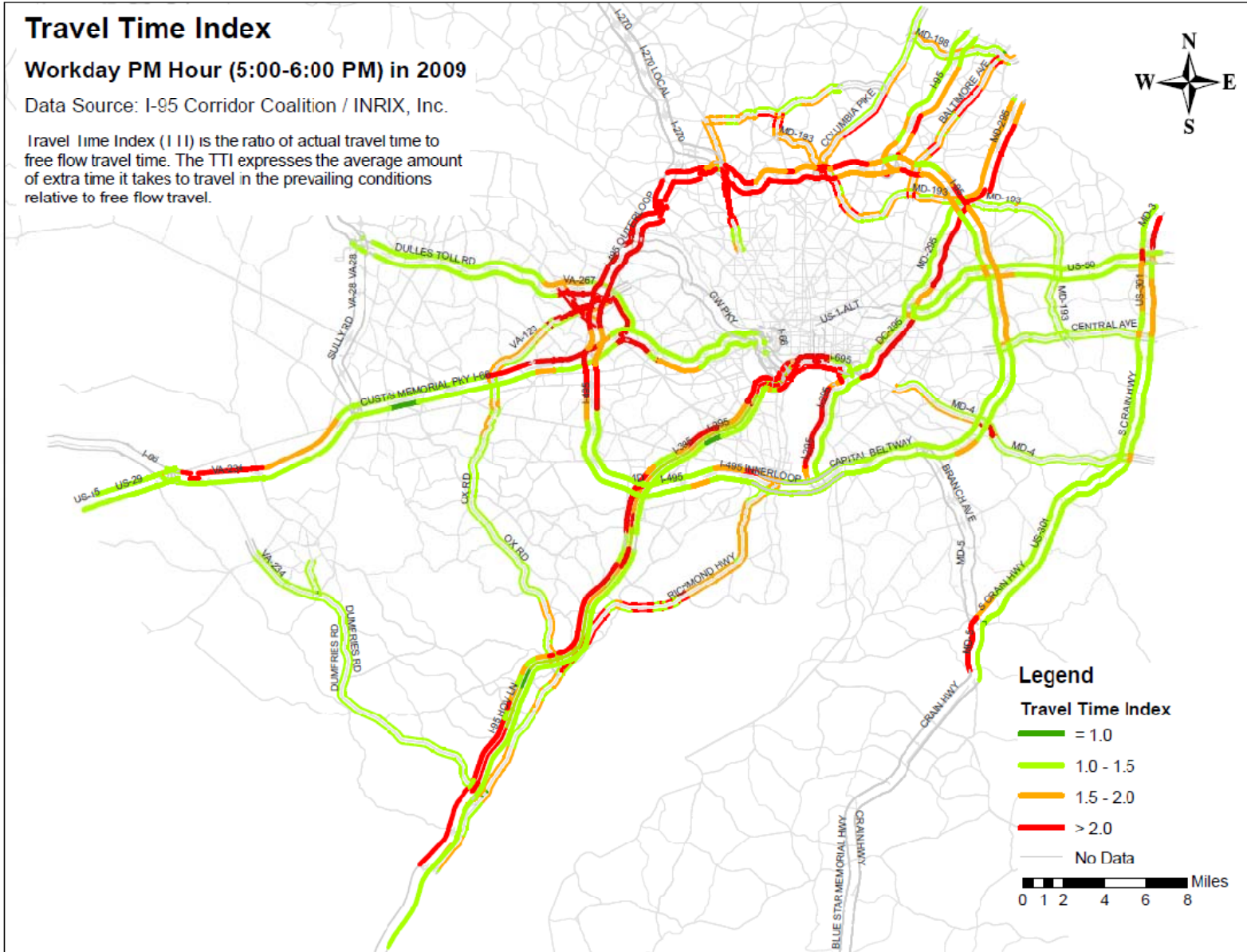
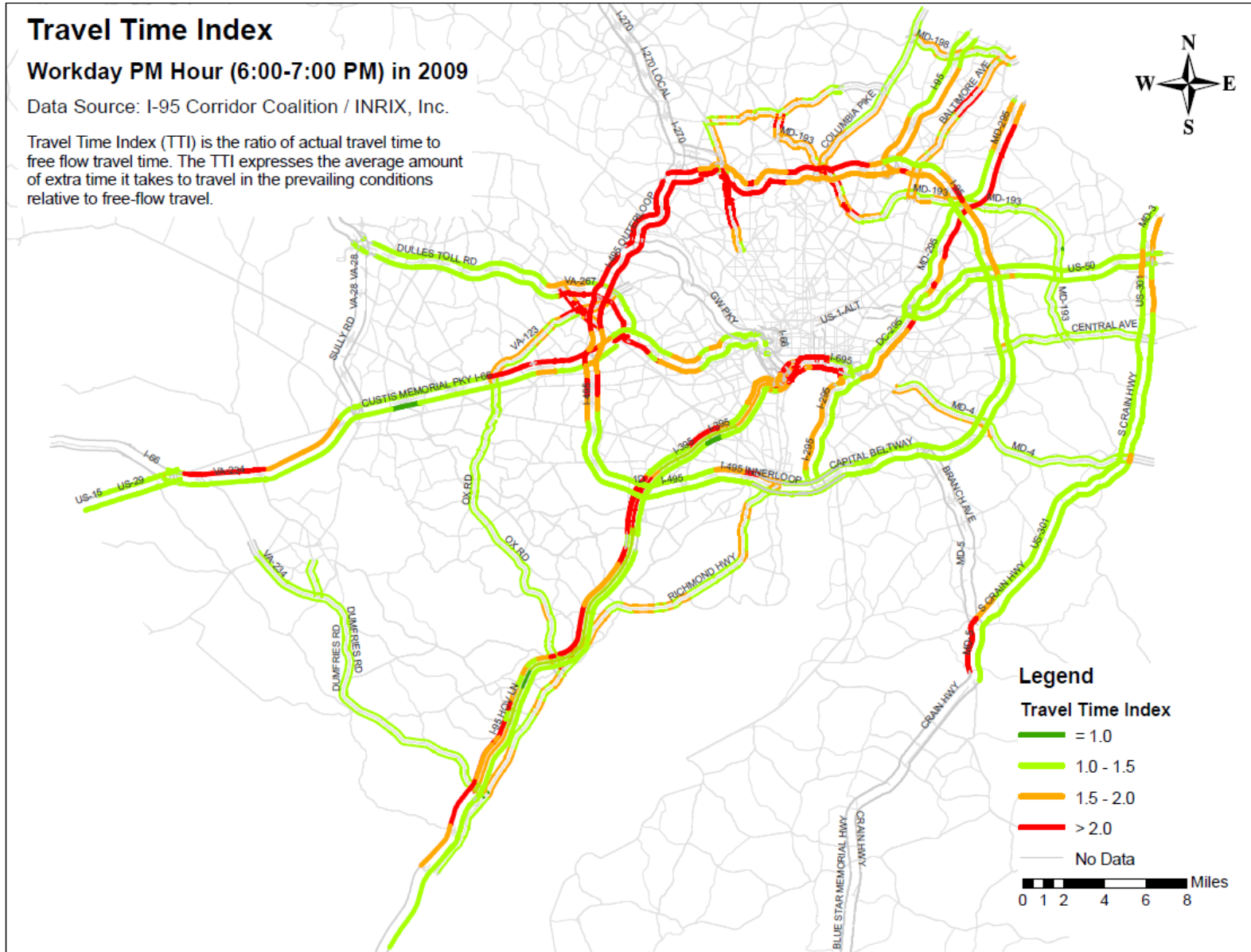

Figure C13: Travel Time Index: 2009 Workday Afternoon 6:00-7:00 PM for the I-95 Corridor Coalition Covered Highways



**APPENDIX D – PLANNING TIME INDEX OF THE I-95 CORRIDOR COALITION
VEHICLE PROBE PROJECT COVERED HIGHWAYS IN THE TPB MEMBER
JURISDICTIONS**

(Blank)

Figure D1: Planning Time Index: 2009 All Time (24/7/365) for the I-95 Corridor Coalition Covered Highways

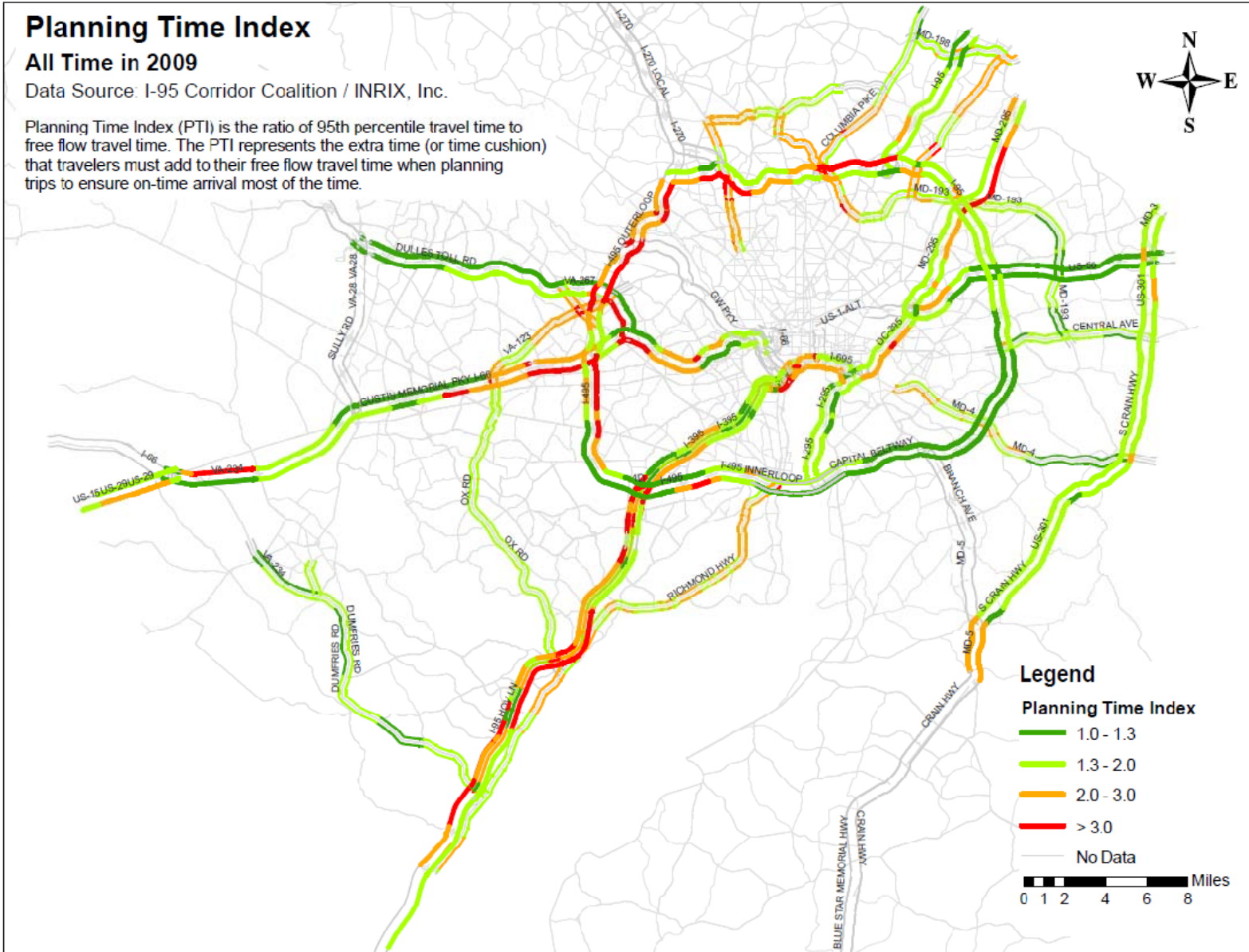

Figure D2: Planning Time Index: 2009 Workday AM Peak (6:00-10:00 AM) for the I-95 Corridor Coalition Covered Highways

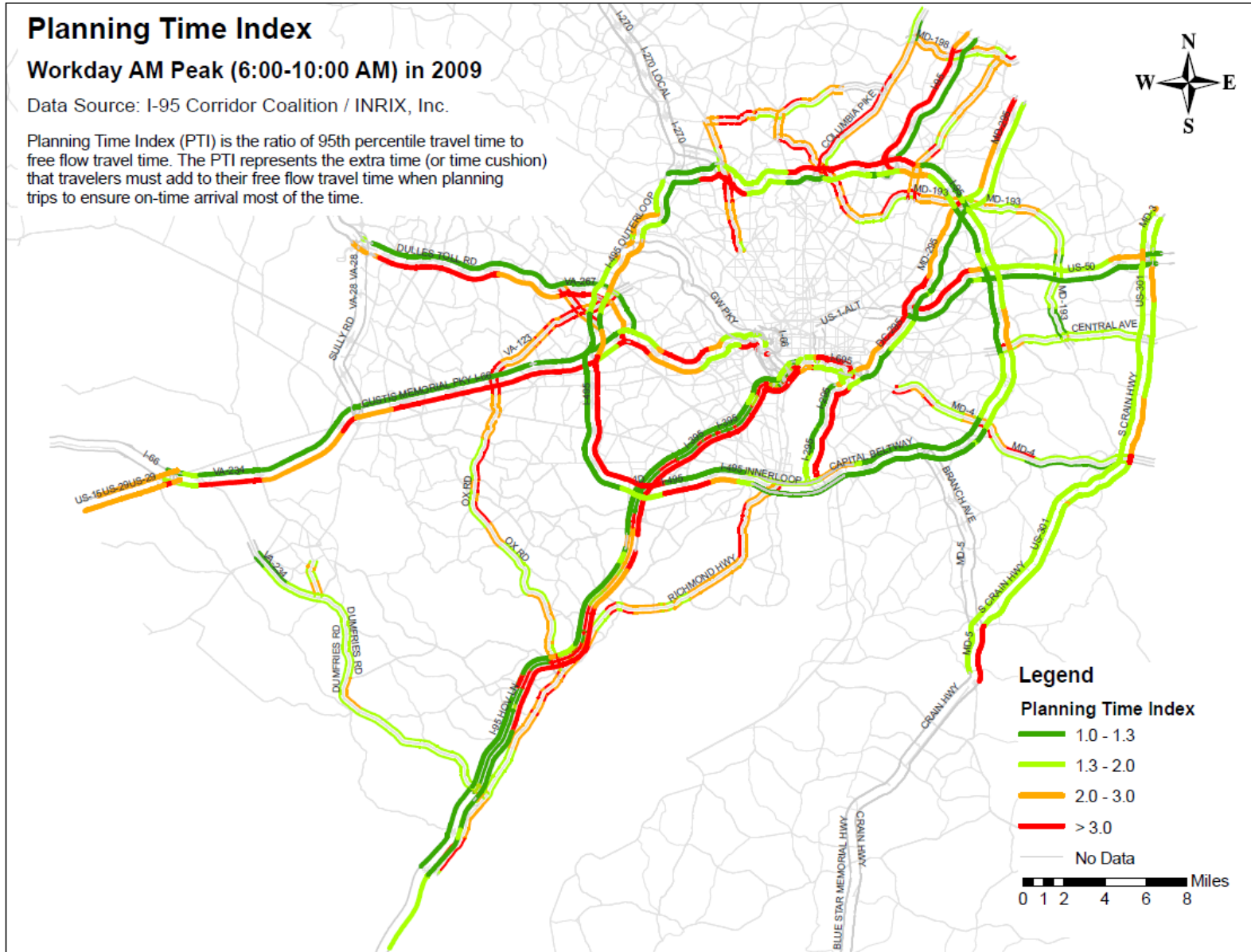

Figure D5: Planning Time Index: 2009 Weekend 10:00 AM - 7:00 PM for the I-95 Corridor Coalition Covered Highways

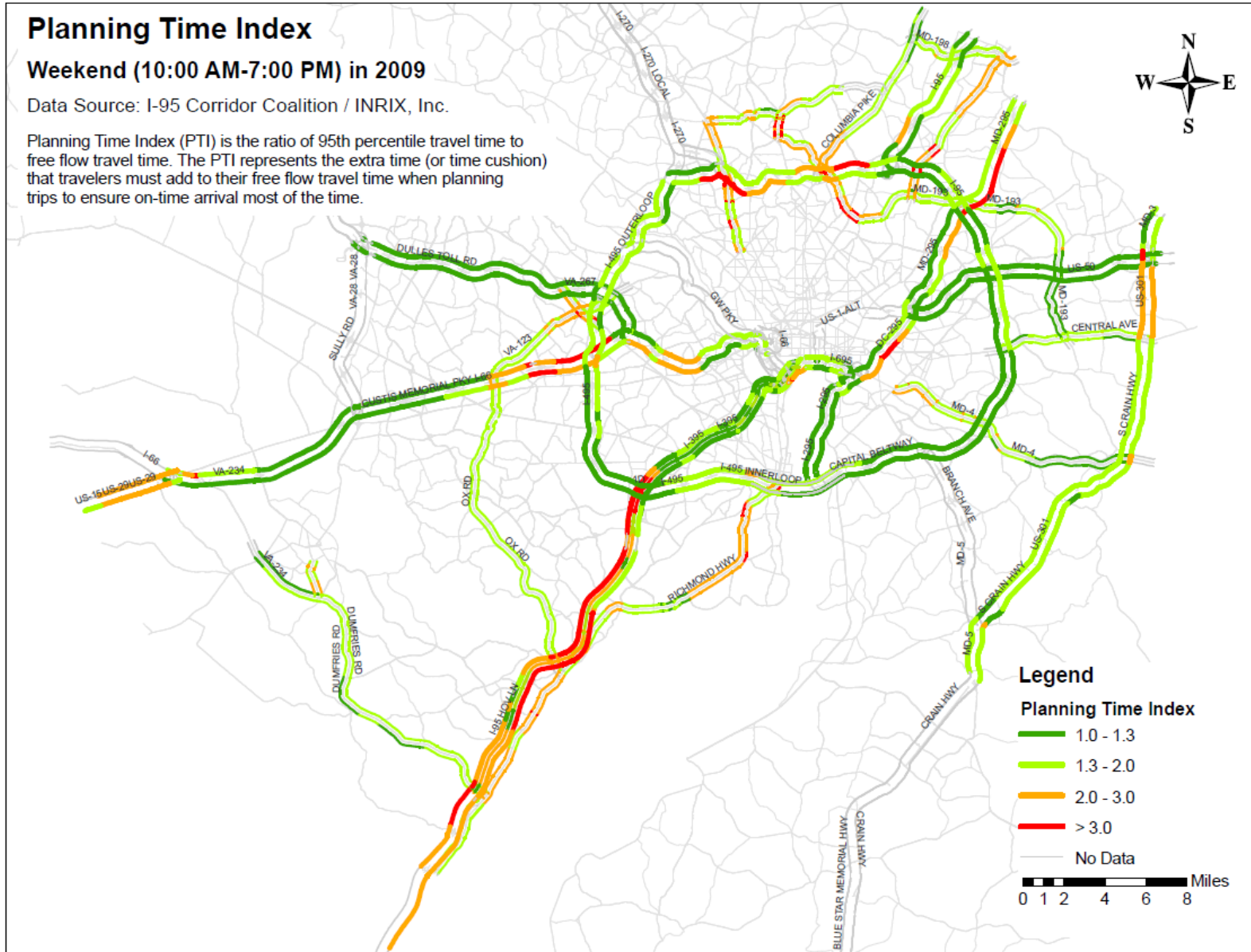

Figure D6: Planning Time Index: 2009 Workday Morning 6:00-7:00 AM for the I-95 Corridor Coalition Covered Highways

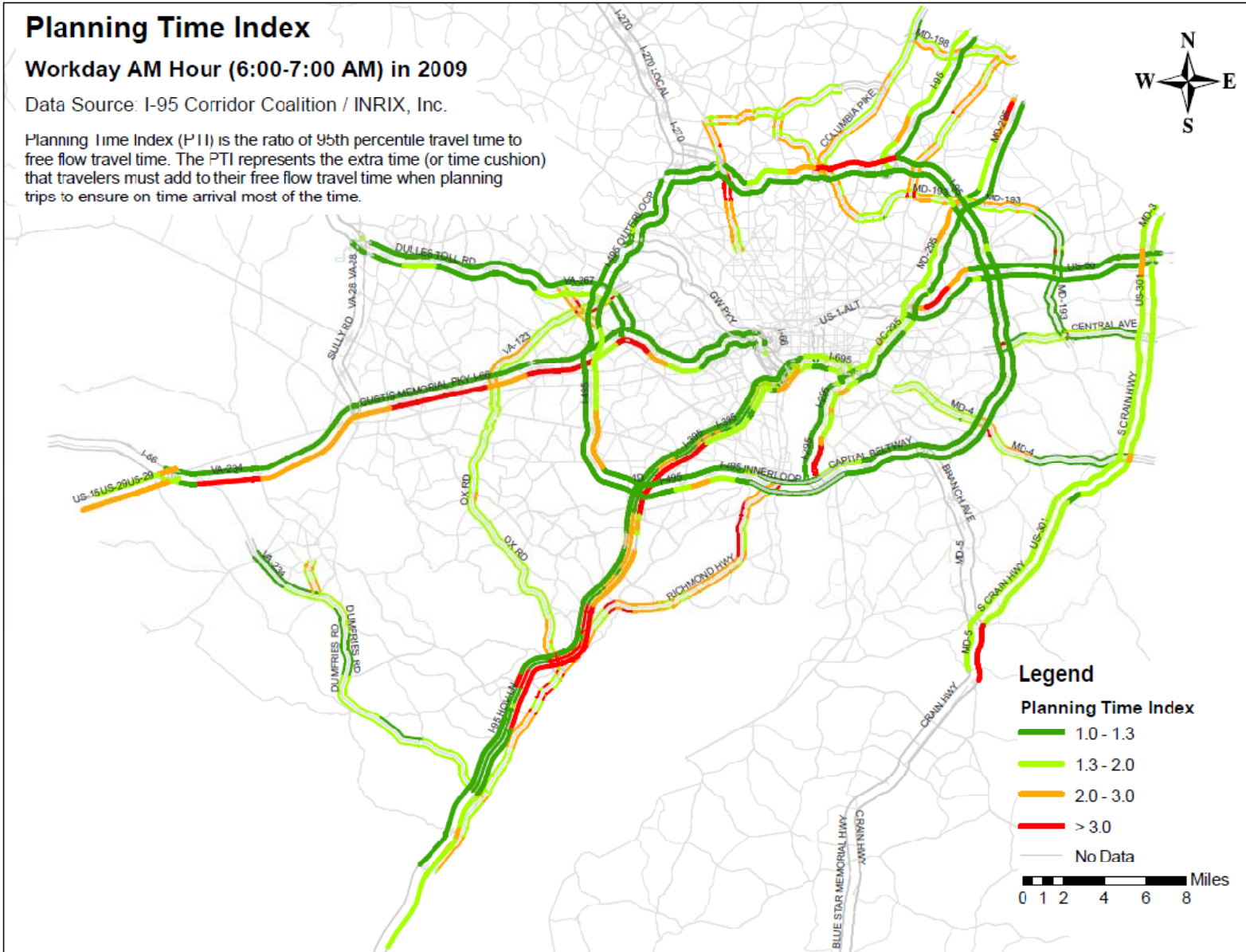

Figure D9: Planning Time Index: 2009 Workday Morning 9:00-10:00 AM for the I-95 Corridor Coalition Covered Highways

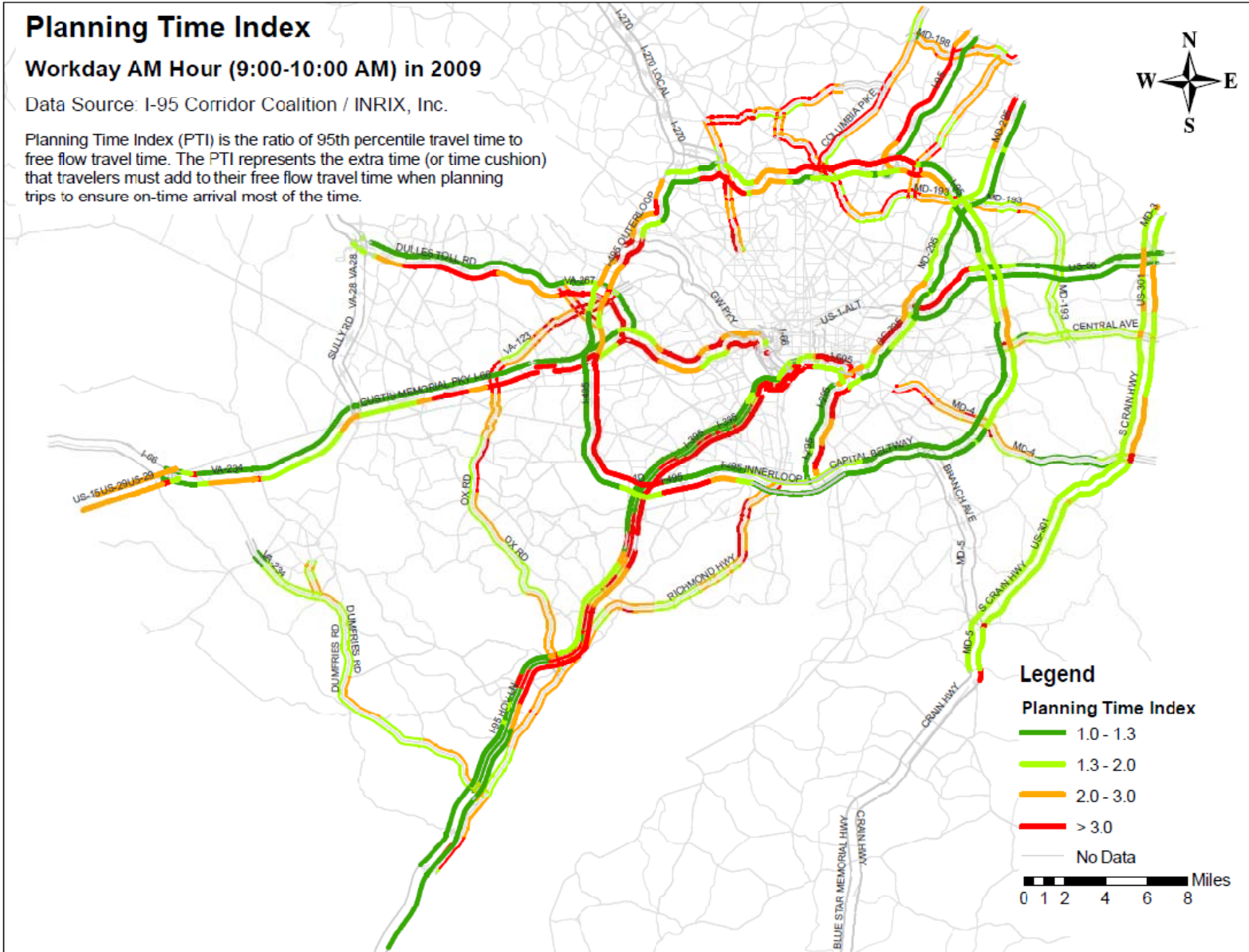

Figure D10: Planning Time Index: 2009 Workday Afternoon 3:00-4:00 PM for the I-95 Corridor Coalition Covered Highways

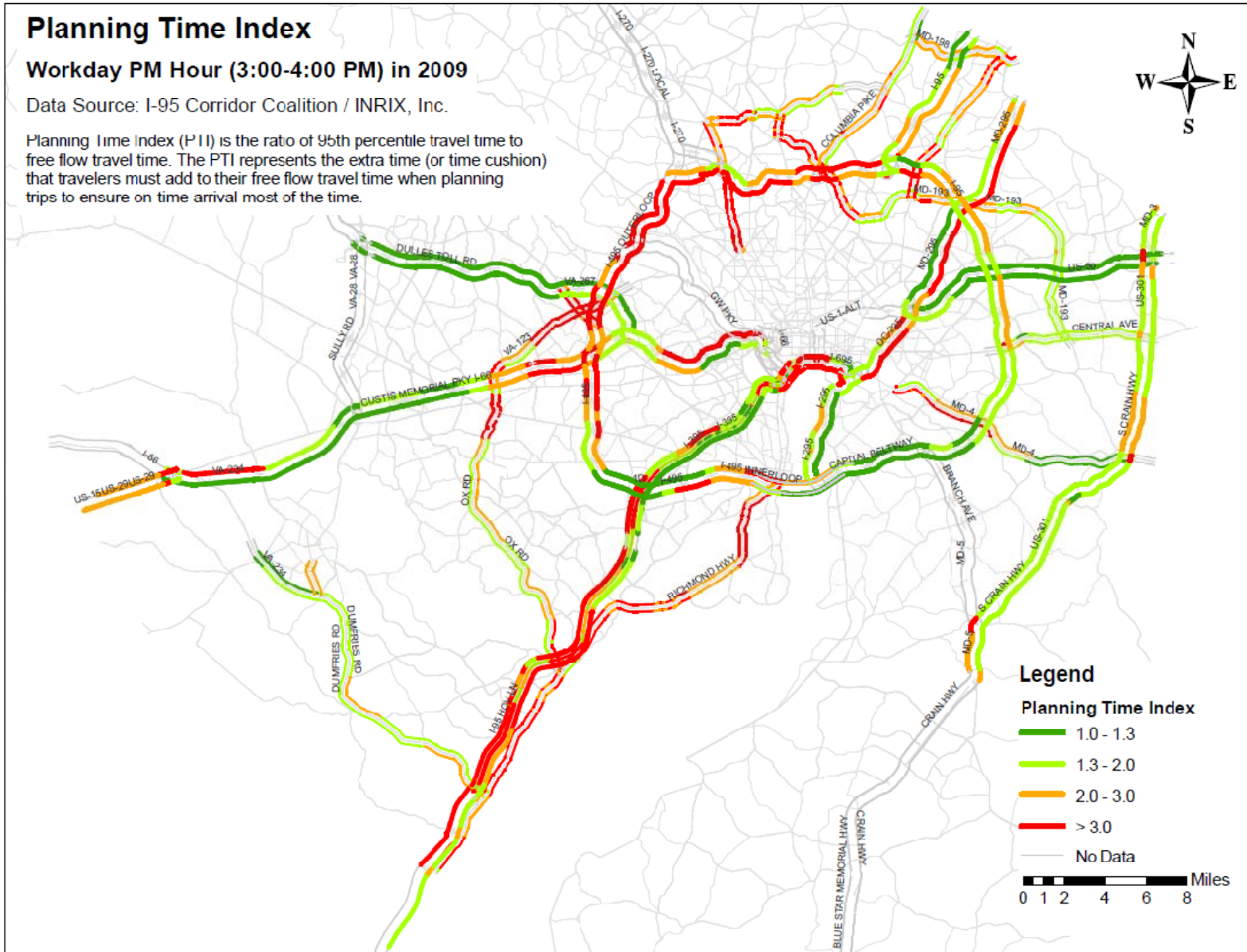

Figure D11: Planning Time Index: 2009 Workday Afternoon 4:00-5:00 PM for the I-95 Corridor Coalition Covered Highways

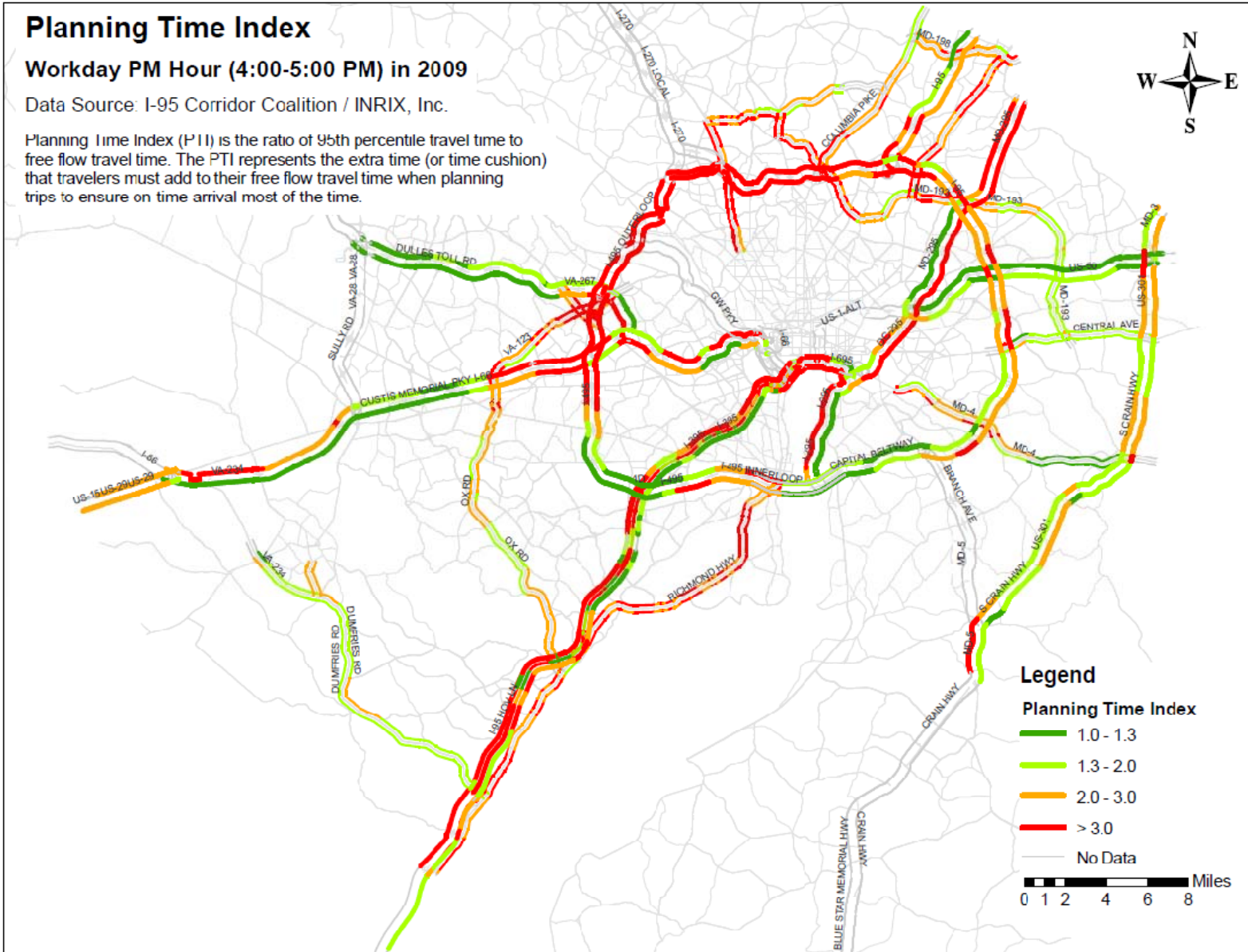

Figure D12: Planning Time Index: 2009 Workday Afternoon 5:00-6:00 PM for the I-95 Corridor Coalition Covered Highways

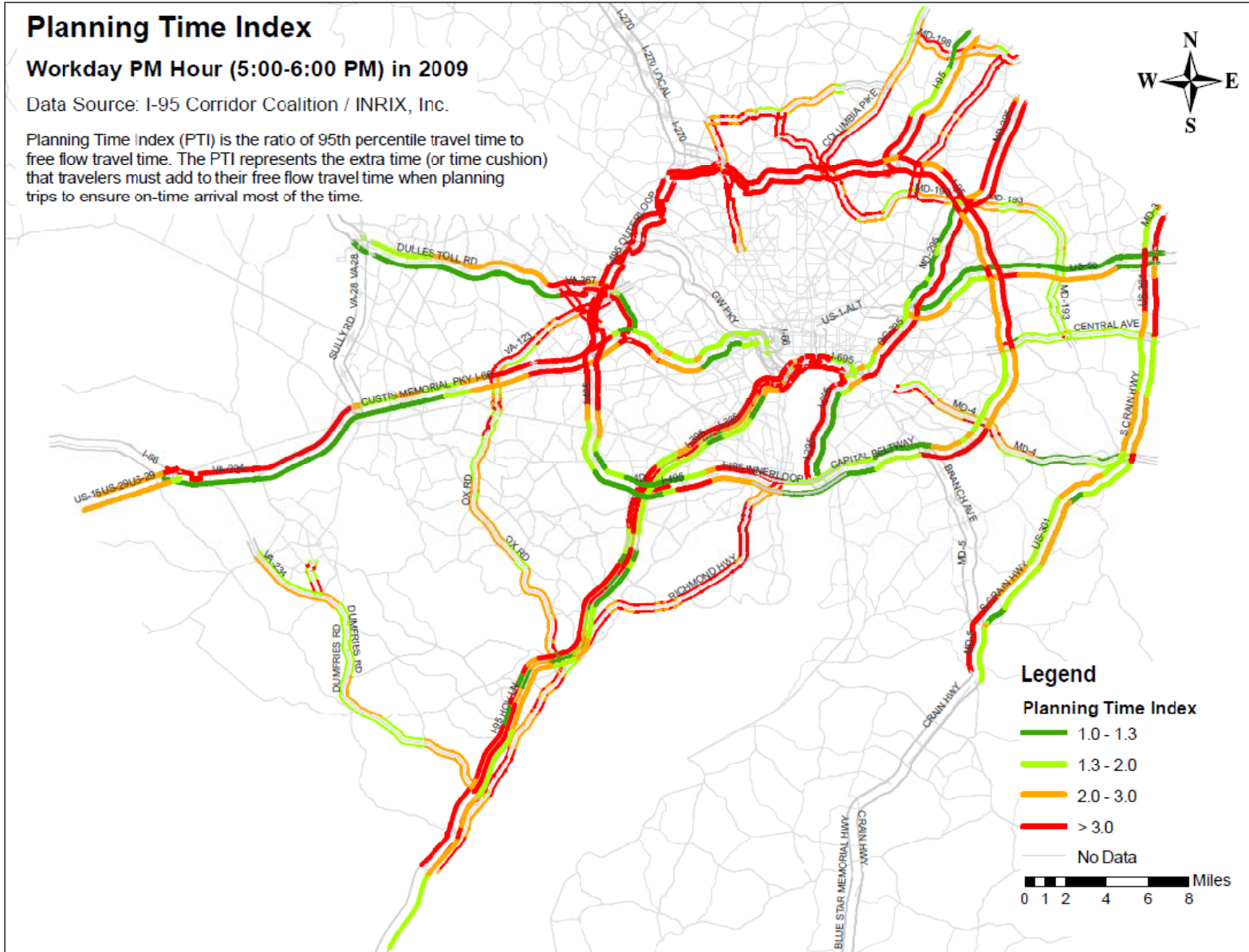
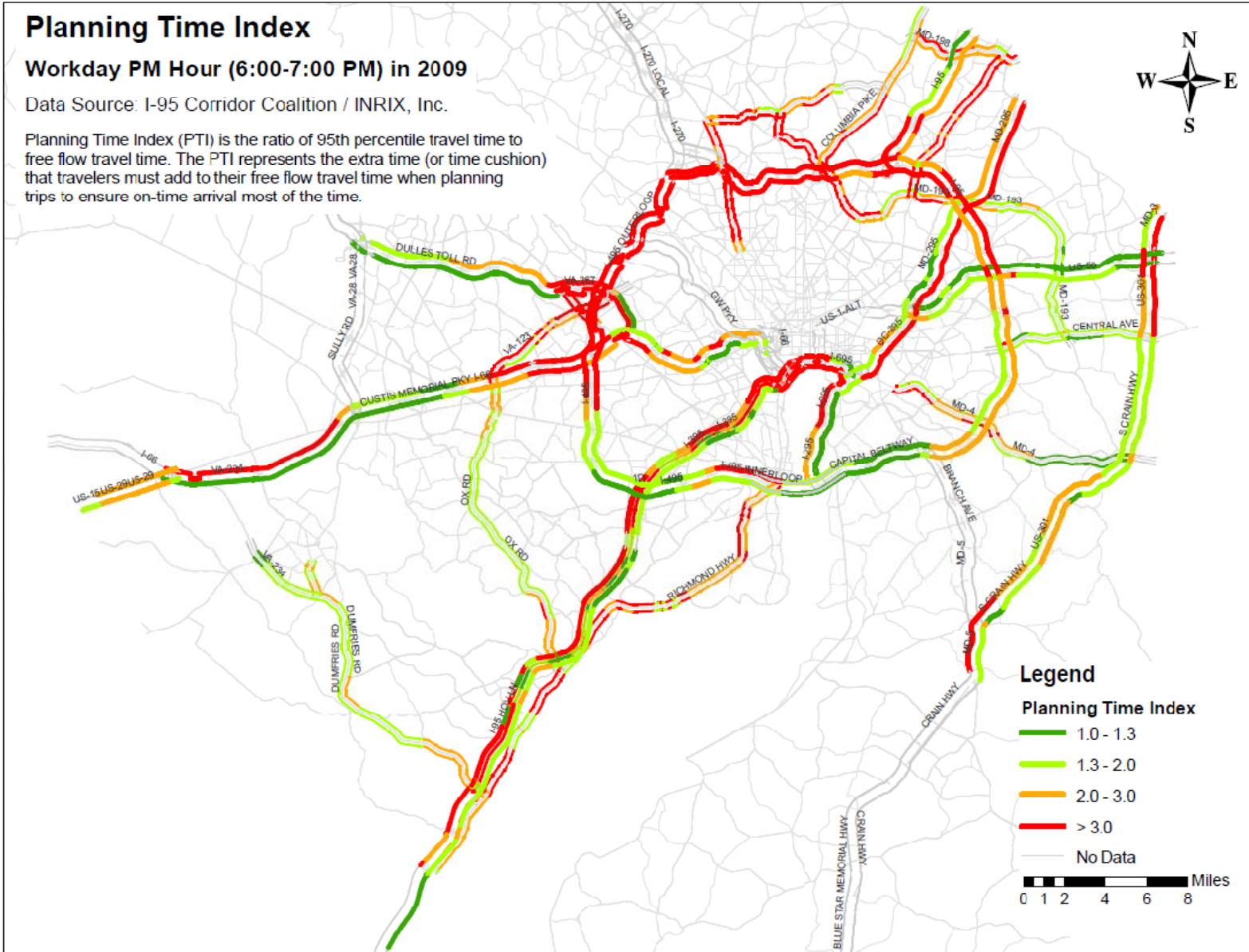

Figure D13: Planning Time Index: 2009 Workday Afternoon 6:00-7:00 PM for the I-95 Corridor Coalition Covered Highways



**APPENDIX E – BUFFER TIME INDEX OF THE I-95 CORRIDOR COALITION VEHICLE
PROBE PROJECT COVERED HIGHWAYS IN THE TPB MEMBER JURISDICTIONS**

(Blank)

Figure E1: Buffer Time Index: 2009 All Time (24/7/365) for the I-95 Corridor Coalition Covered Highways

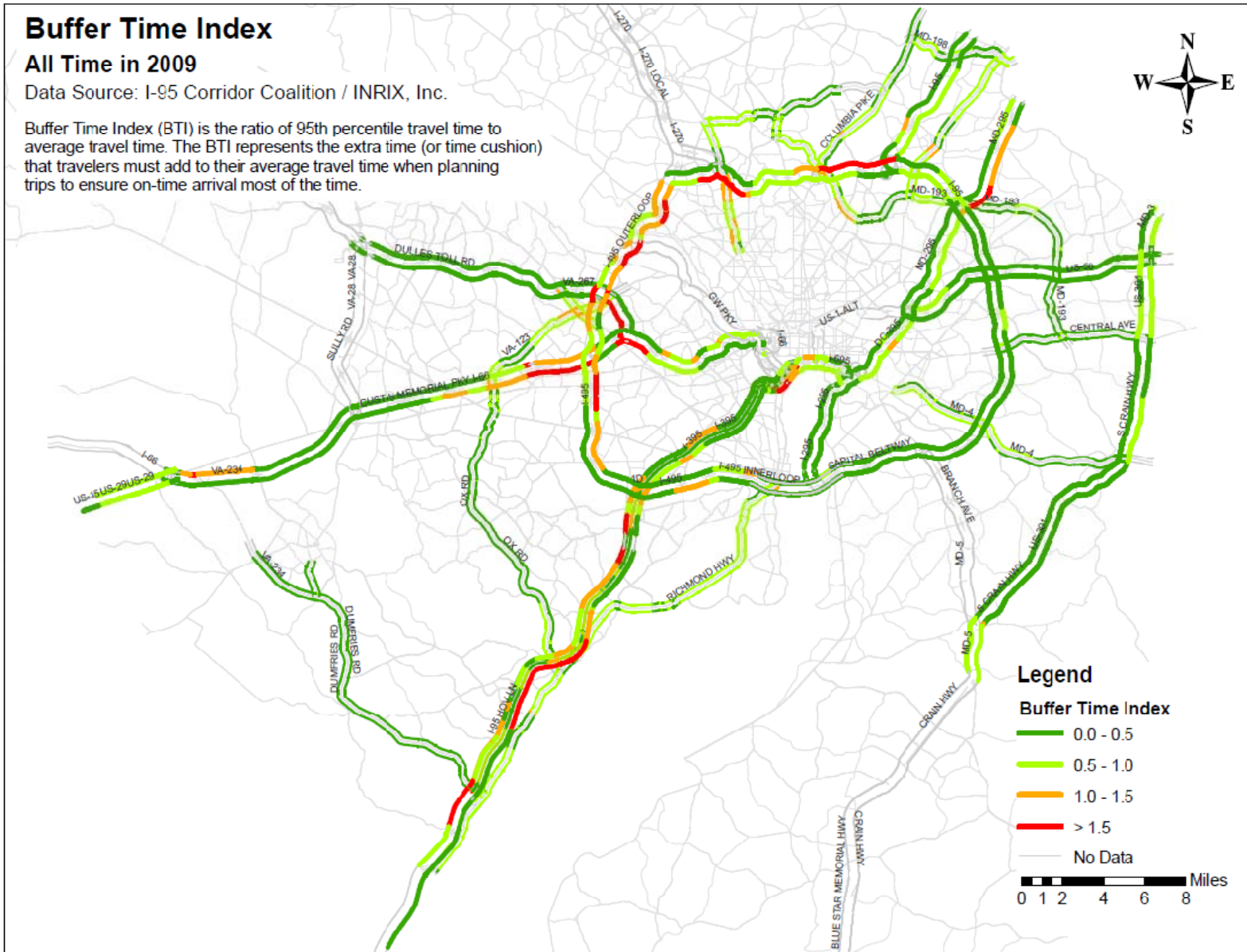

Figure E2: Buffer Time Index: 2009 Workday AM Peak (6:00-10:00 AM) for the I-95 Corridor Coalition Covered Highways

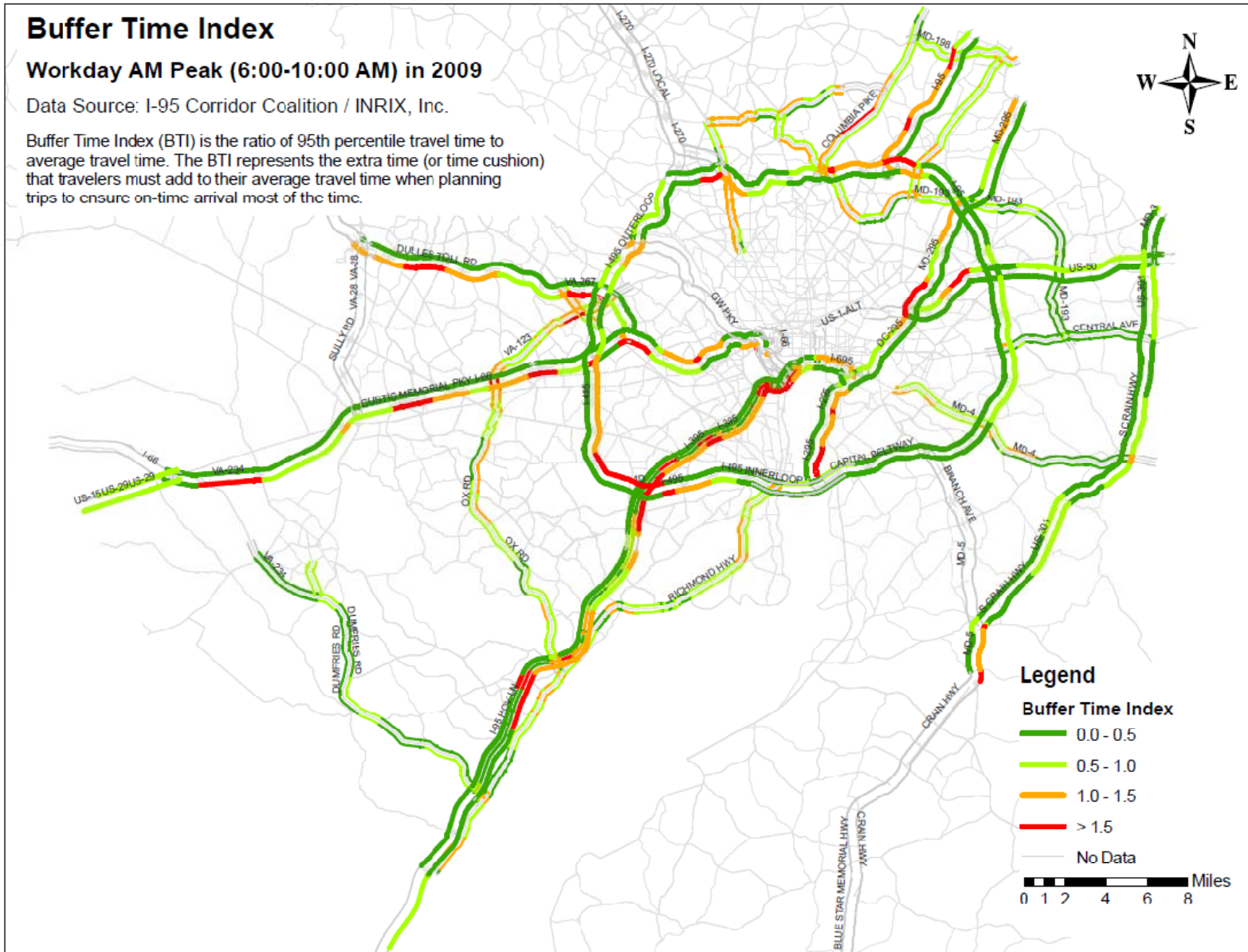

Figure E4: Buffer Time Index: 2009 Workday Midday 10:00 AM - 3:00 PM for the I-95 Corridor Coalition Covered Highways

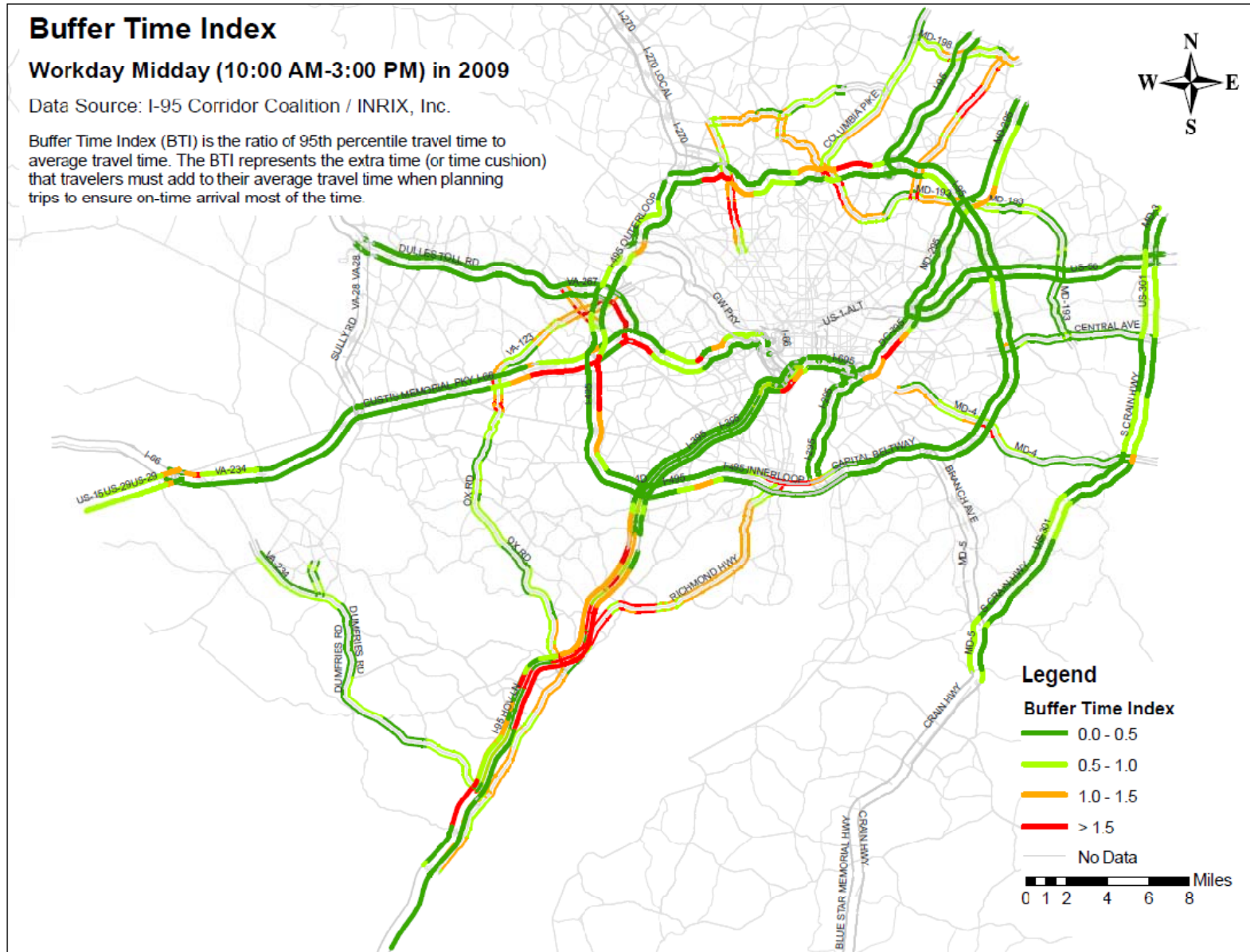

Figure E5: Buffer Time Index: 2009 Weekend 10:00 AM - 7:00 PM for the I-95 Corridor Coalition Covered Highways

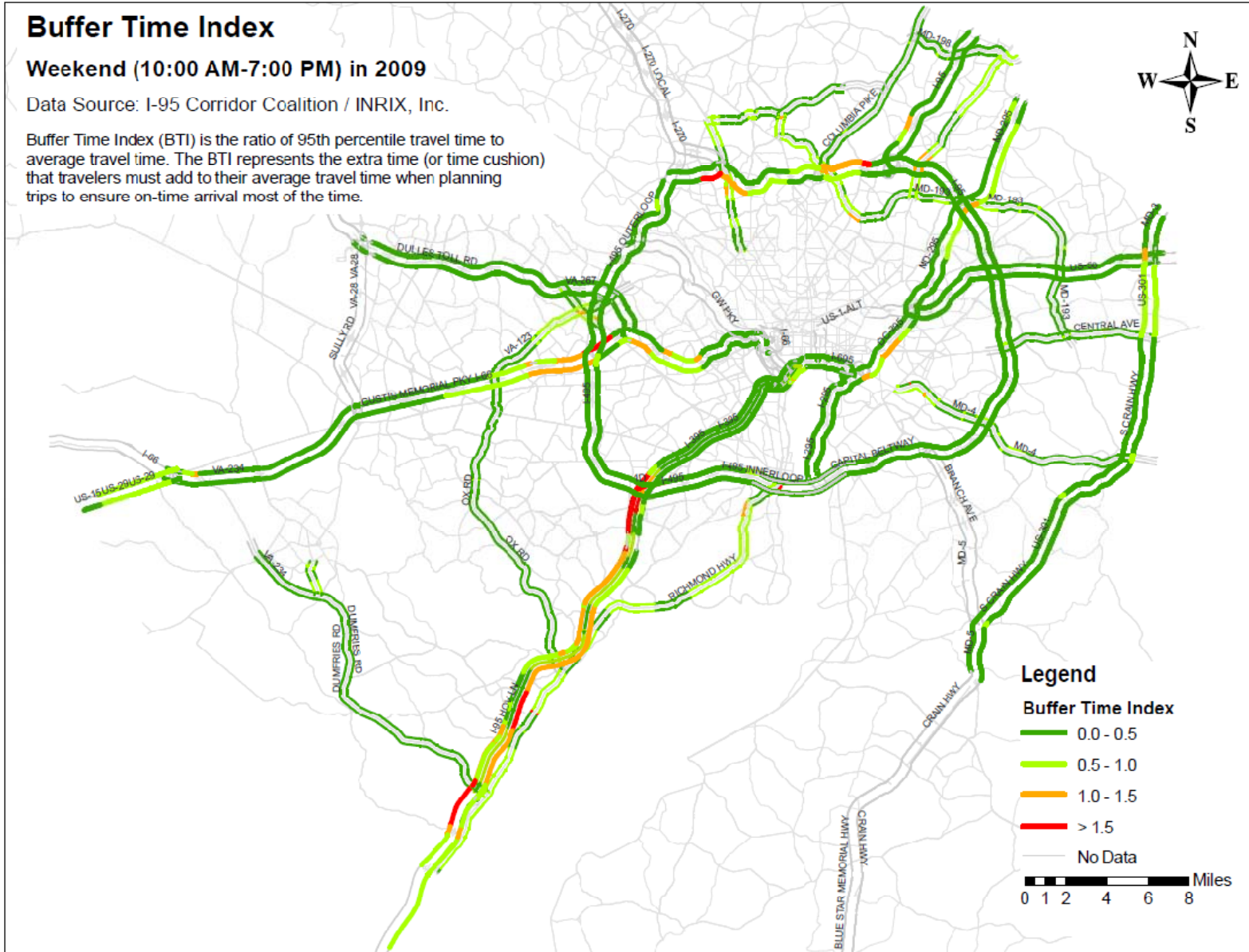

Figure E6: Buffer Time Index: 2009 Workday Morning 6:00-7:00 AM for the I-95 Corridor Coalition Covered Highways

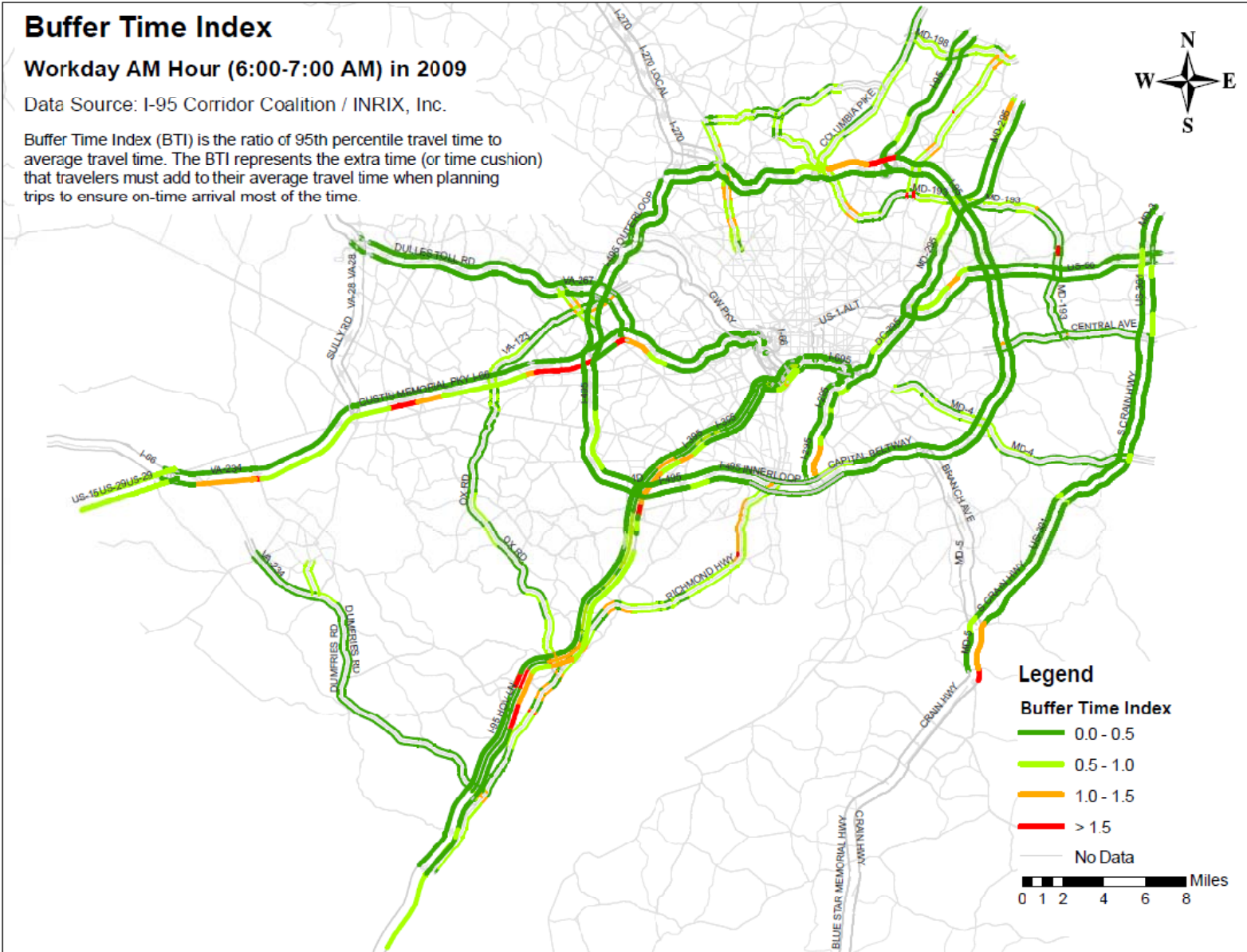

Figure E7: Buffer Time Index: 2009 Workday Morning 7:00-8:00 AM for the I-95 Corridor Coalition Covered Highways

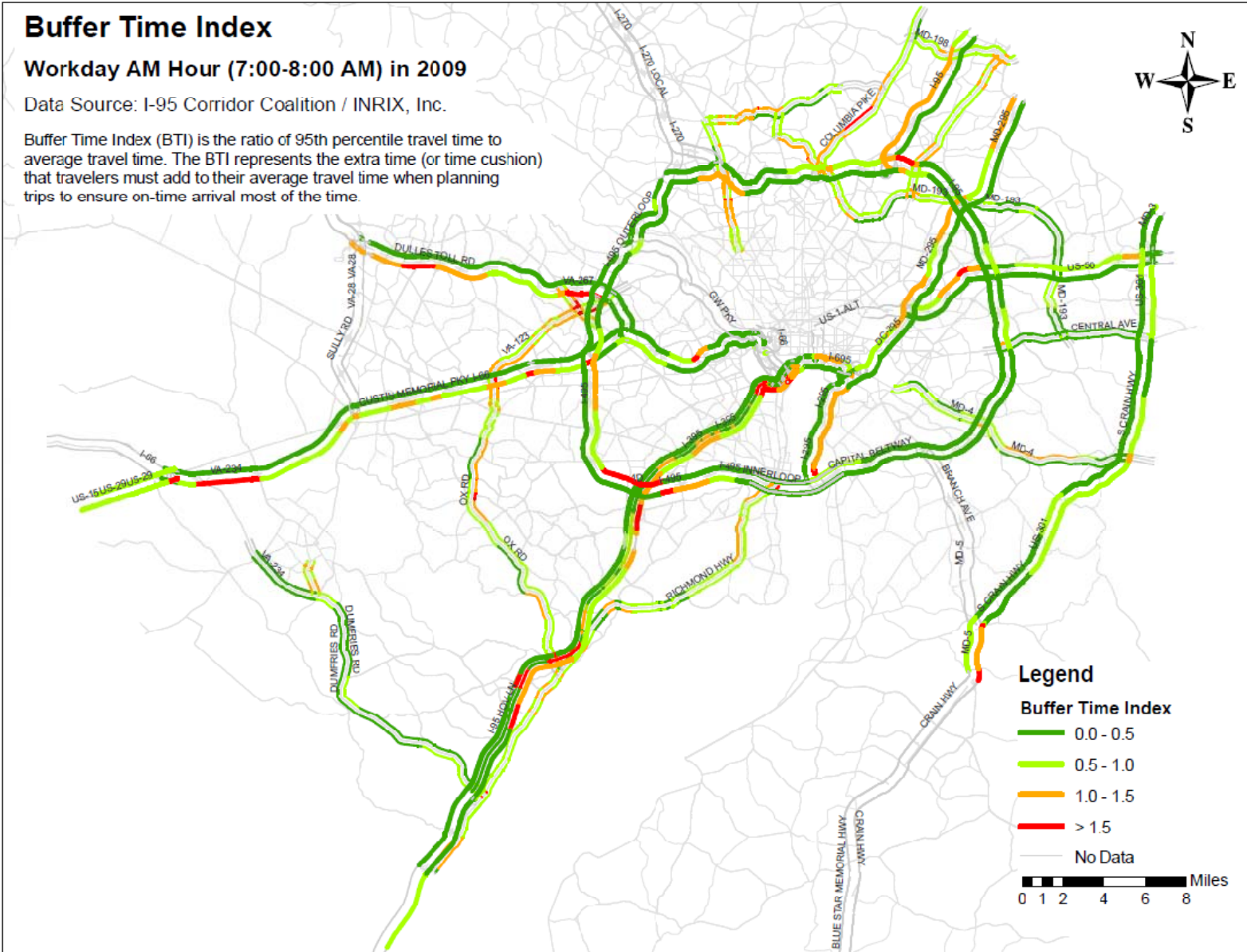

Figure E8: Buffer Time Index: 2009 Workday Morning 8:00-9:00 AM for the I-95 Corridor Coalition Covered Highways

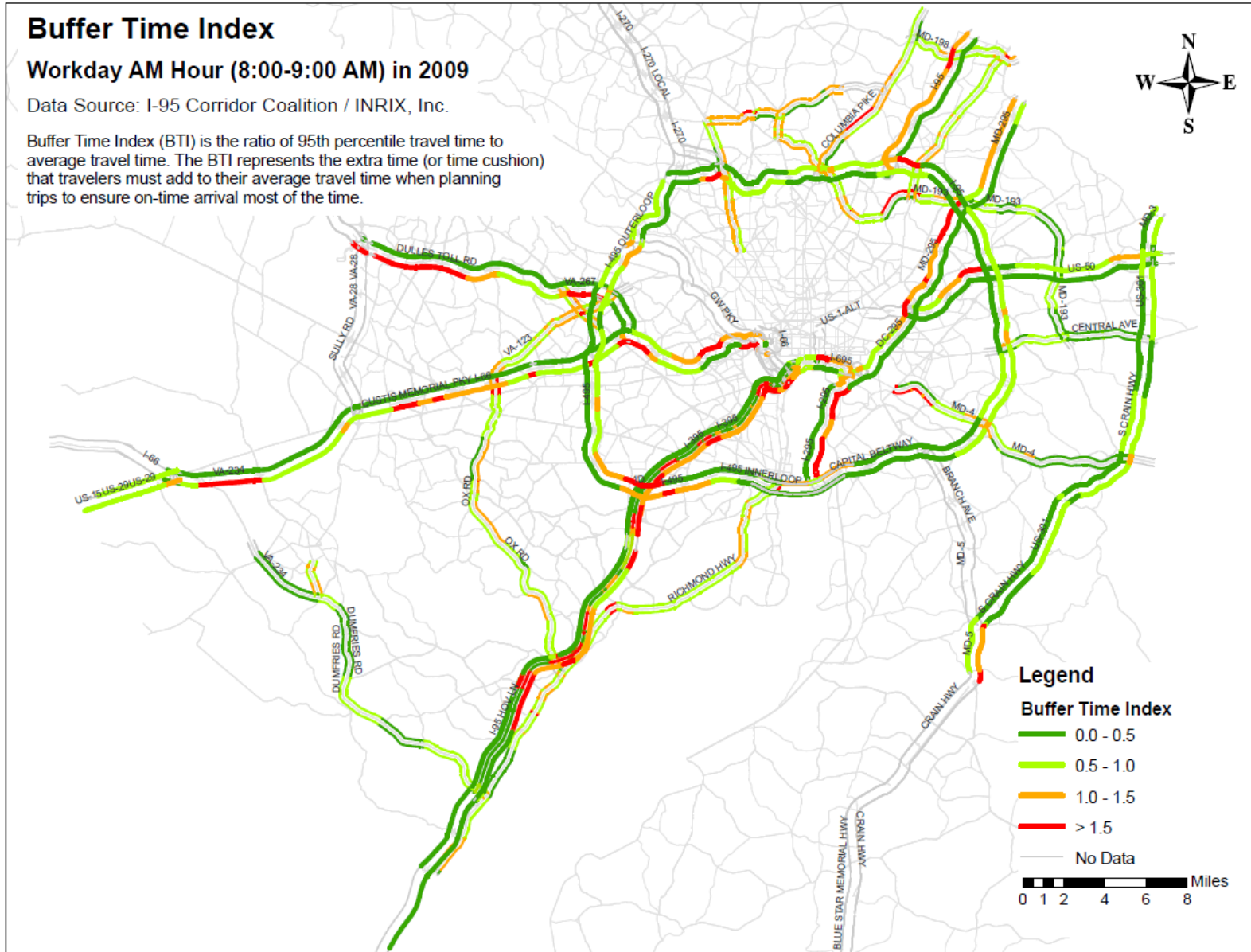

Figure E9: Buffer Time Index: 2009 Workday Morning 9:00-10:00 AM for the I-95 Corridor Coalition Covered Highways

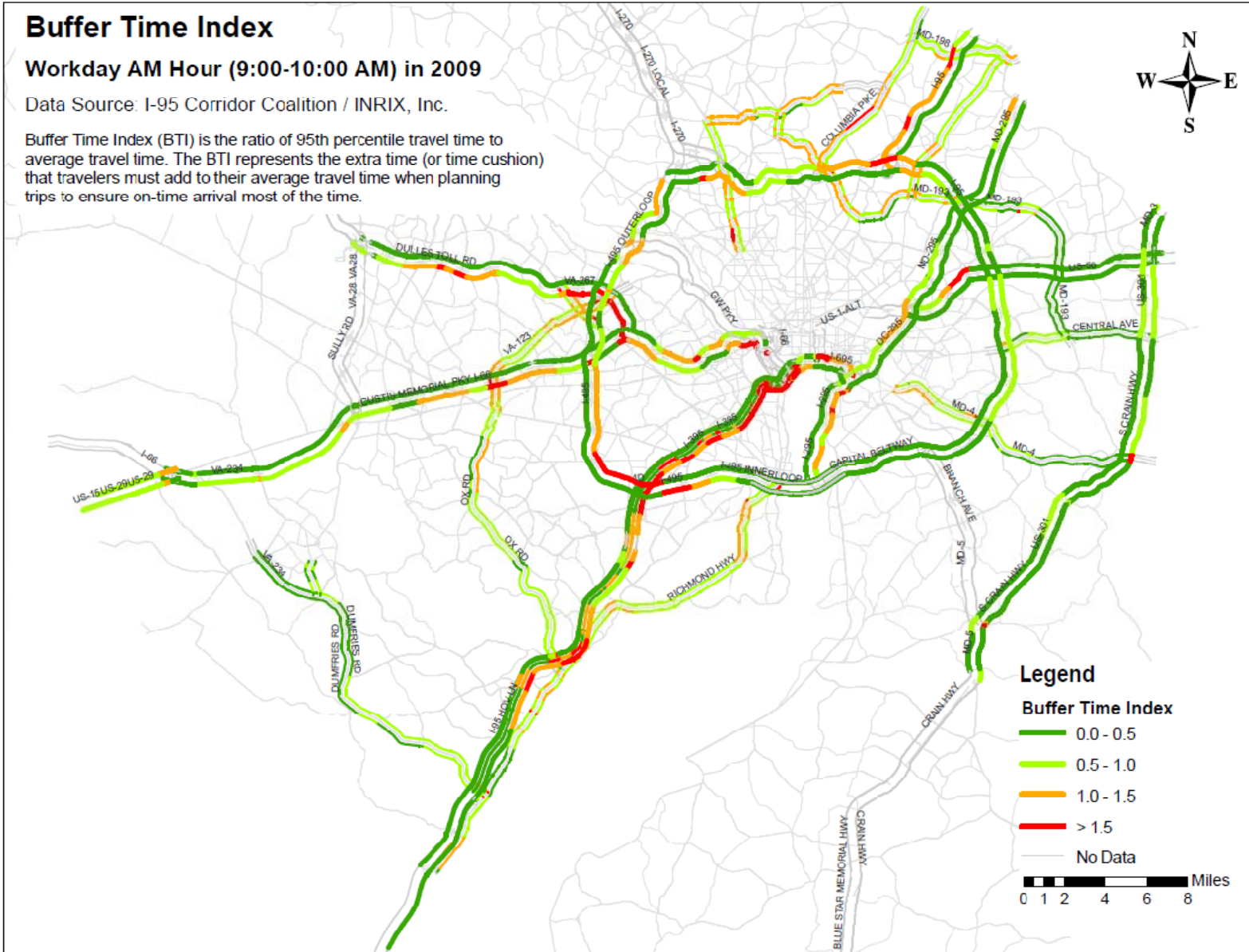

Figure E10: Buffer Time Index: 2009 Workday Afternoon 3:00-4:00 PM for the I-95 Corridor Coalition Covered Highways

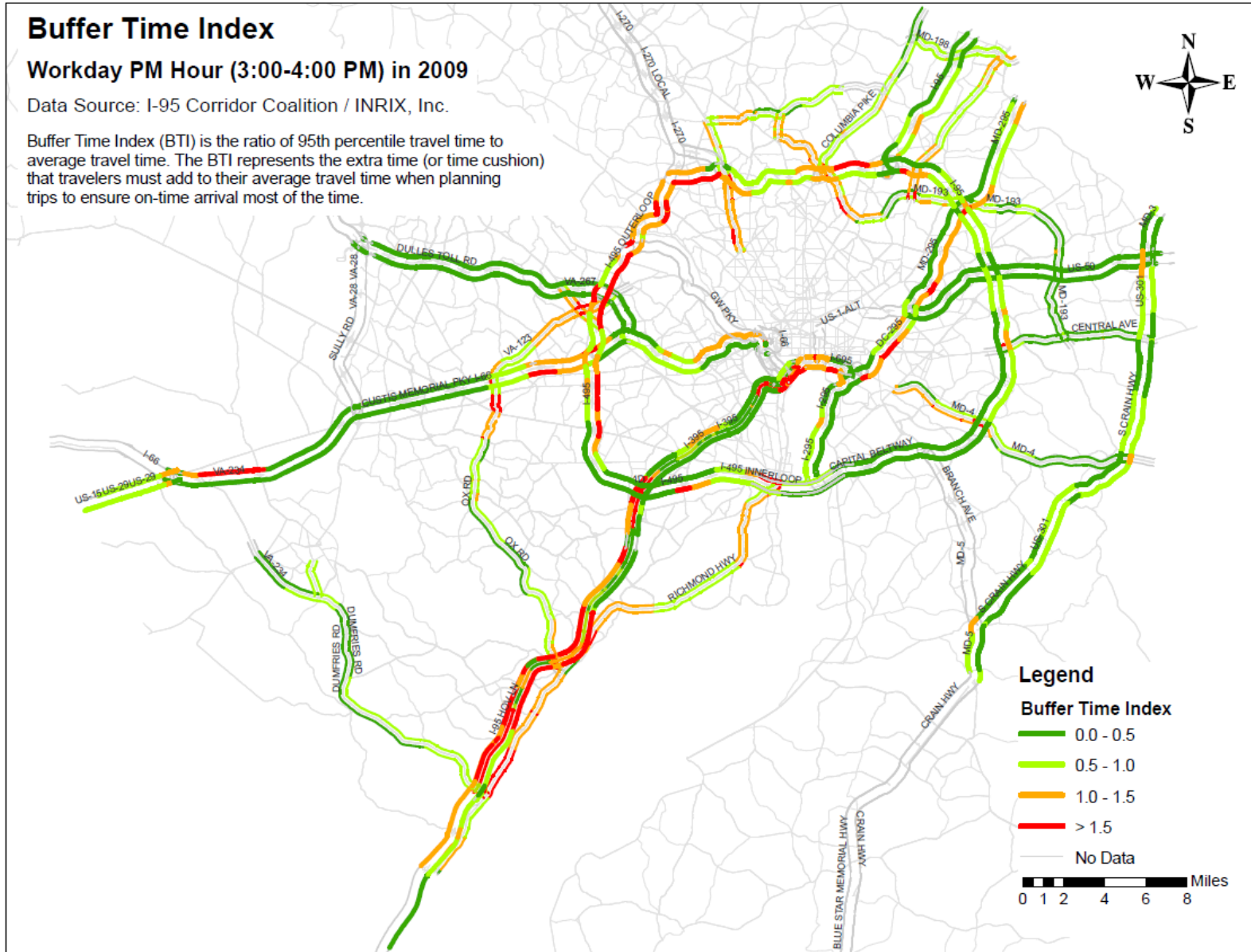
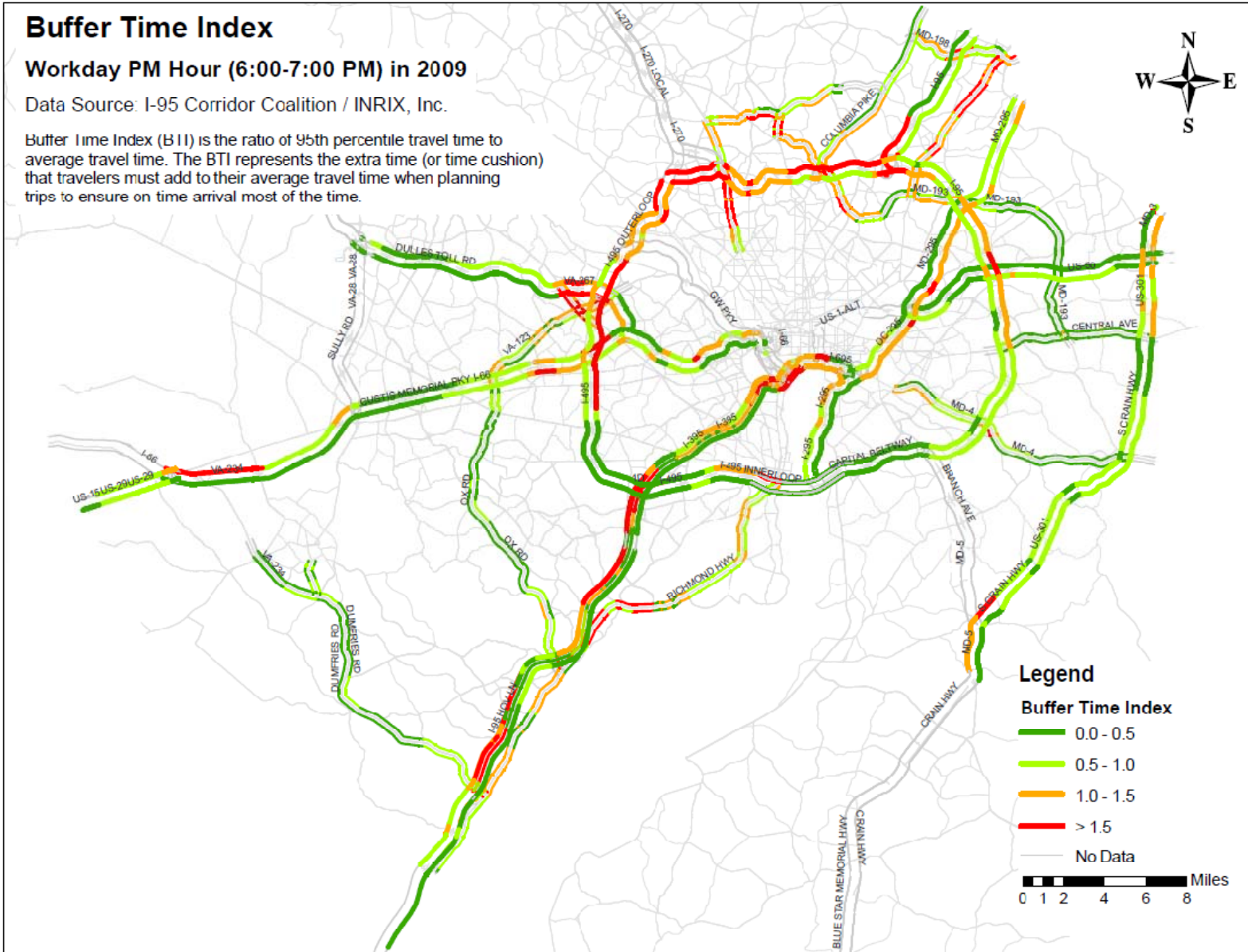

Figure E13: Buffer Time Index: 2009 Workday Afternoon 6:00-7:00 PM for the I-95 Corridor Coalition Covered Highways



APPENDIX F – SHA RIDESHARING FACILITY STATISTICS

SPRING 2001 RIDESHARING INVENTORY BY COUNTY				
COUNTY	LOTS	SPACES	PATRONS	AVG. % USE
ANNE ARUNDEL	8	1386	842	61%
CALVERT	7	314	310	99%
FREDERICK	7	847	354	42%
HOWARD	8	1760	744	42%
MONTGOMERY	1	248	13	5%
PRINCE GEORGES	4	419	274	65%
TOTALS	35	4974	2537	51%

2005 RIDESHARING INVENTORY BY COUNTY				
COUNTY	LOTS	SPACES	PATRONS	AVG. % USE
ANNE ARUNDEL	8	1386	1170	84%
CALVERT	7	310	277	89%
FREDERICK	8	863	514	60%
HOWARD	9	1760	888	50%
MONTGOMERY	3	1019	252	25%
PRINCE GEORGES	4	868	333	38%
TOTALS	39	6,206	3,434	55%

2006 RIDESHARING INVENTORY BY COUNTY				
COUNTY	LOTS	SPACES	PATRONS	AVG. % USE
ANNE ARUNDEL	8	1586	1200	76%
CALVERT	7	362	316	87%
FREDERICK	8	863	525	61%
HOWARD	8	1833	1000	55%
MONTGOMERY	3	1019	311	31%
PRINCE GEORGES	4	868	358	41%
TOTALS	38	6,531	3,710	57%

2007 RIDESHARING INVENTORY BY COUNTY				
COUNTY	LOTS	SPACES	PATRONS	AVG. % USE
ANNE ARUNDEL	8	1586	1225	77%
CALVERT	7	312	297	95%
FREDERICK	8	902	517	57%
HOWARD	8	1833	1041	57%
MONTGOMERY	3	1019	255	25%
PRINCE GEORGES	4	840	354	42%
TOTALS	38	6,492	3,689	57%

APPENDIX G – 2006 CENTRAL EMPLOYMENT AREA CORDON COUNT GRAPHIC

Figure G1: 2006 Central Employment Area Cordon Count, Person Trips – Modal Share Trends 1996-2006, Inbound 6:30-9:30 A.M.

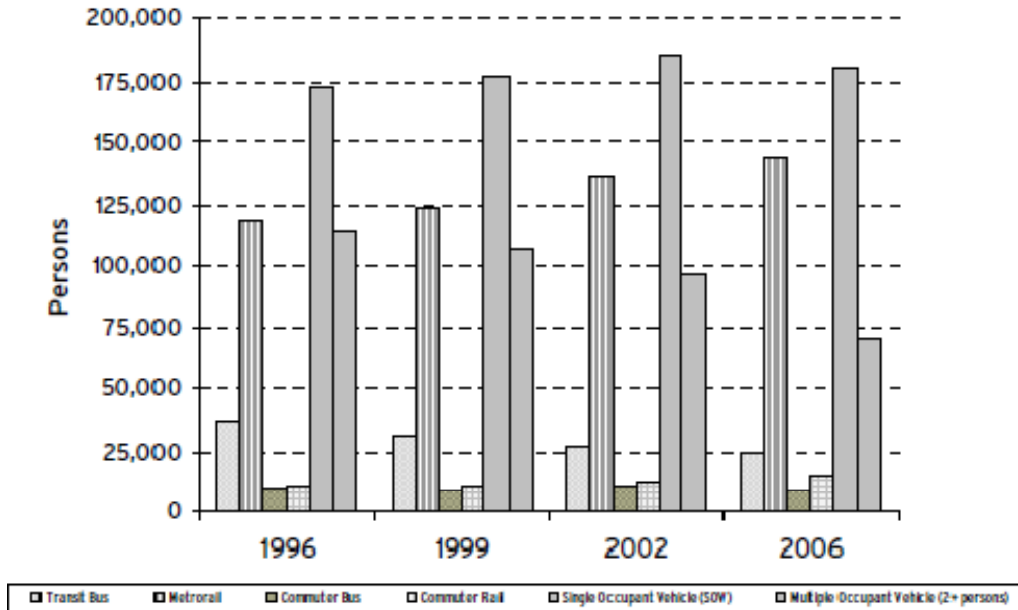
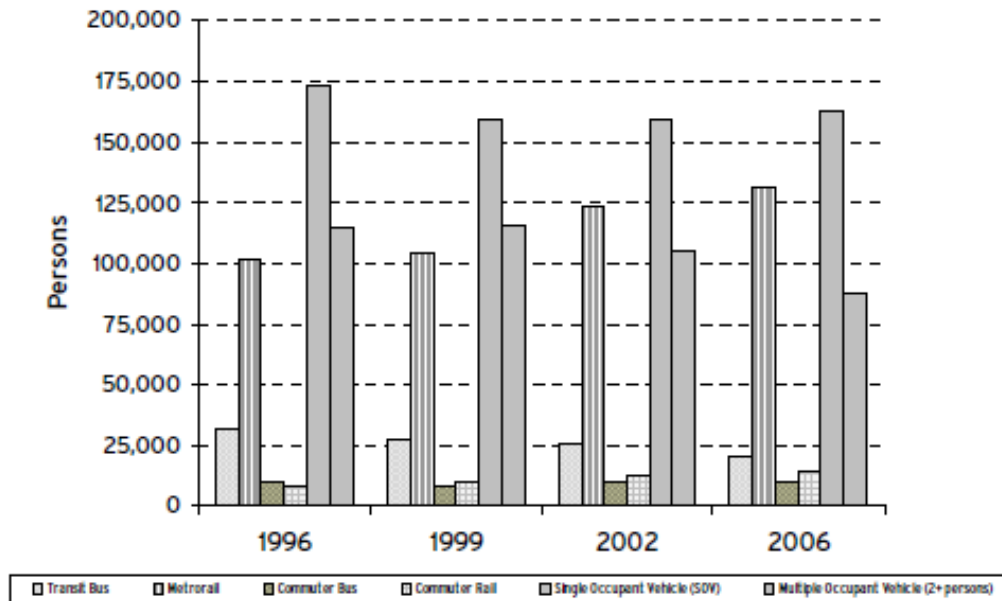

Figure G2: 2006 Central Employment Area Cordon Count, Person Trips – Modal Share Trends 1996-2006, Outbound 3:30-6:30 A.M.



APPENDIX H – 2003 DC CORDON COUNT STUDY GRAPHIC

Figure H1: Inbound Peak Period Trips by Mode of 2003 D.C. City Line Cordon Count

2003 D.C. City Line Cordon Count
Inbound Peak Period Trips by Mode
6:30 A.M. - 9:30 A.M.
1990, 1998 and 2003

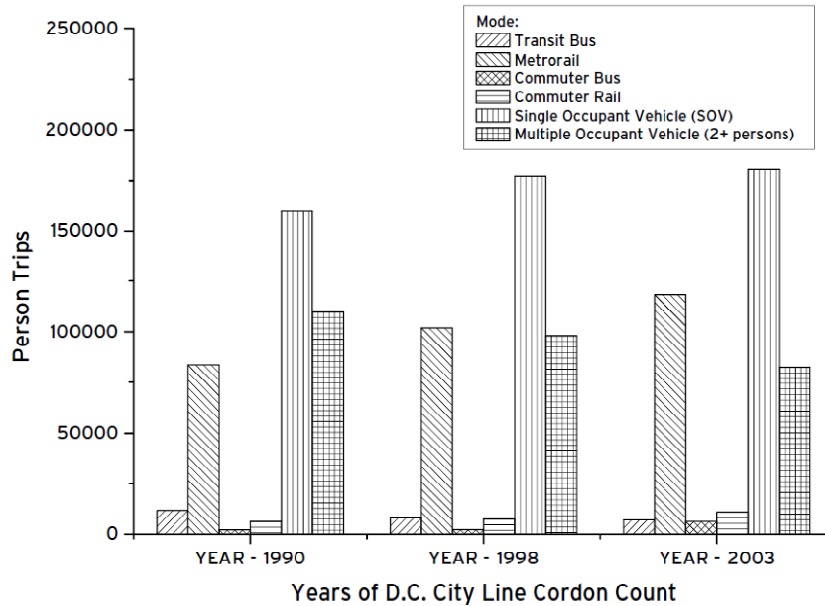
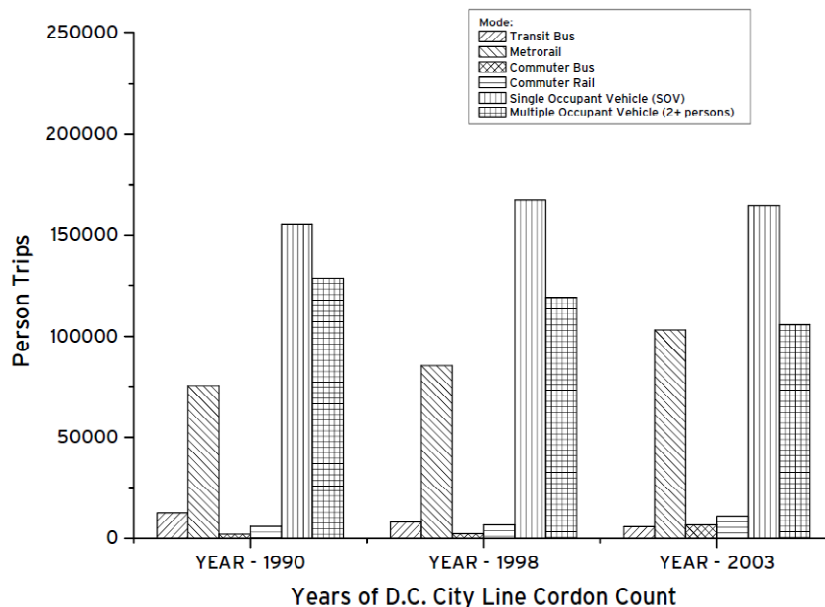

Figure H2: Outbound Peak Period Trips by Mode of 2003 D.C. City Line Cordon Count

2003 D.C. City Line Cordon Count
Outbound Peak Period Trips by Mode
3:30 P.M. - 6:30 P.M.
1990, 1998 and 2003



APPENDIX I – SUMMARY OF DAILY IMPACT RESULTS FOR INDIVIDUAL TERMS (7/05– 6/08) AND COMPARISON TO GOALS

Table II: Summary of Daily Impact Results for Individual TERMS (7/05– 6/08) and Comparison to Goals

TERM	Participation ¹⁾	Daily Vehicle Trips Reduced	Daily VMT Reduced	Daily Tons NO _x Reduced	Daily Tons VOC Reduced
Maryland and Virginia Telework ²⁾					
2008 Goal		11,830	241,208	0.122	0.072
Impacts (7/05 – 6/08)	49,027	21,866	413,703	0.211	0.126
Net Credit or (Deficit)		10,036	172,495	0.089	0.054
Guaranteed Ride Home					
2008 Goal	36,992	12,593	355,135	0.177	0.097
Impacts (7/05 – 6/08)	25,164	8,680	227,428	0.106	0.056
Net Credit or (Deficit)	(11,828)	(3,913)	(127,707)	(0.071)	(0.041)
Employer Outreach – all employers participating ³⁾					
2008 Goal	581	64,644	1,065,851	0.549	0.343
Impacts (7/05 – 6/08)	852	59,163	969,174	0.443	0.266
Net Credit or (Deficit)	271	(5,481)	(96,677)	(0.106)	(0.077)
Employer Outreach – new / expanded employer services since July 2005 ³⁾					
2008 Goal	96	8,618	140,622	0.072	0.046
Impacts (7/05 – 6/08)	194	22,510	372,406	0.178	0.102
Net Credit or (Deficit)	98	13,892	231,784	0.106	0.056
Employer Outreach for Bicycling ³⁾					
2008 Goal	61	130	567	0.001	0.001
Impacts (7/05 – 6/08)	122	188	1,127	0.001	0.001
Net Credit or (Deficit)	61	58	560	0.000	0.000
Mass Marketing					
2008 Goal	11,023	7,758	141,231	0.072	0.044
Impacts (7/05 – 6/08)	5,464	2,577	69,274	0.032	0.017
Net Credit or (Deficit)	(5,559)	(5,181)	(71,957)	(0.040)	(0.027)
InfoExpress Kiosks ⁴⁾					
2008 Goal		1,778	46,755	0.023	0.013
Impacts (7/05 – 6/08)	8,627	2,840	52,638	0.027	0.016
Net Credit or (Deficit)		1,062	5,883	0.004	0.003

- 1) Participation refers to number of commuters participating, except for the Employer Outreach TERM. For this TERM, participation equals the number of employers participating.
- 2) Impact represents portion of regional telecommuting attributable to TERM-related activities. Total telecommuting credited for conformity is higher than reported for the TERM.
- 3) Impacts for Employer Outreach - all employers participating includes impacts for Employer Outreach – new / expanded employer services since July 2005 and for Employer Outreach for Bicycling.
- 4) InfoExpress Kiosks TERM is part of the Integrated Rideshare TERM.

APPENDIX J – PEAK DIRECTION TRAVEL TIME SUMMARY FOR HOV AND NON-HOV LANES

Table K1: A.M. Peak Direction Travel Time Summary for HOV and non-HOV Lanes

Facility	Facility Section	Length (miles)	HOV		Non-HOV		Time Savings	
			Time(min)	Time(min)	Time(min)	Time(min)	in Minutes	in Min./Mi.
I-95/I-395	From Va.619 to the Pentagon	28.1	29	66	37	1.3		
	Outside Beltway	18.4	17	43	26	1.4		
	Inside Beltway	9.7	12	23	11	1.1		
I 66	From Va.234 to TR Bridge	27.8	53	70	17	0.6		
	Outside Beltway	17.3	37	38	1	0.1		
	Inside Beltway	10.5	16	31	15	1.4		
I-270	From I-370 to MD 187 (E.Spur)	8.8	13	19	6	0.7		
	From I-370 to Democracy (W.Spur)	8.6	14	22	8	0.9		
Va. 267	From Va.28 to TR Bridge	23.4	28	48	20	0.9		
	Va. 267 only	14.9	12	15	3	0.2		
US 50	From US 301 to MD 410	9.0	9	12	3	0.3		

Table K2: P.M. Peak Direction Travel Time Summary for HOV and non-HOV Lanes

Facility	Facility Section	Length (miles)	HOV		Non-HOV		Time Savings	
			Time(min)	Time(min)	Time(min)	Time(min)	in Minutes	in Min./Mi.
I-95/I-395	From Pentagon to Va.619	28.4	25	53	28	1.0		
	Outside Beltway	17.1	16	36	20	1.2		
	Inside Beltway	10.1	9	17	8	0.8		
I-66	From TR Bridge to Va. 234	27.9	34	56	22	0.8		
	Outside Beltway	17.1	22	34	12	0.7		
	Inside Beltway	10.4	12	22	10	1.0		
I-270	Md.187 (E.Spur) to Md.121	18.4	19	31	12	0.7		
	Democracy (W.Spur) to Md.121	18.1	20	28	8	0.4		
Va. 267	From TR Bridge to Va. 28	24.2	28	32	4	0.2		
	Va. 267 only	15.5	16	23	7	0.5		
US 50	From US 301 to MD 410	9.1	8	10	2	0.2		

APPENDIX K – SAMPLE CMP DOCUMENTATION FORM

Congestion Management Documentation Form for Projects in the 2030 CLRP



DRAFT

BASIC PROJECT INFORMATION

1. Agency: _____ Secondary Agency: _____

2. Project Title: **GENERIC TEMPLATE (SAMPLE)**

	Prefix	Route	Name	Modifier
4. Facility:				
5. From (_ at):				
6. To:				

7. Jurisdiction(s): _____

8. Indicate whether the proposed project's location is subject to or benefits significantly from any of the following in-place congestion management strategies:

- Metropolitan Washington Commuter Connections program (ridesharing, telecommuting, guaranteed ride home, employer programs)
- A Transportation Management Association is in the vicinity
- Channelized or grade-separated intersection(s) or roundabouts
- Reversible, turning, acceleration/deceleration, or bypass lanes
- High occupancy vehicle facilities or systems
- Transit stop (rail or bus) within a 1/2 mile radius of the project location
- Park-and-ride lot within a one-mile radius of the project location
- Real-time surveillance/traffic device controlled by a traffic operations center
- Motorist assistance/hazard clearance patrols
- Interconnected/coordinated traffic signal system
- Other in-place congestion management strategy or strategies (briefly describe below:)

This corridor also benefits from carsharing offered at transit stations and park-and-ride lots in the vicinity, which encourages people to leave their cars at home. In addition, there are extensive pedestrian connections in the area, including sidewalks and bicycle paths along this roadway. (Customize and/or add agency specifics...)

9. List and briefly describe how the following categories of (additional) strategies were considered as full or partial alternatives to single-occupant vehicle capacity expansion in the study or proposal for the project.

a. Transportation demand management measures, including growth management and congestion pricing

The status of and potential impacts of transportation demand management measures, including growth management and congestion pricing, have been considered for this corridor. The facility benefits from the regional alternative commute program, Commuter Connections, jointly funded by Virginia, Maryland, and the District of Columbia. Commuter Connections encourages ridesharing, teleworking, carpooling, vanpooling, and riding/biking to work, among other demand management measures. Additionally, the County promotes its own ridesharing program, providing a wealth of free information on commuting options, and promotes flexible/compressed workweeks. (Customize and/or add agency specifics...)

b. Traffic operational improvements

The status of and potential impacts of traffic operational improvements have been considered for this corridor. Feasible traffic operations management activities have been or will be implemented along the corridor, as well as traffic signal coordination. Strategies include those that aid in reducing non-recurring congestion. (Customize and/or add agency specifics...)

c. Public transportation improvements

The status of and potential impacts of feasible public transportation improvements have been considered for this corridor. Public transportation in the corridor includes regional bus and rail, along with locally-operated bus services. Park-and-Ride lots are also provided in the vicinity of the project. (Customize and/or add agency specifics...)

d. Intelligent Transportation Systems technologies

The status of and potential impacts of feasible Intelligent Transportation Systems (ITS) technologies have been considered for this corridor. ITS technologies providing traveler information and/or traffic management have been or will be implemented along the corridor. (Customize and/or add agency specifics...)

e. Other congestion management strategies

(Customize and/or add agency specifics...)

f. Combinations of the above strategies

The status of and potential impacts of feasible combinations of the above strategies have been considered for this corridor. The above strategies work together to reduce recurring and non-recurring congestion. (Customize and/or add agency specifics...)

10. Could congestion management alternatives fully eliminate or partially offset the need for the proposed increase in single-occupant vehicle capacity? Explain why or why not.

No. While the above congestion management alternatives help manage existing traffic flow on the corridor, additional capacity is needed. However, additional congestion management strategies will continue to be considered and implemented to help manage future capacity in the corridor. (Customize and/or add agency specifics...)

11. Describe all congestion management strategies that are going to be incorporated into the proposed highway project.

The following congestion management strategies (#9a,b,c,d,e,and/or f) will be implemented and improved upon, and/or additional feasible strategies will be considered... (Customize and/or add agency specifics...)

12. Describe the proposed funding and implementation schedule for the congestion management strategies to be incorporated into the proposed highway project. Also describe how the effectiveness of strategies implemented will be monitored and assessed after implementation.

Feasible congestion management strategies are or will be in place along the corridor, and will continue to be in place as the project is implemented, under funding identified within the project. Consideration will be given on how to enhance these existing strategies and to what extent feasible new strategies can be implemented. (Customize and/or add agency specifics...)

APPENDIX L – REVIEW OF CONGESTION MANAGEMENT STRATEGIES

This appendix references the tables 6 and 7 in **Section 4.2.2**, which are repeated on the next two pages for convenience.

GENERAL CHARACTERISTICS

Strategy Name and Number:

The strategies down the left-hand side of the lists were developed based on the types of strategies being pursued in the region and elsewhere, and could be considered for implementation in our region. Inclusion of any given strategy on the list does not imply endorsement, but rather is included on the list only for consideration and comparison purposes.

Each strategy has a number associated with it (C.1.0, C.1.1, etc.) to make it easier to find and discuss the strategies. The number is not in any way a ranking.

Those listed in bold italics are the strategy categories and underneath them are the specific strategies in that category.

Table L1: Congestion Management Process (CMP) Demand Management Strategies Criteria

STRATEGY		QUALITATIVE CRITERIA									
		Impacts on Congestion					Other Criteria				
		Reduces Overall Congestion	Reduces Incident-related Congestion	Supports/Promotes Multi-modal Transportation	Regional Applicability	Local Applicability	Existing Level of Deployment	Ease of Implementation	Cost	Cost Effectiveness	Enhance Existing Programs
C.5.0 Alternative Commute Programs											
C.5.1	Carpooling	xxx	x	x	xxx	xxx	xxx	xx	x	xxx	xxx
C.5.2	Ridematching Services	xxx	x	x	xxx	xxx	xxx	xx	x	xxx	xxx
C.5.3	Vanpooling	xxx	x	x	xxx	xx	xx	xx	x	xxx	xxx
C.5.4	Telecommuting	xx	x	x	xxx	xx	xx	xxx	x	xx	xxx
C.5.5	Promote Alternate Modes	xx	x	xxx	xxx	xxx	xxx	xxx	x	xx	xxx
C.5.6	Compressed/flexible work weeks	xx	x	x	xxx	xxx	xxx	xxx	x	x	xx
C.5.7	Employer outreach/mass marketing	xx	x	xxx	xxx	xxx	xx	xx	xx	xx	xxx
C.5.8	Parking cash-out	xx	x	xxx	x	xxx	x	x	xx	xx	x
C.5.9	Alternative Commute Subsidy Program	xx	x	xxx	xxx	xx	xx	x	x	xxx	xxx
C.6.0 Managed Facilities											
C.6.1	HOV	xx	x	xxx	xxx	xx	xx	xx	xxx	xxx	xxx
C.6.2	Variably Priced Lanes (VPL)	xxx	x	xx	xxx	xx	x	x	xxx	xxx	xx
C.6.3	Cordon Pricing	xxx	x	xxx	xxx	x	x	x	xx	xxx	xx
C.6.4	Bridge Tolling	xxx	x	x	xx	xx	x	x	xxx	xx	x
C.7.0 Public Transportation Improvements											
C.7.1	Electronic Payment Systems	xx	x	xxx	xx	xx	xxx	xx	xx	xxx	xx
C.7.2	Improvements/added capacity to regional rail and bus transit	xx	xx	xxx	xx	xxx	xx	x	xxx	xxx	xx
C.7.3	Improving accessibility to multi-modal options	xx	x	xxx	xx	xxx	xx	xx	xx	xx	xxx
C.7.4	Park-and-ride lot improvements	xx	x	xx	xx	xx	xx	xx	xx	xx	xx
C.7.5	Carsharing Programs	xx	x	xxx	xxx	xxx	xx	xxx	xx	xx	xxx
C.8.0 Pedestrian, bicycle, and multi-modal improvements											
C.8.1	Improve pedestrian facilities	xx	x	xxx	xx	xxx	xx	xx	xx	xx	xxx
C.8.2	Creation of new bicycle and pedestrian lanes and facilities	xx	x	xxx	xxx	xxx	xx	xx	xx	xx	xxx
C.8.3	Addition of bicycle racks at public transit stations/stops	x	x	xx	xxx	xxx	xx	xxx	x	x	xxx
C.8.4	Bike sharing programs	xx	x	xxx	xxx	xxx	xx	xxx	xx	xx	xxx
C.9.0 Growth Management											
C.9.1	Coordination of Regional Activity Centers	xx	x	xxx	xxx	xxx	xx	x	xxx	xxx	xx
C.9.2	Implementation of TLC program (i.e. coordination of transportation and land use with local gov'ts)	xx	x	xxx	xxx	xxx	xx	xxx	x	xxx	xxx
C.9.3	"Live Near Your Work" program	xx	x	xx	xxx	xx	x	xx	x	x	xx

- 1. Some Impact (x)
- 2. Significant Impact (xx)
- 3. High Impact (xxx)

Table L2: Congestion Management Process (CMP) Operational Management Strategies Criteria

STRATEGY		QUALITATIVE CRITERIA									
		Impacts on Congestion					Other Criteria				
		Reduces Overall Congestion	Reduces Incident-related Congestion	Supports/Promotes Multi-modal Transportation	Regional Applicability	Local Applicability	Existing Level of Deployment	Ease of Implementation	Cost	Cost Effectiveness	Enhance Existing Programs
C.1.0 Incident Mngt./Non-recurring											
C.1.1	Imaging/Video for surveillance and Detection	xx	xxx	xx	xxx	xxx	xx	xx	xx	xxx	xxx
C.1.2	Service patrols	xx	xxx	x	xxx	xxx	xx	xxx	xx	xxx	xxx
C.1.3	Emergency Mngt. Systems (EMS)	x	xx	x	xx	xxx	xxx	xx	xxx	xxx	xxx
C.1.4	Emergency Vehicle Preemption	x	xx	x	x	xxx	xx	xx	xx	x	xx
C.1.5	Road Weather Management	x	xxx	x	xxx	xxx	xx	xx	xx	xx	xx
C.1.6	Traffic Mngt. Centers (TMCs)	xx	xxx	xx	xxx	xx	xx	xx	xx	xxx	xxx
C.1.7	Curve Speed Warning System	xx	xx	x	x	xx	x	xx	xx	xx	x
C.1.8	Work Zone Management	xx	xxx	x	xx	xxx	xx	xx	xx	xx	xx
C.1.9	Automated truck rollover systems	x	xx	x	x	xx	xx	xx	xx	xx	xx
C.2.0 ITS Technologies											
C.2.1	Advanced Traffic Signal Systems	xxx	xx	xx	xxx	xxx	xx	xx	xxx	xxx	xxx
C.2.2	Electronic Payment Systems	xxx	x	xx	xxx	xx	xx	xx	xx	xxx	xx
C.2.3	Freeway Ramp Metering	xx	x	x	xx	xx	x	xx	xx	xx	xx
C.2.4	Bus Priority Systems	x	x	xxx	xx	xxx	x	xx	xxx	xx	xx
C.2.5	Lane Management (e.g. Variable Speed Limits)	xx	xx	x	xx	xxx	x	xx	xx	xx	xx
C.2.6	Automated Enforcement (e.g. red light cameras)	x	x	x	x	xxx	xx	xx	xx	xx	xx
C.2.7	Traffic signal timing	xxx	x	xx	xxx	xxx	xx	xxx	x	xxx	xxx
C.2.8	Reversible Lanes	xx	x	x	xx	xxx	x	x	xx	xx	xx
C.2.9	Parking Management Systems	xx	x	xx	xx	xxx	x	x	xxx	xx	xx
C.2.10	Dynamic Routing/Scheduling	xx	x	xx	xxx	xxx	x	x	xxx	xx	xx
C.2.11	Service Coordination and Fleet Mngt. (e.g. buses and trains sharing real-time information)	xx	x	xxx	xxx	xxx	x	x	xx	xx	xx
C.2.12	Probe Traffic Monitoring	xx	xxx	x	xx	xx	x	xx	xx	xxx	xx
C.3.0 Advanced Traveler Information Systems											
C.3.1	511	xx	xxx	xx	xxx	x	xx	xx	xxx	xx	xxx
C.3.2	Variable Message Signs (VMS)	xx	xxx	xx	xx	xxx	xx	xx	xx	xxx	xxx
C.3.3	xxxw ay Advisory Radio (HAR)	x	xx	x	xx	xxx	xx	xxx	xx	x	xx
C.3.4	Transit Information Systems	xx	xx	xxx	xx	xxx	xx	x	xx	xx	xxx
C.4.0 Traffic Engineering Improvements											
C.4.1	Safety Improvements	x	xxx	x	x	xxx	xx	xxx	x	xxx	xxx
C.4.2	Turn Lanes	xx	x	x	x	xxx	xx	xx	xx	xx	x
C.4.3	Roundabouts	x	xx	x	x	xxx	x	x	x	xx	xx

- 1. Some Impact (x)
- 2. Significant Impact (xx)
- 3. High Impact (xxx)

Qualitative Criteria:

The qualitative criteria listed across the top of the lists are used to show what kind of impact strategies have on various areas. The first three criteria listed are all impacts on congestion. However, there are several other criteria that could be looked at to determine if a strategy should be considered. The following is a definition of each criterion, and the questions we may want to ask when giving each strategy a “high,” “medium,” or “low” indicator:

- ***Reduces Overall Congestion***
 - How much of an impact does a strategy have in reducing overall traffic congestion?
- ***Reduces Incident-related Congestion***
 - How much of an impact does a strategy have in reducing incidents and incident-related congestion?
- ***Support/Promotes Multi-modal Transportation***
 - Does this strategy play a particular role in supporting multi-modal transportation, such as the use of bus, rail, bicycling, or pedestrian facilities?
- ***Regional Applicability***
 - Is this the type of strategy that would be easier to implement at the regional level (e.g. alternative commute programs across the region)?
- ***Local Applicability***
 - Is this the type of strategy that would be easier to implement at the local level (e.g. Automated Enforcement, which depends greatly on the local laws and law enforcement)?
- ***Existing Level of Deployment***
 - Is this strategy implemented anywhere in the region now, and if so, to what extent?
- ***Ease of Implementation***
 - How easy is the strategy to implement? Not only in terms of complexity, but in also in terms of funding, and a local jurisdiction’s unique programs and laws. Some strategies are more common and more promising, while others may be more difficult to implement.
- ***Cost***
 - How much does a strategy cost to implement?
- ***Cost Effectiveness***
 - How much does the value outweigh the cost (i.e. how high are the benefits)? This is different than the previous “cost” category. For example, carpooling may be indicated as low in terms of cost, because the cost is generally low to implement. However, carpooling may be indicated as high in terms of cost effectiveness, because the benefits and value gained in the region far outweigh the cost.
- ***Enhance Existing Programs***
 - How well does this strategy fit in with existing strategies in the region? Is it new and something that existing strategies would benefit from? This category, previously broken down into “DC,” “MD,” and “VA,” was collapsed into one category. It was found that when trying to determine if a strategy enhanced existing programs, there was not much variation among the jurisdictions.

Some, Significant, and High Indicators:

Each strategy was given an indicator of “some impact (x),” “significant impact (xx),” or “high impact (xxx),” which was based on a similar nomenclature used in the TERM process. Each indicator was developed from the knowledge and research of what sorts of activities are going on in our region. By nature of various strategies, some will be evaluated with greater or lesser impacts (e.g. a strategy may be listed as “low” for regional applicability but “high” for local applicability”). That being said, some strategies that are “low” in some categories may be of interest for other reasons.

To further explain and clarify the reason for these indicators, let’s walk through the indicators of one strategy, *C.8.1 – Improve Pedestrian Facilities*:

- Improving pedestrian facilities was thought to have a medium impact on reducing overall congestion in the region. Improving pedestrian facilities provides an alternative mode of transportation and takes some cars off the road.
- Its contribution to reducing incident-related congestion is limited; therefore it is indicated low in that category.
- Improving pedestrian facilities greatly support and promote multi-modal transportation, therefore indicated high.
- It is something that can be implemented region-wide, but is more likely to be applied more on a local level, given the unique programs and laws of jurisdictions (thus a medium indicator for regional applicability and a high indicator for local applicability).
- It has a fairly good existing level of deployment across the region (although given the high demand for pedestrian facilities in this region, some areas are lacking facilities).
- Ease of implementation for improving pedestrian facilities could be less expensive than building new roadways, and it could be easier to implement than ITS technologies. However, challenges such as local approval, and demand for these facilities, still remain. Indicator: medium.
- Cost is neither extremely low nor especially high, and it really depends on what type of pedestrian facility is being implemented. Cost effectiveness was indicated medium, as pedestrian facilities provide a good benefit for what it costs to implement them.
- Improvement of pedestrian facilities enhance existing programs. Pedestrian facilities support local growth management plans and provide access to transit options. Indicator: high.

Tying It All Together:

The strategy long lists are important to the regional CMP for several reasons:

- The lists outline various existing and potential strategies that could be considered for our region. As congestion is becoming and epidemic here and elsewhere, these strategies will serve as a point of reference to indicate what is being done in this region to address this.
- The “high,” “medium,” and “low” indicators characterize the impact strategies have. They provide a starting point for discussion show that there are various reasons why one

may want to implement a strategy. While something may have a high cost, it may also have a high impact on reducing congestion and a high cost effectiveness.

- The lists address federal requirements, which state that the region should identify and evaluate anticipated performance and expected benefits of existing strategies.

As the region continues to grow these are just some of the strategies that could be considered for our region. Many strategies on these lists are ongoing and will continue to be implemented on a greater scale. For other strategies these lists may act as a starting point for future consideration. Regardless, congestion management strategies will be at the forefront of discussion as the Washington region continues to be a dynamic living and working environment.

DETAILED DESCRIPTIONS OF STRATEGIES

Following is a list of congestion management strategies listed in the Strategy Long Lists. The numbers correspond with the numbered strategies in the list.

Operational Management Strategies:

C.1.0 - Incident Management./Non-recurring - This category of strategies are aimed at reducing non-recurring congestion; congestion caused primarily by incidents and events. Many of these incident management systems are aimed at clearing an incident so that traffic can resume its normal flow.

- **C.1.1 – Imaging/Video for Surveillance and Detection**
 - Cameras throughout our transportation system, on roadways, at intersections, and at transit stations. Help detect incidents quickly, help emergency response units arrive quickly and help travelers safely negotiate around incidents.
- **C.1.2 – Service Patrols**
 - Specially equipped motor vehicles and trained staff that help in clearing incidents off a roadway and navigating traffic safely around an incident.
- **C.1.3 – Emergency Management Systems (EMS)**
 - EMS notify, dispatch, and guide emergency responders to an incident. Aid in detecting, tracking, and clearing incidents.
- **C. 1.4 – Emergency Vehicle Preemption**
 - Signal preemption for emergency vehicles use sensors to detect and emergency vehicle and provide a green signal to the vehicle. This is important to incident management in that it allows for emergency vehicles to get to the scene of and incident and clear it so that traffic can resume its normal flow.
- **C.1.5 – Road Weather Management**
 - Can take the forms of information dissemination, response and treatment, surveillance monitoring, and prediction, and traffic control. Helps prevent incidents due to inclement weather (snow, ice).
- **C.1.6 – Traffic Management Centers (TMCs)**
 - Centers that collect and analyze traffic data and then disseminate data to the public. Data collection elements might include CCTVs, cameras, and loop detectors. Might relay information to the public through radio, TV, or the Internet. This is important to the public, as it allows them to get information about existing traffic conditions and plan their route and timing accordingly.

- *C.1.7 – Curve Speed Warning System*
 - GPS and digital devices on a highway that assess and detect the threat of vehicles moving toward a curve too quickly. This is important in preventing incidents and thus preventing non-recurring congestion.
- *C.1.8 – Work Zone Management*
 - Can take the form of traffic workers, signs, and temporary road blockers used to direct traffic during an incident or construction. The temporary implementation of traffic management or incident management capabilities can help direct the flow of traffic, keep traffic moving, and prevent additional incidents.
- *C.1.9 – Automated truck rollover systems*
 - Detectors deployed on ramps to warn trucks if they are about to exceed their rollover threshold. If the data concludes a truck’s maximum safe speed is to be exceeded around a turn, then a message sign would flash, “TRUCKS REDUCE SPEED.” This is important in preventing incidents caused by large trucks, and thus preventing non-recurring congestion.

C.2.0 – ITS Technologies – This category of strategies can be defined as electronic technologies and communication devices aimed at monitoring traffic flow, detecting incidents, and providing information to the public and emergency systems on what is happening on our roadways and transit communities. Much of what is done with ITS helps in reducing non-recurring and incident-related congestion, and works hand-in-hand with those strategies listed in the above category (C.1.0).

C.2.1 – Advanced Traffic Signal Systems

- The coordination of traffic signal operation in a jurisdiction, or between jurisdictions. This is important to congestion, as it reduces delay and improves travel times.
- *C.2.2 – Electronic Payment Systems*
 - These systems can make transit use more convenient by allowing a user to pay for bus, rail, park-and-ride lots, and other transit services with one card. Convenience an appealing factor, and helps increase transit ridership and transfers among different transit modes.
- *C.2.3 – Freeway Ramp Metering*
 - Traffic signals on freeway ramps that alternate between red and green to control the flow of vehicles entering the freeway. This prevents incidents that may occur from vehicles entering the freeway too quickly, and also prevents a backup of traffic on the on-ramp.
- *C.2.4 – Bus Priority Systems*
 - Bus priority systems are sensors used to detect approaching transit vehicles and alter signal timings to improve transit performance. For example, some systems extend the duration of green signals for public transportation vehicles when necessary. This is important because improved transit performance, including a more precisely predicted time for bus arrivals, makes public transit a more appealing option for travelers.
- *C.2.5 – Lane Management (e.g. Variable Speed Limits)*

- Variable Speed Limits are sensors used to monitor prevailing weather or traffic conditions, and message signs posting enforceable speed limits. These systems can promote the most effective use of available capacity during emergency evacuations, incidents, construction, and a variety of other traffic and/or weather conditions.
- *C.2.6 – Automated Enforcement (e.g. red light cameras)*
 - Still or video cameras that monitor things such as speed, ramp metering, and the running of red lights, to name a few. They are important to preventing non-recurring and incident related congestion.
- *C.2.7 – Traffic Signal Timing*
 - Traffic signal timing plans adjust traffic signals during an incident, during inclement weather, or to improve transit performance. The overall objective is to reduce backups at traffic signals and to increase the level of service.
- *C.2.8 – Reversible Lanes*
 - Traffic sensors and lane control signs reverse the flow of traffic and allow travel in the peak direction during rush hours. This is important to alleviating congestion that may occur in one direction during a peak hour.
- *C.2.9 – Dynamic Routing/Scheduling*
 - Public transportation routing and scheduling can automatically detect a vehicle's location, and dispatching and reservation technologies can facilitate the flexibility of routing/scheduling. This is can help increase the timeliness of public transportation, keep transit on schedule, which in turn increases ridership.
- *C.2.11 – Service Coordination and Fleet Management (e.g. buses and trains sharing real-time information)*
 - Monitoring and communication technologies in a vehicle that facilitate the coordination of passenger transfers between vehicles or transit systems. This is important and appealing to passengers that use more than one type of transit.
- *C.2.12 – Probe Traffic Monitoring*
 - Using individual vehicles in the traffic stream to measure the time it takes them to travel between two points and also to report abnormal traffic flow caused by incidents. Tracking could be done with the use of cellular phones, and in the future with the installation of a system in the vehicle which would send information to transportation operators. This is important to monitoring recurring and non-recurring congested locations, and travel time.

C.3.0 – Advanced Traveler Information Systems – Provide information to travelers which allow them to adjust the timing of their travels or the route that they take to avoid any incidents, construction, or weather problems.

- *C.3.1 – 511*
 - A variety of applications for travelers to use either before their trip or en-route, such as 511 telephone systems, internet websites, pagers, cell phones, and radio, to obtain up-to-date traveler information. This helps travelers plan their timing and routes accordingly.
- *C.3.2 – Variable Message Signs (VMS)*
 - One way ITS operators can share traffic information with travelers is through a Variable Message Sign (VMS) along the roadway. Such signs could provide

information on road closures, emergency messages, weather message, and construction. This helps travelers plan their timing and routes accordingly. These signs can also prevent incidents from occurring as they provide warnings about speed, weather, construction, etc.

- **C.3.3 – Highway Advisory Radio (HAR)**
 - Another way ITS operators can share traffic information with travelers is through Highway Advisory Radio (HAR). The radio can provide information on road closures, emergency messages, weather, and construction (such as the Woodrow Wilson Bridge Project). Travelers can plan their timing and route accordingly.
- **C.3.4 – Transit Information Systems**
 - Can provide up-to-date transit information, such as arrival times for bus and rail. The WMATA Metrorail display signs depicting arrival times for trains are examples of this. Having this type of information available can increase transit ridership, and can also allow riders to make decisions on what type of transit to use based on up-to-date information.

C.4.0 – Traffic Engineering Improvements – Improvements implemented on roadways where congestion problems have occurred in the past or are anticipated to occur in the future. Some of these engineering improvements can be aimed at reducing incidents on a particularly dangerous section of roadway, while others may be attempting to relieve a choke-point or bottleneck.

- **C.4.1 – Safety Improvements**
 - Improvements done to increase safety and reduce incident-related congestion. Examples of some improvements include traffic calming devices, speed bumps, widening or narrowing a roadway, and textured pavement. These safety improvements can prevent incidents and non-recurring congestion resulting from incidents.
- **C.4.2 – Turn lanes**
 - Might be implemented to reduce the queuing of cars waiting to make a right or left turn at an intersection, thus reducing congestion.
- **C.4.3 – Roundabouts**
 - Barriers placed in the middle of an intersection, creating a circle, and thus directing vehicles in the same direction. This can help reduce congestion by slowing the speed of cars on a street and/or preventing thru traffic on a neighborhood street.

Demand Management Strategies:

C.5.0 – Alternative Commute Programs – Provides travelers with options other than the single-occupant vehicle. These programs are aimed in reducing the amount of single-occupant vehicles are on our roadways.

- **C.5.1 – Carpooling**
 - Two or more people traveling together in one vehicle. This reduces the amount of vehicles on the road.
- **C.5.2 – Ridematching Services**
 - Enables commuters to find other individuals that share the same commute route and can carpool/vanpool together. This provides carpooling options for people

who may not know of someone to carpool with, thus broadening the carpooling option.

- *C.5.3 – Vanpooling*
 - When a group of individuals (usually long-distance commuters) travel together by van, which is sometimes provided by employers. This reduces the amount of vehicles on the road, which is especially important for long-distance transportation modes.
- *C.5.4 – Telecommuting*
 - Workers either work from home or from a regional telecommute center for one or more days of the week. This reduces the amount of vehicles on the road, especially during rush hour when many commuters are going to work at once.
- *C.5.5 – Promote Alternate Modes*
 - Programs, such as Commuter Connections, or regional Transportation Management Areas (TMAs) provide information to the public on alternative commute programs. This gets the word out about commute options in the region, many who may not have considered alternative commute programs as an option before.
- *C.5.6 – Compressed/flexible workweeks*
 - Employees compressing their work week into a shorter number of days, which allows them to avoid commuting one or more days a week. This reduces the amount of vehicles on the road.
- *C.5.7 – Employer outreach/mass marketing*
 - Organizations, such as Commuter Connections, providing information to employers on the benefits of alternative commute programs for their employees. This allows employers to see the benefits that alternative commute programs can have in their organization.
- *C.5.8 – Parking cash-out*
 - Employees essentially pay their employees not to park at work. The employees receive compensation for the parking space they would have otherwise used if they did not walk, bike, take transit, etc. This encourages more people to leave their car at home in favor of another mode of transportation.
- *C.5.9 – Alternative Commute Subsidy Program*
 - Employees provide a transit subsidy to their employees, which encourages them to use public transit instead of driving to work. This reduces the amount of vehicles on the road.

C.6.0 – Managed Facilities – These facilities have restrictions for use of the roadways. In some cases, only those other than single-occupant vehicles can use the lane or roadway. In other cases, a fee is implemented for single-occupant vehicles. Still, in other case, a fee might be implemented for every car on the roadway entering a city. They all have a common goal of reducing the amount of single-occupant vehicles on the roadways and promoting other forms of transportation.

- *C.6.1 - HOV*

- High Occupancy Vehicle (HOV) are lanes reserved for vehicles with a driver and one or more passengers. This promotes the use of carpools, which can use a less-congested lane on the highway.
- *C.6.2- Variably Priced Lanes (VPL)*
 - Lanes which are typically used by carpools for free, while solo drivers pay tolls that change according to varying congestion levels. This encourages the use of carpooling, but also raises revenue for additional transportation projects that would reduce congestion.
- *C.6.3 – Cordon Pricing*
 - Cordon area congestion pricing is a fee paid by users to enter a restricted area in the city center. This is a way of promoting other alternative modes of transportation, while raising revenue for other transportation projects that would reduce congestion.
- *C.6.4 – Bridge Tolling*
 - Tolling over a bridge, in either one or both directions. This may decrease congestion on a bridge, as people may find an alternative route in lieu of paying the fee. Also, it raises revenue for transportation projects that would help in reducing congestion.

C.7.0 – Public Transportation Improvements – These improvements are done to the region’s public transportation to ensure that it remains a safe and viable mode for travelers. Improvements can maintain the amount of users and attract new ones who never considered public transit as an option before.

- *C.7.1 – Electronic Payment Systems*
 - These systems can make transit use more convenient by allowing a user to pay for bus, rail, park-and-ride lots, and other transit services with one card. Convenience an appealing factor, and helps increase transit ridership and ridership between different transit modes.
- *C.7.2 – Improvements/added capacity to regional rail and bus transit*
 - Added capacity and improvements to rail and bus to help keep up with increasing demand on public transportation. This is important in keeping with the growing demand on public transportation as an alternative mode.
- *C.7.3 – Improving accessibility to multi-modal options*
 - Ensuring that connections are provided to multi-modal options, such as bus, rail, and pedestrian and bicycle facilities. More connections makes it easier for people to access multi-modal options, thus increasing use.
- *C.7.4 – Park-and-Ride Lot Improvements*
 - Improvements to park-and-ride lots to keep up with increasing demand and growth in the region. Park-and-Ride lots allow people to access public transportation, who may not be able to access it from their home. Improvements to these lots can ensure that this growing need is met and that people can continue to have transit access.
- *C.7.5 – Carsharing Programs*
 - A convenient and cost-effective mobility option for those that typically do not have a need to own a car. This reduces the amount of cars on the road because

generally the car is only used when needed, and public transportation or other modes are used most of the time.

C.8.0 – Pedestrian, Bicycle, and Multi-modal Improvements – Maintaining and creating new pedestrian, bicycle, and multi-modal facilities is improvement in that it improves accessibility. If something is accessible by a walk or bike path, people are more likely to leave their car at home.

- **C.8.1- Improve Pedestrian Facilities**
 - Improvement and addition of new pedestrian and bicycle facilities to keep up with a growing demand and ensure safety for users. This ensures that those using these facilities will continue to do so, and that potential users will find pedestrian facilities more appealing and accessible.
- **C.8.2 – Creation of new bicycle and pedestrian lanes and facilities**
 - Addition of new lanes to keep up with a growing demand and created new connections throughout the region. This will extend the option of bicycle and pedestrian lanes to those that may not already have access to it, as well as provide increased access to employment, recreation, retail, and housing in the region.
- **C.8.3 – Addition of bicycle racks at public transit stations/stops**
 - Allows people who bike to connect to other forms of transportation. This gives people another option for traveling other than a single-occupant vehicle.
- **C.8.4 – Bike sharing Programs**
 - A convenient and cost-effective mobility option for those that typically do not have a need to own a bicycle. This allows people to shift easily from other forms of transport to bicycle and back again.

C.9.0 – Growth Management – Growth Management is the term used in the Federal Rule, but really this term pertains to ensuring the coordination of transportation and land use. In terms of Growth Management we are talking about making sure that everyone has the option to public transportation and alternative modes no matter where they live or work in the region.

- **C.9.1 – Coordination of Regional Activity Centers**
 - Help coordinate transportation and land use planning in specific areas in the Washington region experiencing and anticipating growth. Focusing growth in Regional Activity Centers is important to congestion management, where transportation options for those who live and work there can be provided.
- **C.9.2 – Implementation of TLC program (i.e. coordination of transportation and land use with local governments).**
 - Provides support and assistance to local governments in the Washington region as they implement their own strategies to improve coordination between transportation and land use. The idea is to provide public transit options to everyone in the region.
- **C.9.3 – “Live Near Your Work” program**
 - Supporting the idea that locating jobs and housing closer together can provide alternative commuting options that may not have been options otherwise.